

# Cinch



# CIN::APSE®

High Speed  
Interconnect Technology



**Cinch**

FEATURES

- *High signal speed capability enabling frequencies greater than 20 GHz.*
- *Z-Axis, solderless, compression mount interconnect system.*
- *Applications include production Land Grid Array (LGA) integrated circuit sockets, flex circuit to PCB, and parallel PCB to PCB interconnections.*
- *Provides solutions to many of the problems associated with through hole and surface mount soldered technology.*
- *Enables upgrade and system maintenance strategies.*
- *Available in custom I/O configurations and I/O counts from 1 to over 5,000.*
- *Offers low profile capabilities with compressed signal path length as short as 0.8 mm.*
- *Contact centerline spacing of 1mm or greater.*
- *Excellent reliability in commercial, military, and aerospace applications.*
- *Application can result in lower installed and system maintenance costs.*

MATERIALS

**Contact Material:** Molybdenum  
**CIN::APSE Contact Plating:** Gold  
**Plunger Material:** Copper alloy  
**Plunger Plating:** Gold  
**Insulator Material:** Liquid crystal polymer  
**Packaging Tray Material:** Anti-static ABS

ENVIRONMENTAL

**Button-Only Configuration with 0.020" (0.5 mm) Diameter**  
**Temperature Life Testing:** 1000 Hours @ 200°C  
**Thermal Shock:** 2,000 Cycles @ 20°C to 110°C  
**Humidity:** 5,000 Hours @ 30°C to 80°C, 80% RH  
**Salt Spray:** 96 Hours  
**Low Temperature:** Operates in liquid nitrogen (77°K)  
**Bellcore TR-NWT-001217:** Passed with plungers

ELECTRICAL

**Button-Only Configuration with 0.020" (0.5 mm) Diameter**

|   |                       |
|---|-----------------------|
| <b>DC Resistance:</b>                   | 15mΩ average          |
| <b>Inductance:</b>                      | Less than 1 nH        |
| <b>Current-Carrying Capability:</b>     | Up to 3 Amps.         |
| <b>Insulation Resistance:</b>           | 25,000 MegΩ @ 500 VDC |
| <b>Dielectric Withstanding Voltage:</b> | 900 VAC at sea level  |

MECHANICAL

**Button-Only Configuration with 0.020" (0.5 mm) diameter**  
**Durability:** 25,000 Z-axis actuations (CIN::APSE contact only)  
**Shock:** 100 Gs; 6 milliseconds, no discontinuity greater than 2 nanoseconds  
**Vibration:** 20 Gs; 10-20,000 Hz; no discontinuity greater than 2 nanoseconds



IC Component to Board Socket (LGA)



Flex Circuit to PCB

**THE BUTTON CONTACT**

The unique construction of the CIN::APSE contact provides superior mechanical and electrical performance. It is constructed of randomly wound molybdenum wire that is formed into a cylindrical shape. Standard CIN::APSE contact diameters are 0.020" and 0.040".

**Mechanical**

- Small form factor (0.020" diameter by 0.32" min. high)
- Low compression force (approx. 2.5 oz. min. per contact)
- Multiple beam structures
- Several points of contact per button
- Extremely lightweight
- Natural wiping action

**Electrical**

- Short signal path
- Very low inductance and resistance
- Signal integrity tested in the GHz range



**Typical CIN::APSE Applications**

- LGA package I/O to PC board (IC packages, multi-chip modules)
- PC board to PC board (parallel processors, enhancement/mezzanine cards)
- Flex circuit to PC board (rigid flex, harnessing)
- Flex circuit to ceramic (chip to harness)

**CIN::APSE APPLIED**

The basic button contact configuration consists of a single button installed in our patented "hourglass" design.

The hourglass cavity retains the CIN::APSE contact securely. Typically 0.003" protrudes from the top and the bottom of the insulator.

**Step 1:**  
 Using alignment features, position the CIN::APSE connector between a LGA chip package and PCB or two PCBs that have matching footprints.

**Step 2:**  
 Add Z-Axis compression and secure.

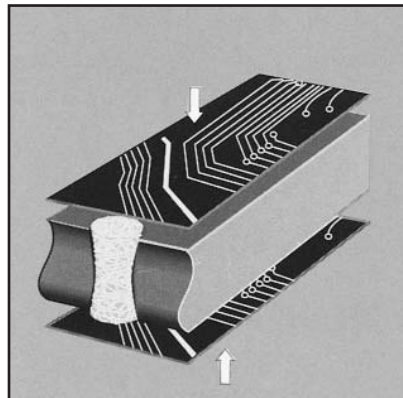

# 1

## TYPICAL CONFIGURATION

### 1. Button-Only

This is the basic CIN::APSE contact configuration. It is ideally suited for z-axis applications requiring minimum height, high density, and signal integrity. This configuration is used in LGA and IC sockets, PCB to PCB, and flex print circuit to PCB applications.

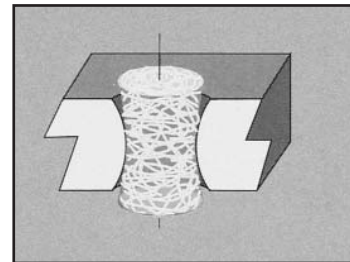

### 2. Plunger-Button

The addition of a gold-plated brass plunger increases the durability of the CIN::APSE contact system while also achieving additional height. This configuration suits itself especially well for PCB to PCB interconnect and those that require excessive handling.



*Other custom configurations are available. Contact Cinch for details.*

## CIN::APSE Applications

Due to its breakthrough nature, it is impossible to illustrate all of the applications CIN::APSE technology can address. The following applications illustrate only a portion of the types of interconnect problems that CIN::APSE can solve.

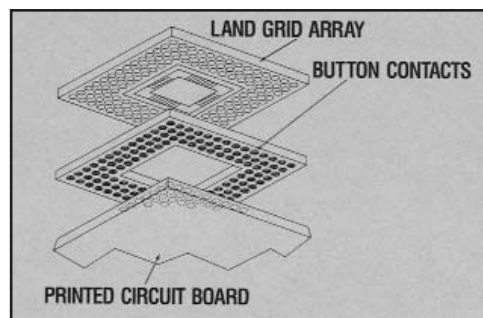

VARIOUS CIN::APSE APPLICATIONS



IC Component to Board Socket (LGA)



PCB to PCB



Hybrid Circuit to Flex to PCB



LCD to Flex to PCB



Cable to PCB/Flex



Flex Circuit to PCB

# COMMERCIAL

Barrier Blocks  
Circular Mini DIN  
BNC

Jones Plugs  
Edge Connectors



**Cinch**

Cinch Commercial Products, consisting of Jones Plugs and Sockets, Barrier Blocks, Edge Cards, Two-Piece Commercial Dins, Mini Din Plugs, and their newest addition the 75Ω Press-Fit BNC Receptacle, provide a wide variety of connectors for the purchaser and designer to choose from.

The Jones Plugs and Sockets have been utilized for decades and provide a quick, reliable, and economical means of solving your higher current-carrying capacity needs. Available in two series (300 and 2,400), these connectors can be found in data processing controls; amusement and vending machines; medical, communication, and test equipment; as well as industrial controls and heavy-duty, battery-powered equipment. Both series are available in a variety of cable and panel mounting options.

Cinch Barrier Blocks are designed to simplify wiring work by reducing splicing, preventing current leaks and short circuits, and increasing insulation. Available in a variety of densities, these barrier blocks can be found in applications ranging from industrial controls to switching systems.

Designed specially for applications where space is at a premium, the Cinch Mini Din family is ideal for personal computers, keyboard-mouse interface, hand-held electronic equipment, office-automation equipment, and audio and video equipment. Available in sizes 3 through 8 contact, the Cinch Mini Din family includes a fully shielded cable mounted plug in various cable lengths or cable mounted plug components for customers with high-volume assembly and overmold capabilities.

Cinch Edge Card Connectors are available in a variety of styles on both .100 or .156 center spacing.

The newest addition to the commercial family, the 75Ω Press-Fit BNC Receptacle is designed around a unique patented press-fit design that allows for multiple insertion into a backplane without loss of mechanical retention or electrical performance.

When looking for time reliability to solve your commercial interconnect needs, look no further than Cinch Connectors. Whether it's a Jones Plug and Socket, Barrier Block, Edge Card, Mini Din plug, or our newest addition, the 75Ω BNC Press-Fit connector, you will always know years of customer satisfaction stand behind the product you choose.



## FEATURES

- *Interposing barriers between terminals yield higher electrical ratings and provide additional protection against frayed wire shorting.*
- *A wide variety of barrier blocks makes it possible to select the combination of mechanical and electrical characteristics that best meet the exact requirements of your application.*
- *A wide selection of optional terminals and fanning strips permits the equipment designer to choose the method of termination most suitable for his environmental specifications and manufacturing requirements.*

## MATERIALS

**Insulation Material:** Molded monoblock, general purpose phenolic, black, UL Rated 94V-1

**Eyelets:** Material - Brass  
Plating - Nickel

**Screws:** Material - Steel  
Plating - Nickel over copper flash

**Solder Terminals:** Material - Brass  
Plating - Electro-Tin

**Marker Strip Material:** Nema Grade XPC, UL Rated 94V-0



## ENVIRONMENTAL

**Operating Temperature:** -55° to +300°F

**Certifications:** UL Recognized - File E61245  
CSA - LR 31996



Marketed exclusively through distribution.

## TERMINAL BLOCK QUICK REFERENCE

| Series | Center-to-Center Spacing | Number of Terminals | Single or Double Row | Screw Size | Operating Voltage | Current Rating | Max. Wire Size | Max. Watts/Terminal | Voltage Rating w/Marker | Voltage Rating w/o Marker | Marker Strip Mounting |
|--------|--------------------------|---------------------|----------------------|------------|-------------------|----------------|----------------|---------------------|-------------------------|---------------------------|-----------------------|
| 140    | .375                     | 1-25                | Double               | 5-40       | 250 Volts         | 15 Amps        | #16            | 3750                | 2000                    | 1100                      | Bottom                |
| 141    | .438                     | 1-20                | Double               | 6-32       | 250 Volts         | 20 Amps        | #14            | 5000                | 2400                    | 1100                      | Bottom                |
| 142    | .563                     | 1-17                | Double               | 8-32       | 250 Volts         | 30 Amps        | #10            | 7500                | 2600                    | 1600                      | Bottom                |
| 150    | .688                     | 1-10                | Double               | 10-32      | 250 Volts         | 40 Amps        | #10            | 10,000              | 2400                    | 1500                      | Bottom                |
| 151    | .875                     | 1-8                 | Double               | 12-32      | 250 Volts         | 50 Amps        | #8             | 12,500              | 3400                    | 1800                      | Bottom                |
| 152    | 1.125                    | 1-6                 | Double               | 1/4-28     | 250 Volts         | 70 Amps        | #6             | 54,000              | 3800                    | 2100                      | Bottom                |
| 164    | .375                     | 1-21                | Double               | 6-32       | 250 Volts         | 15 Amps        | #14            | 3750                | 2000                    | 1100                      | Bottom                |
| 540    | .375                     | 2-31                | Double               | 5-40       | 600 Volts         | 15 Amps        | #16            | 3750                | 2300                    | 2300                      | Top                   |
| 541    | .438                     | 2-30                | Double               | 6-32       | 600 Volts         | 20 Amps        | #14            | 5000                | 2800                    | 2800                      | Top                   |
| 542    | .563                     | 2-26                | Double               | 8-32       | 600 Volts         | 30 Amps        | #10            | 7500                | 4000                    | 4000                      | Top                   |
| 176    | .375                     | 2-10                | Single               | 5-40       | 250 Volts         | 15 Amps        | #16            | 3750                | N/A                     | 1100                      | N/A                   |

Marketed exclusively through distribution.

# Barrier Blocks Series 140

.375 Density, 5-40 x 3/16"  
BH Screw, Open Bottom,  
Double Row



### Electrical Characteristics

**Voltage Rating:** 250 VAC RMS maximum  
**Current Rating:** 15 Amps maximum  
**Maximum Watts Per Terminal:** 3750

### Mechanical Characteristics

**Maximum Wire Size:** #16 AWG  
**Recommended Tightening Torque:** 9 lb.-in.



### Dimensions



### Ordering Information

| No. of Terminals | Standard Screw Catalog No. | "M" Dim. | "L" Dim. |
|------------------|----------------------------|----------|----------|
| 1                | 1-140                      | .750     | 1.032    |
| 2                | 2-140                      | 1.125    | 1.407    |
| 3                | 3-140                      | 1.500    | 1.782    |
| 4                | 4-140                      | 1.875    | 2.157    |
| 5                | 5-140                      | 2.250    | 2.532    |
| 6                | 6-140                      | 2.625    | 2.907    |
| 7                | 7-140                      | 3.000    | 3.282    |
| 8                | 8-140                      | 3.375    | 3.657    |
| 9                | 9-140                      | 3.750    | 4.032    |
| 10               | 10-140                     | 4.125    | 4.407    |
| 11               | 11-140                     | 4.500    | 4.782    |
| 12               | 12-140                     | 4.875    | 5.157    |
| 13               | 13-140                     | 5.250    | 5.532    |
| 14               | 14-140                     | 5.625    | 5.907    |
| 15               | 15-140                     | 6.000    | 6.282    |
| 16               | 16-140                     | 6.375    | 6.657    |
| 17               | 17-140                     | 6.750    | 7.032    |
| 18               | 18-140                     | 7.125    | 7.407    |
| 19               | 19-140                     | 7.500    | 7.782    |
| 20               | 20-140                     | 7.875    | 8.157    |
| 21               | 21-140                     | 8.250    | 8.532    |
| 22               | 22-140                     | 8.625    | 8.907    |
| 23               | 23-140                     | 9.000    | 9.282    |
| 24               | 24-140                     | 9.375    | 9.657    |
| 25               | 25-140                     | 9.750    | 10.032   |

# Barrier Blocks Series 140

.375 Density, 5-40 x 3/16"  
BH Screw, Open Bottom,  
Double Row



## Solder Terminal Options

## Dimensions

“Y” Terminals



“3/4W” Terminals



“W” Terminals

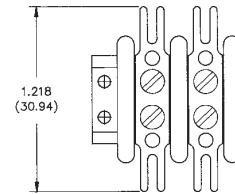

## Ordering Information

| No. of Terminals | Catalog No. | Catalog No. | Catalog No. |
|------------------|-------------|-------------|-------------|
| 1                | 1-140-Y     | 1-140-3/4W  | 1-140-W     |
| 2                | 2-140-Y     | 2-140-3/4W  | 2-140-W     |
| 3                | 3-140-Y     | 3-140-3/4W  | 3-140-W     |
| 4                | 4-140-Y     | 4-140-3/4W  | 4-140-W     |
| 5                | 5-140-Y     | 5-140-3/4W  | 5-140-W     |
| 6                | 6-140-Y     | 6-140-3/4W  | 6-140-W     |
| 7                | 7-140-Y     | 7-140-3/4W  | 7-140-W     |
| 8                | 8-140-Y     | 8-140-3/4W  | 8-140-W     |
| 9                | 9-140-Y     | 9-140-3/4W  | 9-140-W     |
| 10               | 10-140-Y    | 10-140-3/4W | 10-140-W    |
| 11               | 11-140-Y    | 11-140-3/4W | 11-140-W    |
| 12               | 12-140-Y    | 12-140-3/4W | 12-140-W    |
| 13               | 13-140-Y    | 13-140-3/4W | 13-140-W    |
| 14               | 14-140-Y    | 14-140-3/4W | 14-140-W    |
| 15               | 15-140-Y    | 15-140-3/4W | 15-140-W    |
| 16               | 16-140-Y    | 16-140-3/4W | 16-140-W    |
| 17               | 17-140-Y    | 17-140-3/4W | 17-140-W    |
| 18               | 18-140-Y    | 18-140-3/4W | 18-140-W    |
| 19               | 19-140-Y    | 19-140-3/4W | 19-140-W    |
| 20               | 20-140-Y    | 20-140-3/4W | 20-140-W    |
| 21               | 21-140-Y    | 21-140-3/4W | 21-140-W    |
| 22               | 22-140-Y    | 22-140-3/4W | 22-140-W    |
| 23               | 23-140-Y    | 23-140-3/4W | 23-140-W    |
| 24               | 24-140-Y    | 24-140-3/4W | 24-140-W    |
| 25               | 25-140-Y    | 25-140-3/4W | 25-140-W    |

Solder Terminals can be ordered separately.

| Terminal Type | Catalog No. |
|---------------|-------------|
| “Y”           | Y-140       |
| “3/4W”        | 3/4W-140    |
| “W”           | W-140       |

Marketed exclusively through distribution.

# Barrier Blocks Series 140

.375 Density, 5-40 x 3/16"  
BH Screw, Open Bottom,  
Double Row



## Marker Strips

### Dimensions

Standard

"Y" Terminal



## Ordering Information

| No. of Terminals | Catalog No. | Catalog No. |
|------------------|-------------|-------------|
| 1                | MS-1-140    | MS-1-140-Y  |
| 2                | MS-2-140    | MS-2-140-Y  |
| 3                | MS-3-140    | MS-3-140-Y  |
| 4                | MS-4-140    | MS-4-140-Y  |
| 5                | MS-5-140    | MS-5-140-Y  |
| 6                | MS-6-140    | MS-6-140-Y  |
| 7                | MS-7-140    | MS-7-140-Y  |
| 8                | MS-8-140    | MS-8-140-Y  |
| 9                | MS-9-140    | MS-9-140-Y  |
| 10               | MS-10-140   | MS-10-140-Y |
| 11               | MS-11-140   | MS-11-140-Y |
| 12               | MS-12-140   | MS-12-140-Y |
| 13               | MS-13-140   | MS-13-140-Y |
| 14               | MS-14-140   | MS-14-140-Y |
| 15               | MS-15-140   | MS-15-140-Y |
| 16               | MS-16-140   | MS-16-140-Y |
| 17               | MS-17-140   | MS-17-140-Y |
| 18               | MS-18-140   | MS-18-140-Y |
| 19               | MS-19-140   | MS-19-140-Y |
| 20               | MS-20-140   | MS-20-140-Y |
| 21               | MS-21-140   | MS-21-140-Y |
| 22               | MS-22-140   | MS-22-140-Y |
| 23               | MS-23-140   | MS-23-140-Y |
| 24               | MS-24-140   | MS-24-140-Y |
| 25               | MS-25-140   | MS-25-140-Y |

Use Standard Marker Strips for "3/4W" and "W" Solder Terminals.

## Accessories

- Jumpers
- Fanning Strips

Marketed exclusively through distribution.

# Barrier Blocks Series 141

.438 Density, 6-32 x 1/4"  
BH Screw, Open Bottom,  
Double Row



## Electrical Characteristics

**Voltage Rating:** 250 VAC RMS maximum  
**Current Rating:** 20 Amps maximum  
**Maximum Watts Per Terminal:** 5000

## Mechanical Characteristics

**Maximum Wire Size:** #14 AWG  
**Recommended Tightening Torque:** 12 lb.-in.

## Dimensions



## Ordering Information

| No. of Terminals | Standard Screw Catalog No. | "M" Dim. | "L" Dim. |
|------------------|----------------------------|----------|----------|
| 1                | 1-141                      | .875     | 1.187    |
| 2                | 2-141                      | 1.312    | 1.625    |
| 3                | 3-141                      | 1.750    | 2.062    |
| 4                | 4-141                      | 2.187    | 2.500    |
| 5                | 5-141                      | 2.625    | 2.938    |
| 6                | 6-141                      | 3.062    | 3.375    |
| 7                | 7-141                      | 3.500    | 3.812    |
| 8                | 8-141                      | 3.938    | 4.250    |
| 9                | 9-141                      | 4.375    | 4.687    |
| 10               | 10-141                     | 4.813    | 5.125    |
| 11               | 11-141                     | 5.250    | 5.562    |
| 12               | 12-141                     | 5.687    | 6.000    |
| 13               | 13-141                     | 6.125    | 6.437    |
| 14               | 14-141                     | 6.562    | 6.875    |
| 15               | 15-141                     | 7.000    | 7.312    |
| 16               | 16-141                     | 7.437    | 7.750    |
| 17               | 17-141                     | 7.875    | 8.187    |
| 18               | 18-141                     | 8.312    | 8.625    |
| 19               | 19-141                     | 8.750    | 9.062    |
| 20               | 20-141                     | 9.187    | 9.500    |

Marketed exclusively through distribution.

# Barrier Blocks Series 141

.438 Density, 6-32 x 1/4"  
BH Screw, Open Bottom,  
Double Row



## Solder Terminal Options

### Dimensions

"Y" Terminals



"3/4W" Terminals



"W" Terminals



## Ordering Information

| No. of Terminals | Catalog No. | Catalog No. | Catalog No. |
|------------------|-------------|-------------|-------------|
| 1                | 1-141-Y     | 1-141-3/4W  | 1-141-W     |
| 2                | 2-141-Y     | 2-141-3/4W  | 2-141-W     |
| 3                | 3-141-Y     | 3-141-3/4W  | 3-141-W     |
| 4                | 4-141-Y     | 4-141-3/4W  | 4-141-W     |
| 5                | 5-141-Y     | 5-141-3/4W  | 5-141-W     |
| 6                | 6-141-Y     | 6-141-3/4W  | 6-141-W     |
| 7                | 7-141-Y     | 7-141-3/4W  | 7-141-W     |
| 8                | 8-141-Y     | 8-141-3/4W  | 8-141-W     |
| 9                | 9-141-Y     | 9-141-3/4W  | 9-141-W     |
| 10               | 10-141-Y    | 10-141-3/4W | 10-141-W    |
| 11               | 11-141-Y    | 11-141-3/4W | 11-141-W    |
| 12               | 12-141-Y    | 12-141-3/4W | 12-141-W    |
| 13               | 13-141-Y    | 13-141-3/4W | 13-141-W    |
| 14               | 14-141-Y    | 14-141-3/4W | 14-141-W    |
| 15               | 15-141-Y    | 15-141-3/4W | 15-141-W    |
| 16               | 16-141-Y    | 16-141-3/4W | 16-141-W    |
| 17               | 17-141-Y    | 17-141-3/4W | 17-141-W    |
| 18               | 18-141-Y    | 18-141-3/4W | 18-141-W    |
| 19               | 19-141-Y    | 19-141-3/4W | 19-141-W    |
| 20               | 20-141-Y    | 20-141-3/4W | 20-141-W    |

Solder Terminals can be ordered separately.

| Terminal Type | Catalog No. |
|---------------|-------------|
| "Y"           | Y-141       |
| "3/4W"        | 3/4W-141    |
| "W"           | W-141       |

Marketed exclusively through distribution.

# Barrier Blocks Series 141

.438 Density, 6-32 x 1/4"  
BH Screw, Open Bottom,  
Double Row



2

## Marker Strips

## Dimensions



## Ordering Information

| No. of Terminals | Catalog No. | Catalog No. |
|------------------|-------------|-------------|
| 1                | MS-1-141    | MS-1-141-Y  |
| 2                | MS-2-141    | MS-2-141-Y  |
| 3                | MS-3-141    | MS-3-141-Y  |
| 4                | MS-4-141    | MS-4-141-Y  |
| 5                | MS-5-141    | MS-5-141-Y  |
| 6                | MS-6-141    | MS-6-141-Y  |
| 7                | MS-7-141    | MS-7-141-Y  |
| 8                | MS-8-141    | MS-8-141-Y  |
| 9                | MS-9-141    | MS-9-141-Y  |
| 10               | MS-10-141   | MS-10-141-Y |
| 11               | MS-11-141   | MS-11-141-Y |
| 12               | MS-12-141   | MS-12-141-Y |
| 13               | MS-13-141   | MS-13-141-Y |
| 14               | MS-14-141   | MS-14-141-Y |
| 15               | MS-15-141   | MS-15-141-Y |
| 16               | MS-16-141   | MS-16-141-Y |
| 17               | MS-17-141   | MS-17-141-Y |
| 18               | MS-18-141   | MS-18-141-Y |
| 19               | MS-19-141   | MS-19-141-Y |
| 20               | MS-20-141   | MS-20-141-Y |

Use Standard Marker Strip for "3/4W" and "W" Solder Terminals.

## Accessories

- Jumpers
- Fanning Strips

Marketed exclusively through distribution.



# Barrier Blocks Series 142

.563 Density, 8-32 x 5/16"  
BH Screw, Open Bottom,  
Double Row



## Electrical Characteristics

**Voltage Rating:** 250 VAC RMS maximum

**Current Rating:** 30 Amps maximum

**Maximum Watts Per Terminal:** 7500

## Mechanical Characteristics

**Maximum Wire Size:** #10 AWG

**Recommended Tightening Torque:** 16 lb.-in.



## Dimensions



## Ordering Information

| No. of Terminals | Standard Screw Catalog No. | "M" Dim. | "L" Dim. |
|------------------|----------------------------|----------|----------|
| 1                | 1-142                      | 1.125    | 1.531    |
| 2                | 2-142                      | 1.687    | 2.094    |
| 3                | 3-142                      | 2.250    | 2.656    |
| 4                | 4-142                      | 2.812    | 3.219    |
| 5                | 5-142                      | 3.375    | 3.781    |
| 6                | 6-142                      | 3.937    | 4.344    |
| 7                | 7-142                      | 4.500    | 4.906    |
| 8                | 8-142                      | 5.062    | 5.468    |
| 9                | 9-142                      | 5.625    | 6.031    |
| 10               | 10-142                     | 6.187    | 6.594    |
| 11               | 11-142                     | 6.750    | 7.156    |
| 12               | 12-142                     | 7.312    | 7.719    |
| 13               | 13-142                     | 7.875    | 8.281    |
| 14               | 14-142                     | 8.437    | 8.844    |
| 15               | 15-142                     | 9.000    | 9.406    |
| 16               | 16-142                     | 9.562    | 9.969    |
| 17               | 17-142                     | 10.125   | 10.531   |

Marketed exclusively through distribution.

# Barrier Blocks Series 142

.563 Density, 8-32 x 5/16"  
BH Screw, Open Bottom,  
Double Row



## Solder Terminal Options

### Dimensions

“Y” Terminals



“3/4W” Terminals



“W” Terminals



## Ordering Information

| No. of Terminals | Catalog No. | Catalog No. | Catalog No. |
|------------------|-------------|-------------|-------------|
| 1                | 1-142-Y     | 1-142-3/4W  | 1-142-W     |
| 2                | 2-142-Y     | 2-142-3/4W  | 2-142-W     |
| 3                | 3-142-Y     | 3-142-3/4W  | 3-142-W     |
| 4                | 4-142-Y     | 4-142-3/4W  | 4-142-W     |
| 5                | 5-142-Y     | 5-142-3/4W  | 5-142-W     |
| 6                | 6-142-Y     | 6-142-3/4W  | 6-142-W     |
| 7                | 7-142-Y     | 7-142-3/4W  | 7-142-W     |
| 8                | 8-142-Y     | 8-142-3/4W  | 8-142-W     |
| 9                | 9-142-Y     | 9-142-3/4W  | 9-142-W     |
| 10               | 10-142-Y    | 10-142-3/4W | 10-142-W    |
| 11               | 11-142-Y    | 11-142-3/4W | 11-142-W    |
| 12               | 12-142-Y    | 12-142-3/4W | 12-142-W    |
| 13               | 13-142-Y    | 13-142-3/4W | 13-142-W    |
| 14               | 14-142-Y    | 14-142-3/4W | 14-142-W    |
| 15               | 15-142-Y    | 15-142-3/4W | 15-142-W    |
| 16               | 16-142-Y    | 16-142-3/4W | 16-142-W    |
| 17               | 17-142-Y    | 17-142-3/4W | 17-142-W    |

Solder Terminals can be ordered separately.

### Terminal Type

“Y”  
“3/4W”  
“W”

### Catalog No.

Y-142  
3/4W-142  
W-142

Marketed exclusively through distribution.

# Barrier Blocks Series 142

.563 Density, 8-32 x 5/16"  
BH Screw, Open Bottom,  
Double Row



## Marker Strips

## Dimensions



## Ordering Information

| No. of Terminals | Catalog No. | Catalog No. |
|------------------|-------------|-------------|
| 1                | MS-1-142    | MS-1-142-Y  |
| 2                | MS-2-142    | MS-2-142-Y  |
| 3                | MS-3-142    | MS-3-142-Y  |
| 4                | MS-4-142    | MS-4-142-Y  |
| 5                | MS-5-142    | MS-5-142-Y  |
| 6                | MS-6-142    | MS-6-142-Y  |
| 7                | MS-7-142    | MS-7-142-Y  |
| 8                | MS-8-142    | MS-8-142-Y  |
| 9                | MS-9-142    | MS-9-142-Y  |
| 10               | MS-10-142   | MS-10-142-Y |
| 11               | MS-11-142   | MS-11-142-Y |
| 12               | MS-12-142   | MS-12-142-Y |
| 13               | MS-13-142   | MS-13-142-Y |
| 14               | MS-14-142   | MS-14-142-Y |
| 15               | MS-15-142   | MS-15-142-Y |
| 16               | MS-16-142   | MS-16-142-Y |
| 17               | MS-17-142   | MS-17-142-Y |

Use Standard Marker Strips for "3/4W" and "W" Solder Terminals.

## Accessories

- Jumpers
- Fanning Strips

Marketed exclusively through distribution.

# Barrier Blocks Series 150

.688 Density, 10-32 x 5/16"  
BH Screw, Open Bottom,  
Double Row



### Electrical Characteristics

**Voltage Rating:** 250 VAC RMS maximum  
**Current Rating:** 40 Amps maximum  
**Maximum Watts Per Terminal:** 10,000

### Mechanical Characteristics

**Maximum Wire Size:** #10 AWG  
**Recommended Tightening Torque:** 20 lb.-in.



### Dimensions



### Ordering Information

| No. of Terminals | Standard Screw Catalog No. | Y-Terminals Catalog No. | "M" Dim. | "L" Dim. |
|------------------|----------------------------|-------------------------|----------|----------|
| 1                | 1-150                      | 1-150-Y                 | 1.375    | 1.812    |
| 2                | 2-150                      | 2-150-Y                 | 2.062    | 2.500    |
| 3                | 3-150                      | 3-150-Y                 | 2.750    | 3.187    |
| 4                | 4-150                      | 4-150-Y                 | 3.437    | 3.875    |
| 5                | 5-150                      | 5-150-Y                 | 4.125    | 4.562    |
| 6                | 6-150                      | 6-150-Y                 | 4.812    | 5.250    |
| 7                | 7-150                      | 7-150-Y                 | 5.500    | 5.938    |
| 8                | 8-150                      | 8-150-Y                 | 6.187    | 6.625    |
| 9                | 9-150                      | 9-150-Y                 | 6.875    | 7.312    |
| 10               | 10-150                     | 10-150-Y                | 7.562    | 8.000    |

Marketed exclusively through distribution.

# Barrier Blocks Series 150

.688 Density, 10-32 x 5/16"  
BH Screw, Open Bottom,  
Double Row



## Marker Strips

## Dimensions



## Ordering Information

| No. of Terminals | Catalog No. | Catalog No. |
|------------------|-------------|-------------|
| 1                | MS-1-150    | MS-1-150-Y  |
| 2                | MS-2-150    | MS-2-150-Y  |
| 3                | MS-3-150    | MS-3-150-Y  |
| 4                | MS-4-150    | MS-4-150-Y  |
| 5                | MS-5-150    | MS-5-150-Y  |
| 6                | MS-6-150    | MS-6-150-Y  |
| 7                | MS-7-150    | MS-7-150-Y  |
| 8                | MS-8-150    | MS-8-150-Y  |
| 9                | MS-9-150    | MS-9-150-Y  |
| 10               | MS-10-150   | MS-10-150-Y |

## Accessories

None Available for 150 Series.

Marketed exclusively through distribution.

# Barrier Blocks Series 151

.875 Density, 12-32 x 3/8"  
BH Screw, Open Bottom,  
Double Row



## Electrical Characteristics

**Voltage Rating:** 250 Volts maximum  
**Current Rating:** 50 Amps maximum  
**Maximum Watts Per Terminal:** 12,500

## Mechanical Characteristics

**Maximum Wire Size:** #8  
**Recommended Tightening Torque:** 40 lb.-in.



## Dimensions



## Ordering Information

| No. of Terminals | Catalog No. | "M"<br>Dim. (in) | "L"<br>Dim. (in) | Marker Strip<br>Catalog No. |
|------------------|-------------|------------------|------------------|-----------------------------|
| 1                | 1-151       | 1.750            | 2.282            | N/A                         |
| 2                | 2-151       | 2.625            | 3.157            | MS-2-151                    |
| 3                | 3-151       | 3.500            | 4.032            | MS-3-151                    |
| 4                | 4-151       | 4.375            | 4.907            | MS-4-151                    |
| 5                | 5-151       | 5.250            | 5.782            | MS-5-151                    |
| 6                | 6-151       | 6.125            | 6.657            | MS-6-151                    |
| 7                | 7-151       | 7.000            | 7.532            | MS-7-151                    |
| 8                | 8-151       | 7.875            | 8.407            | MS-8-151                    |

Solder Terminals can be ordered separately.

**Terminal Type** "W"  
**Catalog No.** W-151

Marketed exclusively through distribution.

# Barrier Blocks Series 152

1.25 Density, 1/4-28 x 1/2"  
BH Screw, Open Bottom,  
Double Row



## Electrical Characteristics

**Voltage Rating:** 250 Volts maximum  
**Current Rating:** 70 Amps maximum  
**Maximum Watts Per Terminal:** 54,000

## Mechanical Characteristics

**Maximum Wire Size:** #6  
**Recommended Tightening Torque:** 75 lb.-in.



## Dimensions



## Ordering Information

| No. of Terminals | Catalog No. | "M" Dim. (in) | "L" Dim. (in) | Marker Strip Catalog No. |
|------------------|-------------|---------------|---------------|--------------------------|
| 1                | 1-152       | 2.250         | 2.876         | N/A                      |
| 2                | 2-152       | 3.375         | 4.001         | MS-2-152                 |
| 3                | 3-152       | 4.500         | 5.126         | MS-3-152                 |
| 4                | 4-152       | 5.625         | 6.251         | MS-4-152                 |
| 5                | 5-152       | 6.750         | 7.376         | MS-5-152                 |
| 6                | 6-152       | 7.875         | 8.501         | MS-6-152                 |

## Accessories

None Available for 152 Series.

Marketed exclusively through distribution.

# Barrier Blocks Series 164

.375 Density, 6-32 x 5/16"  
BH Screw, Open Bottom,  
Double Row



## Electrical Characteristics

**Voltage Rating:** 250 Volts maximum  
**Current Rating:** 15 Amps maximum  
**Maximum Watts Per Terminal:** 3750

## Mechanical Characteristics

**Maximum Wire Size:** #14  
**Recommended Tightening Torque:** 12 lb.-in.

## Dimensions

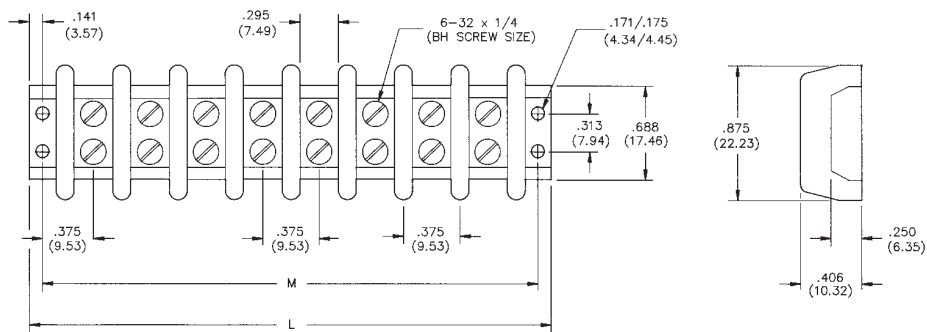
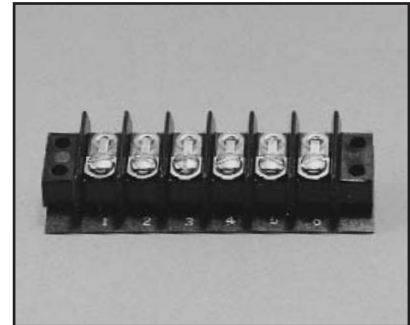

## Ordering Information

| No. of Terminals | Catalog No. | "M"<br>Dim. (in) | "L"<br>Dim. (in) |
|------------------|-------------|------------------|------------------|
| 1                | 1-164       | 0.750            | 1.032            |
| 2                | 2-164       | 1.125            | 1.407            |
| 3                | 3-164       | 1.500            | 1.782            |
| 4                | 4-164       | 1.875            | 2.157            |
| 5                | 5-164       | 2.250            | 2.532            |
| 6                | 6-164       | 2.625            | 2.907            |
| 7                | 7-164       | 3.000            | 3.282            |
| 8                | 8-164       | 3.375            | 3.657            |
| 9                | 9-164       | 3.750            | 4.032            |
| 10               | 10-164      | 4.125            | 4.407            |
| 11               | 11-164      | 4.500            | 4.782            |
| 12               | 12-164      | 4.875            | 5.157            |
| 13               | 13-164      | 5.250            | 5.532            |
| 14               | 14-164      | 5.625            | 5.907            |
| 15               | 15-164      | 6.000            | 6.282            |
| 16               | 16-164      | 6.375            | 6.657            |
| 17               | 17-164      | 6.750            | 7.032            |
| 18               | 18-164      | 7.125            | 7.407            |
| 19               | 19-164      | 7.500            | 7.782            |
| 20               | 20-164      | 7.875            | 8.157            |
| 21               | 21-164      | 8.250            | 8.532            |

Marketed exclusively through distribution.



# Barrier Blocks Series 164

.375 Density, 6-32 x 1/4"  
BH Screw, Open Bottom,  
Double Row



## Solder Terminal Options

### Dimensions

“Y” Terminals



“3/4W” Terminals



“W” Terminals

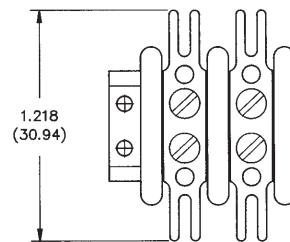

## Ordering Information

| No. of Terminals | Catalog No. | Catalog No. | Catalog No. |
|------------------|-------------|-------------|-------------|
| 1                | 1-164-Y     | 1-164-3/4W  | 1-164-W     |
| 2                | 2-164-Y     | 2-164-3/4W  | 2-164-W     |
| 3                | 3-164-Y     | 3-164-3/4W  | 3-164-W     |
| 4                | 4-164-Y     | 4-164-3/4W  | 4-164-W     |
| 5                | 5-164-Y     | 5-164-3/4W  | 5-164-W     |
| 6                | 6-164-Y     | 6-164-3/4W  | 6-164-W     |
| 7                | 7-164-Y     | 7-164-3/4W  | 7-164-W     |
| 8                | 8-164-Y     | 8-164-3/4W  | 8-164-W     |
| 9                | 9-164-Y     | 9-164-3/4W  | 9-164-W     |
| 10               | 10-164-Y    | 10-164-3/4W | 10-164-W    |
| 11               | 11-164-Y    | 11-164-3/4W | 11-164-W    |
| 12               | 12-164-Y    | 12-164-3/4W | 12-164-W    |
| 13               | 13-164-Y    | 13-164-3/4W | 13-164-W    |
| 14               | 14-164-Y    | 14-164-3/4W | 14-164-W    |
| 15               | 15-164-Y    | 15-164-3/4W | 15-164-W    |
| 16               | 16-164-Y    | 16-164-3/4W | 16-164-W    |
| 17               | 17-164-Y    | 17-164-3/4W | 17-164-W    |
| 18               | 18-164-Y    | 18-164-3/4W | 18-164-W    |
| 19               | 19-164-Y    | 19-164-3/4W | 19-164-W    |
| 20               | 20-164-Y    | 20-164-3/4W | 20-164-W    |
| 21               | 21-164-Y    | 21-164-3/4W | 21-164-W    |

Marketed exclusively through distribution.

# Barrier Blocks Series 164

.375 Density, 6-32 x 1/4"  
BH Screw, Open Bottom,  
Double Row



## Marker Strips

### Dimensions



## Ordering Information

| No. of Terminals | Catalog No. | Catalog No. |
|------------------|-------------|-------------|
| 1                | N/A         | N/A         |
| 2                | MS-2-140    | MS-2-140-Y  |
| 3                | MS-3-140    | MS-3-140-Y  |
| 4                | MS-4-140    | MS-4-140-Y  |
| 5                | MS-5-140    | MS-5-140-Y  |
| 6                | MS-6-140    | MS-6-140-Y  |
| 7                | MS-7-140    | MS-7-140-Y  |
| 8                | MS-8-140    | MS-8-140-Y  |
| 9                | MS-9-140    | MS-9-140-Y  |
| 10               | MS-10-140   | MS-10-140-Y |
| 11               | MS-11-140   | MS-11-140-Y |
| 12               | MS-12-140   | MS-12-140-Y |
| 13               | MS-13-140   | MS-13-140-Y |
| 14               | MS-14-140   | MS-14-140-Y |
| 15               | MS-15-140   | MS-15-140-Y |
| 16               | MS-16-140   | MS-16-140-Y |
| 17               | MS-17-140   | MS-17-140-Y |
| 18               | MS-18-140   | MS-18-140-Y |
| 19               | MS-19-140   | MS-19-140-Y |
| 20               | MS-20-140   | MS-20-140-Y |
| 21               | MS-21-140   | MS-21-140-Y |

Use Standard Marker Strips for "3/4W" and "W" Solder Terminals.

Marketed exclusively through distribution.

# Barrier Blocks Series 540

.375 Density, 5-40 x 1/4"  
BH Screw, Closed Bottom,  
Double Row



## Electrical Characteristics

**Voltage Rating:** 600 Volts maximum  
**Current Rating:** 15 Amps  
**Maximum Watts Per Terminal:** 3750

## Mechanical Characteristics

**Maximum Wire Size:** #16  
**Recommended Tightening Torque:** 9 lb.-in.

## Dimensions



## Ordering Information

| No. of Terminals | Catalog No. | "M"<br>Dim. (in) | "L"<br>Dim. (in) | Marker Strip<br>Catalog No. |
|------------------|-------------|------------------|------------------|-----------------------------|
| 2                | 2-540       | 1.125            | 1.407            | MSX-2-540                   |
| 3                | 3-540       | 1.500            | 1.782            | MSX-3-540                   |
| 4                | 4-540       | 1.875            | 2.157            | MSX-4-540                   |
| 5                | 5-540       | 2.250            | 2.532            | MSX-5-540                   |
| 6                | 6-540       | 2.625            | 2.907            | MSX-6-540                   |
| 7                | 7-540       | 3.000            | 3.282            | MSX-7-540                   |
| 8                | 8-540       | 3.375            | 3.657            | MSX-8-540                   |
| 9                | 9-540       | 3.750            | 4.032            | MSX-9-540                   |
| 10               | 10-540      | 4.125            | 4.407            | MSX-10-540                  |
| 11               | 11-540      | 4.500            | 4.782            | MSX-11-540                  |
| 12               | 12-540      | 4.875            | 5.157            | MSX-12-540                  |
| 13               | 13-540      | 5.250            | 5.532            | MSX-13-540                  |
| 14               | 14-540      | 5.625            | 5.907            | MSX-14-540                  |
| 15               | 15-540      | 6.000            | 6.282            | MSX-15-540                  |
| 16               | 16-540      | 6.375            | 6.657            | MSX-16-540                  |
| 17               | 17-540      | 6.750            | 7.032            | MSX-17-540                  |
| 18               | 18-540      | 7.125            | 7.407            | MSX-18-540                  |
| 19               | 19-540      | 7.500            | 7.782            | MSX-19-540                  |
| 20               | 20-540      | 7.875            | 8.157            | MSX-20-540                  |
| 21               | 21-540      | 8.250            | 8.532            | MSX-21-540                  |
| 22               | 22-540      | 8.625            | 8.907            | MSX-22-540                  |
| 23               | 23-540      | 9.000            | 9.282            | MSX-23-540                  |
| 24               | 24-540      | 9.375            | 9.657            | MSX-24-540                  |
| 25               | 25-540      | 9.750            | 10.032           | MSX-25-540                  |
| 26               | 26-540      | 10.125           | 10.407           | MSX-26-540                  |
| 27               | 27-540      | 10.500           | 10.782           | MSX-27-540                  |
| 28               | 28-540      | 10.875           | 11.157           | MSX-28-540                  |
| 29               | 29-540      | 11.250           | 11.532           | MSX-29-540                  |
| 30               | 30-540      | 11.625           | 11.907           | MSX-30-540                  |
| 31               | 31-540      | 12.000           | 12.282           | MSX-31-540                  |

Marketed exclusively through distribution.

# Barrier Blocks Series 541

.438 Density, 6-32 x 1/4"  
BH Screw, Closed Bottom,  
Double Row



## Electrical Characteristics

**Voltage Rating:** 600 Volts maximum  
**Current Rating:** 20 Amps  
**Maximum Watts Per Terminal:** 5000

## Mechanical Characteristics

**Maximum Wire Size:** #14  
**Recommended Tightening Torque:** 12 lb.-in.

## Dimensions



## Ordering Information

| No. of Terminals | Catalog No. | "M" Dim. (in) | "L" Dim. (in) | Marker Strip Catalog No. |
|------------------|-------------|---------------|---------------|--------------------------|
| 2                | 2-541       | 1.314         | 1.626         | MSX-2-541                |
| 3                | 3-541       | 1.752         | 2.064         | MSX-3-541                |
| 4                | 4-541       | 2.190         | 2.502         | MSX-4-541                |
| 5                | 5-541       | 2.628         | 2.940         | MSX-5-541                |
| 6                | 6-541       | 3.066         | 3.378         | MSX-6-541                |
| 7                | 7-541       | 3.504         | 3.816         | MSX-7-541                |
| 8                | 8-541       | 3.942         | 4.254         | MSX-8-541                |
| 9                | 9-541       | 4.380         | 4.692         | MSX-9-541                |
| 10               | 10-541      | 4.818         | 5.130         | MSX-10-541               |
| 11               | 11-541      | 5.256         | 5.568         | MSX-11-541               |
| 12               | 12-541      | 5.694         | 6.006         | MSX-12-541               |
| 13               | 13-541      | 6.132         | 6.444         | MSX-13-541               |
| 14               | 14-541      | 6.570         | 6.882         | MSX-14-541               |
| 15               | 15-541      | 7.008         | 7.320         | MSX-15-541               |
| 16               | 16-541      | 7.446         | 7.758         | MSX-16-541               |
| 17               | 17-541      | 7.884         | 8.196         | MSX-17-541               |
| 18               | 18-541      | 8.322         | 8.634         | MSX-18-541               |
| 19               | 19-541      | 8.760         | 9.072         | MSX-19-541               |
| 20               | 20-541      | 9.198         | 9.510         | MSX-20-541               |
| 21               | 21-541      | 9.636         | 9.948         | MSX-21-541               |
| 22               | 22-541      | 10.074        | 10.386        | MSX-22-541               |
| 23               | 23-541      | 10.512        | 10.824        | MSX-23-541               |
| 24               | 24-541      | 10.950        | 11.262        | MSX-24-541               |
| 25               | 25-541      | 11.388        | 11.700        | MSX-25-541               |
| 26               | 26-541      | 11.826        | 12.138        | MSX-26-541               |
| 27               | 27-541      | 12.264        | 12.576        | MSX-27-541               |
| 28               | 28-541      | 12.702        | 13.014        | MSX-28-541               |
| 29               | 29-541      | 13.140        | 13.452        | MSX-29-541               |
| 30               | 30-541      | 13.578        | 13.890        | MSX-30-541               |

Marketed exclusively through distribution.

# Barrier Blocks Series 542

.563 Density, 8-32 x 5/16"  
BH Screw, Closed Bottom,  
Double Row



## Electrical Characteristics

Voltage Rating: 600 Volts maximum  
Current Rating: 30 Amps  
Maximum Watts Per Terminal: 7500

## Mechanical Characteristics

Maximum Wire Size: #10  
Recommended Tightening Torque: 16 lb.-in.

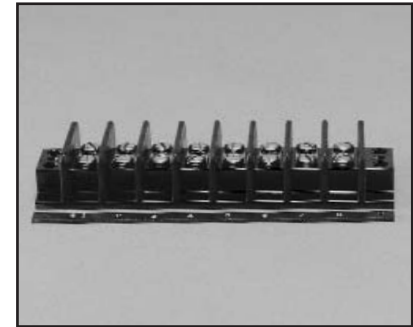

## Dimensions

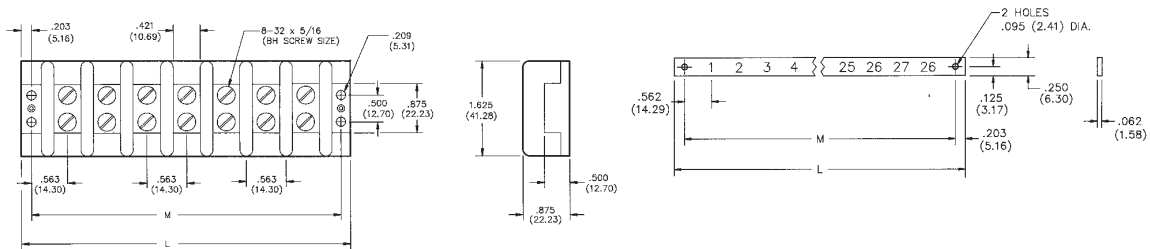

## Ordering Information

| No. of Terminals | Catalog No. | "M"<br>Dim. (in) | "L"<br>Dim. (in) | Marker Strip<br>Catalog No. |
|------------------|-------------|------------------|------------------|-----------------------------|
| 2                | 2-542       | 1.689            | 2.095            | MSX-2-542                   |
| 3                | 3-542       | 2.252            | 2.658            | MSX-3-542                   |
| 4                | 4-542       | 2.815            | 3.221            | MSX-4-542                   |
| 5                | 5-542       | 3.378            | 3.784            | MSX-5-542                   |
| 6                | 6-542       | 3.941            | 4.347            | MSX-6-542                   |
| 7                | 7-542       | 4.504            | 4.910            | MSX-7-542                   |
| 8                | 8-542       | 5.067            | 5.473            | MSX-8-542                   |
| 9                | 9-542       | 5.630            | 6.036            | MSX-9-542                   |
| 10               | 10-542      | 6.193            | 6.599            | MSX-10-542                  |
| 11               | 11-542      | 6.756            | 7.162            | MSX-11-542                  |
| 12               | 12-542      | 7.319            | 7.725            | MSX-12-542                  |
| 13               | 13-542      | 7.882            | 8.288            | MSX-13-542                  |
| 14               | 14-542      | 8.445            | 8.851            | MSX-14-542                  |
| 15               | 15-542      | 9.008            | 9.414            | MSX-15-542                  |
| 16               | 16-542      | 9.571            | 9.977            | MSX-16-542                  |
| 17               | 17-542      | 10.134           | 10.540           | MSX-17-542                  |
| 18               | 18-542      | 10.697           | 11.103           | MSX-18-542                  |
| 19               | 19-542      | 11.260           | 11.666           | MSX-19-542                  |
| 20               | 20-542      | 11.823           | 12.229           | MSX-20-542                  |
| 21               | 21-542      | 12.386           | 12.792           | MSX-21-542                  |
| 22               | 22-542      | 12.949           | 13.355           | MSX-22-542                  |
| 23               | 23-542      | 13.512           | 13.918           | MSX-23-542                  |
| 24               | 24-542      | 14.075           | 14.481           | MSX-24-542                  |
| 25               | 25-542      | 14.638           | 15.044           | MSX-25-542                  |
| 26               | 26-542      | 15.201           | 15.607           | MSX-26-542                  |

Marketed exclusively through distribution.

# Barrier Blocks Series 176

.375 Density, 5-40 x 3/16"  
BH Screw, Dip Solder,  
Single Row



## Electrical Characteristics

**Voltage Rating:** 250 Volts maximum  
**Current Rating:** 15 Amps maximum  
**Maximum Watts Per Terminal:** 3750

## Mechanical Characteristics

**Maximum Wire Size:** 16 AWG  
**Recommended Tightening Torque:** 16 lb.-in.



## Dimensions



## Ordering Information

| No. of Terminals | With Mounting Ears         |                            | "M" Dimension | "L" Dimension |
|------------------|----------------------------|----------------------------|---------------|---------------|
|                  | Catalog No. .125 Tail Lgth | Catalog No. .184 Tail Lgth |               |               |
| 2                | 2-176-2                    | 2-176-3                    | 1.125         | 1.469         |
| 3                | 3-176-2                    | 3-176-3                    | 1.500         | 1.844         |
| 4                | 4-176-2                    | 4-176-3                    | 1.875         | 2.219         |
| 5                | 5-176-2                    | 5-176-3                    | 2.250         | 2.594         |
| 6                | 6-176-2                    | 6-176-3                    | 2.625         | 2.969         |
| 7                | 7-176-2                    | 7-176-3                    | 3.000         | 3.344         |
| 8                | 8-176-2                    | 8-176-3                    | 3.375         | 3.719         |
| 9                | 9-176-2                    | 9-176-3                    | 3.375         | 4.094         |
| 10               | 10-176-2                   | 10-176-3                   | 4.125         | 4.469         |

| No. of Terminals | Without Mounting Ears      |                            | "L" Dimension |
|------------------|----------------------------|----------------------------|---------------|
|                  | Catalog No. .125 Tail Lgth | Catalog No. .184 Tail Lgth |               |
| 2                | 2-176-2A                   | 2-176-3A                   | .719          |
| 3                | 3-176-2A                   | 3-176-3A                   | 1.094         |
| 4                | 4-176-2A                   | 4-176-3A                   | 1.469         |
| 5                | 5-176-2A                   | 5-176-3A                   | 1.844         |
| 6                | 6-176-2A                   | 6-176-3A                   | 2.219         |
| 7                | 7-176-2A                   | 7-176-3A                   | 2.594         |
| 8                | 8-176-2A                   | 8-176-3A                   | 2.969         |
| 9                | 9-176-2A                   | 9-176-3A                   | 3.344         |
| 10               | 10-176-2A                  | 10-176-3A                  | 3.719         |
| 11               | 11-176-2A                  | 11-176-3A                  | 4.094         |
| 12               | 12-176-2A                  | 12-176-3A                  | 4.469         |

Marketed exclusively through distribution.

## Solder Terminals 3/4W, Y, and W

Optional Terminals for use with Cinch terminal blocks.  
See chart for type and dimensions. (Below)

2



### Ordering Information

#### "3/4 W" Terminals - Dimensions

| Catalog Number | A     |       | B    |       | C    |       | D    |      | E    |      | F    |      |
|----------------|-------|-------|------|-------|------|-------|------|------|------|------|------|------|
|                | in    | mm    | in   | mm    | in   | mm    | in   | mm   | in   | mm   | in   | mm   |
| 3/4W-140       | .953  | 24.21 | .719 | 18.20 | .312 | 7.92  | .062 | 1.57 | .146 | 3.71 | .094 | 2.39 |
| 3/4W-141       | 1.156 | 29.36 | .680 | 17.27 | .422 | 10.72 | .078 | 1.98 | .152 | 3.86 | .125 | 3.18 |
| 3/4W-142       | 1.422 | 36.11 | .797 | 20.24 | .500 | 12.70 | .094 | 2.39 | .177 | 4.50 | .125 | 3.18 |

#### "Y" Terminals - Dimensions

| Catalog Number | A    |       | B    |       | C    |      | D    |       | E    |      | F    |      |
|----------------|------|-------|------|-------|------|------|------|-------|------|------|------|------|
|                | in   | mm    | in   | mm    | in   | mm   | in   | mm    | in   | mm   | in   | mm   |
| Y-140          | .281 | 7.14  | .500 | 12.70 | .136 | 3.45 | .593 | 15.06 | .093 | 2.36 | .091 | 2.31 |
| Y-141          | .312 | 7.92  | .625 | 15.88 | .152 | 3.86 | .781 | 19.83 | .125 | 3.18 | .103 | 2.62 |
| Y-142          | .421 | 10.69 | .734 | 18.64 | .177 | 4.50 | .906 | 23.01 | .125 | 3.18 | .126 | 3.20 |

#### "W" Terminals - Dimensions

| Catalog Number | A     |       | B     |       | C    |       | D    |      | E    |      | F    |      |
|----------------|-------|-------|-------|-------|------|-------|------|------|------|------|------|------|
|                | in    | mm    | in    | mm    | in   | mm    | in   | mm   | in   | mm   | in   | mm   |
| W-140          | 1.219 | 30.96 | .750  | 19.05 | .312 | 7.92  | .063 | 1.60 | .146 | 3.71 | .094 | 2.39 |
| W-141          | 1.563 | 39.70 | .938  | 23.83 | .422 | 10.72 | .078 | 1.98 | .152 | 3.86 | .125 | 3.18 |
| W-142          | 1.875 | 47.63 | 1.094 | 27.79 | .500 | 12.70 | .094 | 2.39 | .177 | 4.50 | .125 | 3.18 |

Marketed exclusively through distribution.

# Barrier Blocks Accessories



## Quick Clamp Terminals

Simplifies engaging of wires to barrier blocks. Wire is inserted into flared opening and screw is tightened. Screws are brass binder head type with nickel plating. Terminals are brass with tin plating. Includes two mating clamps and one screw.



QC-1  
Shown

## Ordering Information

| Barrier Block Series | Catalog No. | Screw Size | Wire Gauge Range AWG |
|----------------------|-------------|------------|----------------------|
| 141, 541             | QC-1        | 6-32x5/16" | 12 thru 22           |
| 142, 542             | QC-2        | 8-32x3/8"  | 10 thru 16           |

## Jumpers

For connecting between adjacent terminals or alternate terminals. All jumpers are brass with nickel plating.

## Ordering Information

| Barrier Block Series | Type | Catalog No. |
|----------------------|------|-------------|
| 140                  | A    | 140J-1      |
| 141                  | B    | 141J-1      |
| 141                  | F    | 141J        |
| 142                  | F    | 95B         |
| 142, 542             | D    | 142J-1*     |
| 142, 542             | E    | 142J-2      |
| 540                  | C    | 540J        |
| 541                  | C    | 541J        |
| 542                  | C    | 542J        |

\* Connects two alternate terminals



Type A



Type B



Type C



Type D



Type E



Type F

Marketed exclusively through distribution.



FEATURES

- *Minimize wiring errors.*
- *Available in straight and right-angle styles.*
- *Available with cable clamp hole on right or left side, designated by "L" or "R" at end of catalog number.*
- *Cable clamp hole for securing cable/wires with lacing twine or ty-wrap.*

MATERIALS

**Insulation Material:** UL 94HB rated XPC, chocolate

**Contact Material:** Brass

**Contact Plating:** Cadmium



Marketed exclusively through distribution.

**Catalog Numbers and Dimensions for Fanning Strips for 140 Series Terminal Blocks**

**Straight Type**

**Dimensions**



Catalog No. 6-160-R



Catalog No. 6-160B-R

**Ordering Information**

| No. of Terminals | Catalog No. | Catalog No. | Catalog No. | Catalog No. |
|------------------|-------------|-------------|-------------|-------------|
| 2                | 2-160-R     | 2-160-L     | 2-160B-R    | 2-160B-L    |
| 3                | 3-160-R     | 3-160-L     | 3-160B-R    | 3-160B-L    |
| 4                | 4-160-R     | 4-160-L     | 4-160B-R    | 4-160B-L    |
| 5                | 5-160-R     | 5-160-L     | 5-160B-R    | 5-160B-L    |
| 6                | 6-160-R     | 6-160-L     | 6-160B-R    | 6-160B-L    |
| 7                | 7-160-R     | 7-160-L     | 7-160B-R    | 7-160B-L    |
| 8                | 8-160-R     | 8-160-L     | 8-160B-R    | 8-160B-L    |
| 9                | 9-160-R     | 9-160-L     | 9-160B-R    | 9-160B-L    |
| 10               | 10-160-R    | 10-160-L    | 10-160B-R   | 10-160B-L   |
| 11               | 11-160-R    | 11-160-L    | 11-160B-R   | 11-160B-L   |
| 12               | 12-160-R    | 12-160-L    | 12-160B-R   | 12-160B-L   |
| 13               | 13-160-R    | 13-160-L    | 13-160B-R   | 13-160B-L   |
| 14               | 14-160-R    | 14-160-L    | 14-160B-R   | 14-160B-L   |
| 15               | 15-160-R    | 15-160-L    | 15-160B-R   | 15-160B-L   |
| 16               | 16-160-R    | 16-160-L    | 16-160B-R   | 16-160B-L   |
| 17               | 17-160-R    | 17-160-L    | 17-160B-R   | 17-160B-L   |
| 18               | 18-160-R    | 18-160-L    | 18-160B-R   | 18-160B-L   |
| 19               | 19-160-R    | 19-160-L    | 19-160B-R   | 19-160B-L   |
| 20               | 20-160-R    | 20-160-L    | 20-160B-R   | 20-160B-L   |
| 21               | 21-160-R    | 21-160-L    | 21-160B-R   | 21-160B-L   |

Marketed exclusively through distribution.

Catalog Numbers and Dimensions for Fanning Strips for 140 Series Terminal Blocks, Continued

Right-Angle Type

Dimensions



Catalog No. 6-160A-R

Ordering Information

| No. of Terminals | Catalog No. | Catalog No. |
|------------------|-------------|-------------|
| 2                | 2-160A-R    | 2-160A-L    |
| 3                | 3-160A-R    | 3-160A-L    |
| 4                | 4-160A-R    | 4-160A-L    |
| 5                | 5-160A-R    | 5-160A-L    |
| 6                | 6-160A-R    | 6-160A-L    |
| 7                | 7-160A-R    | 7-160A-L    |
| 8                | 8-160A-R    | 8-160A-L    |
| 9                | 9-160A-R    | 9-160A-L    |
| 10               | 10-160A-R   | 10-160A-L   |
| 11               | 11-160A-R   | 11-160A-L   |
| 12               | 12-160A-R   | 12-160A-L   |
| 13               | 13-160A-R   | 13-160A-L   |
| 14               | 14-160A-R   | 14-160A-L   |
| 15               | 15-160A-R   | 15-160A-L   |
| 16               | 16-160A-R   | 16-160A-L   |
| 17               | 17-160A-R   | 17-160A-L   |
| 18               | 18-160A-R   | 18-160A-L   |
| 19               | 19-160A-R   | 19-160A-L   |
| 20               | 20-160A-R   | 20-160A-L   |
| 21               | 21-160A-R   | 21-160A-L   |

Marketed exclusively through distribution.

**Catalog Numbers and Dimensions for Fanning Strips for 141 Series Terminal Blocks**

**Straight Type**

| No. of Terminals | Catalog No. | Catalog No. |
|------------------|-------------|-------------|
| 2                | 2-161-R     | 2-161-L     |
| 3                | 3-161-R     | 3-161-L     |
| 4                | 4-161-R     | 4-161-L     |
| 5                | 5-161-R     | 5-161-L     |
| 6                | 6-161-R     | 6-161-L     |
| 7                | 7-161-R     | 7-161-L     |
| 8                | 8-161-R     | 8-161-L     |
| 9                | 9-161-R     | 9-161-L     |
| 10               | 10-161-R    | 10-161-L    |
| 11               | 11-161-R    | 11-161-L    |
| 12               | 12-161-R    | 12-161-L    |
| 13               | 13-161-R    | 13-161-L    |
| 14               | 14-161-R    | 14-161-L    |
| 15               | 15-161-R    | 15-161-L    |
| 16               | 16-161-R    | 16-161-L    |
| 17               | 17-161-R    | 17-161-L    |
| 18               | 18-161-R    | 18-161-L    |
| 19               | 19-161-R    | 19-161-L    |
| 20               | 20-161-R    | 20-161-L    |

**Dimensions**



Catalog No. 5-161-R

**Right-Angle Type**

| No. of Terminals | Catalog No. | Catalog No. |
|------------------|-------------|-------------|
| 2                | 2-161A-R    | 2-161A-L    |
| 3                | 3-161A-R    | 3-161A-L    |
| 4                | 4-161A-R    | 4-161A-L    |
| 5                | 5-161A-R    | 5-161A-L    |
| 6                | 6-161A-R    | 6-161A-L    |
| 7                | 7-161A-R    | 7-161A-L    |
| 8                | 8-161A-R    | 8-161A-L    |
| 9                | 9-161A-R    | 9-161A-L    |
| 10               | 10-161A-R   | 10-161A-L   |
| 11               | 11-161A-R   | 11-161A-L   |
| 12               | 12-161A-R   | 12-161A-L   |
| 13               | 13-161A-R   | 13-161A-L   |
| 14               | 14-161A-R   | 14-161A-L   |
| 15               | 15-161A-R   | 15-161A-L   |
| 16               | 16-161A-R   | 16-161A-L   |
| 17               | 17-161A-R   | 17-161A-L   |
| 18               | 18-161A-R   | 18-161A-L   |
| 19               | 19-161A-R   | 19-161A-L   |
| 20               | 20-161A-R   | 20-161A-L   |

**Dimensions**



Catalog No. 5-161A-R

Marketed exclusively through distribution.

**Catalog Numbers and Dimensions for Fanning Strips for 142 Series Barrier Blocks**

**Straight Type**

**Ordering Information**

| No. of Terminals | Catalog No. | Catalog No. |
|------------------|-------------|-------------|
| 2                | 2-162-R     | 2-162-L     |
| 3                | 3-162-R     | 3-162-L     |
| 4                | 4-162-R     | 4-162-L     |
| 5                | 5-162-R     | 5-162-L     |
| 6                | 6-162-R     | 6-162-L     |
| 7                | 7-162-R     | 7-162-L     |
| 8                | 8-162-R     | 8-162-L     |
| 9                | 9-162-R     | 9-162-L     |
| 10               | 10-162-R    | 10-162-L    |
| 11               | 11-162-R    | 11-162-L    |
| 12               | 12-162-R    | 12-162-L    |
| 13               | 13-162-R    | 13-162-L    |
| 14               | 14-162-R    | 14-162-L    |
| 15               | 15-162-R    | 15-162-L    |
| 16               | 16-162-R    | 16-162-L    |
| 17               | 17-162-R    | 17-162-L    |

**Dimensions**



Catalog No. 5-162-R

**Right-Angle Type**

**Ordering Information**

| No. of Terminals | Catalog No. | Catalog No. |
|------------------|-------------|-------------|
| 2                | 2-162A-R    | 2-162A-L    |
| 3                | 3-162A-R    | 3-162A-L    |
| 4                | 4-162A-R    | 4-162A-L    |
| 5                | 5-162A-R    | 5-162A-L    |
| 6                | 6-162A-R    | 6-162A-L    |
| 7                | 7-162A-R    | 7-162A-L    |
| 8                | 8-162A-R    | 8-162A-L    |
| 9                | 9-162A-R    | 9-162A-L    |
| 10               | 10-162A-R   | 10-162A-L   |
| 11               | 11-162A-R   | 11-162A-L   |
| 12               | 12-162A-R   | 12-162A-L   |
| 13               | 13-162A-R   | 13-162A-L   |
| 14               | 14-162A-R   | 14-162A-L   |
| 15               | 15-162A-R   | 15-162A-L   |
| 16               | 16-162A-R   | 16-162A-L   |
| 17               | 17-162A-R   | 17-162A-L   |

**Dimensions**



Catalog No. 5-162A-R

Marketed exclusively through distribution.

### Materials

**Insulation Material:** UL 94 HB rated XPC, chocolate

**Contact Material:** Steel

**Contact Plating:** Cadmium

### Mechanical Characteristics

**Mounting Hole:** .140" (3.56mm) diameter

**Strip Dimension:** .0625" (1.59mm) thick x .375" (9.53mm) wide

**Lug Density:** .375" (9.53mm)

### Ordering Information

| Catalog No. | Mounting Centers | Lug Type Used In Position |   |   |   |   |   |   |   |
|-------------|------------------|---------------------------|---|---|---|---|---|---|---|
|             |                  | 1                         | 2 | 3 | 4 | 5 | 6 | 7 | 8 |
| 51          | -                | 1                         | 2 |   |   |   |   |   |   |
| 51A         | -                | 1                         | 4 |   |   |   |   |   |   |
| 51B         | -                | 2                         | 1 |   |   |   |   |   |   |
| 51C         | -                | 4                         | 1 |   |   |   |   |   |   |
| 51F         | -                | 1/2                       |   |   |   |   |   |   |   |
| 51L         | -                | 3                         | 1 |   |   |   |   |   |   |
| 51R         | -                | 1                         | 3 |   |   |   |   |   |   |
| 52          | -                | 1                         | 2 | 1 |   |   |   |   |   |
| 52A         | -                | 1                         | 4 | 1 |   |   |   |   |   |
| 52B         | -                | 2                         | 1 | 1 |   |   |   |   |   |
| 52C         | -                | 4                         | 1 | 1 |   |   |   |   |   |
| 52R         | -                | 1                         | 1 | 3 |   |   |   |   |   |
| 53          | 1.500 (38.10)    | 2                         | 1 | 1 | 1 | 2 |   |   |   |
| 53A         | 1.500 (38.10)    | 4                         | 1 | 1 | 1 | 4 |   |   |   |
| 53B         | .750 (19.05)     | 1                         | 2 | 1 | 2 | 1 |   |   |   |
| 53C         | .750 (19.05)     | 1                         | 4 | 1 | 4 | 1 |   |   |   |
| 53E         | -                | 1                         | 2 | 1 | 1 |   |   |   |   |
| 53F         | -                | 1                         | 4 | 1 | 1 |   |   |   |   |
| 54          | 1.875 (47.63)    | 2                         | 1 | 1 | 1 | 1 | 2 |   |   |
| 54A         | 1.875 (47.63)    | 4                         | 1 | 1 | 1 | 1 | 4 |   |   |
| 54B         | -                | 1                         | 1 | 2 | 1 | 1 |   |   |   |
| 54C         | -                | 1                         | 1 | 4 | 1 | 1 |   |   |   |
| 55          | 2.250 (57.15)    | 2                         | 1 | 1 | 1 | 1 | 1 | 2 |   |
| 55A         | 2.250 (57.15)    | 4                         | 1 | 1 | 1 | 1 | 1 | 4 |   |
| 55B         | 1.500 (38.10)    | 1                         | 2 | 1 | 1 | 1 | 2 | 1 |   |
| 55C         | 1.500 (38.10)    | 1                         | 4 | 1 | 1 | 1 | 4 | 1 |   |
| 56          | 2.625 (66.68)    | 2                         | 1 | 1 | 1 | 1 | 1 | 1 | 2 |
| 56A         | 2.625 (66.68)    | 4                         | 1 | 1 | 1 | 1 | 1 | 1 | 4 |
| 56B         | 1.875 (47.63)    | 1                         | 2 | 1 | 1 | 1 | 1 | 2 | 1 |
| 56C         | 1.875 (47.63)    | 1                         | 4 | 1 | 1 | 1 | 1 | 4 | 1 |



### Dimensions



Marketed exclusively through distribution.

**Jones  
Plugs/Sockets  
Series 300**

Multiple Density  
Solder Eyelet



FEATURES

- Solder lug terminals with .093" x .062" (2.36mm x 1.57mm) wiring holes.
- Two-contact "Jones" connector is round, all others are rectangular.
- For use in cable-to-panel and cable-to-cable applications.
- Designed for light and medium duty.
- Plug prongs are .156" (3.96mm) wide and .047" (1.19mm) thick.
- Polarized to prevent wrong-way insertion.
- Plugs have projecting flat blades, sockets have recessed twin bellows.
- Cable clamps of zinc and clear irridite-plated steel used for strain relief.
- UL Recognized-file E170218 (UL 1977), E130965 (UL1863).
- CSA-LR31996.
- See Panel Cutout dimension on page (2-38).

MATERIALS

**Insulation Material:** Molded monoblock, general purpose phenolic, black UL94V-1  
**Contact Material:** Plug: Brass  
 Socket: Phosphor bronze  
**Contact Plating:** Cadmium  
**Operating Temperature:** Up to +105°C  
**Hood Material:** UL 94V-0 rated thermoplastic



ELECTRICAL

**Operating Voltage:** 250 VAC RMS maximum  
**Current Rating:** 10 Amps  
**Contact Resistance:** 16 Milliohms maximum

Marketed exclusively through distribution.

Polarizing Patterns - 300 Series



302



304



308



303



306



310



312



315-12



324,327,330



315,318,321



333



**Mounting Dimensions**

| Reference | A     |       | B     |       | C     |       | D     |       |
|-----------|-------|-------|-------|-------|-------|-------|-------|-------|
|           | in    | mm    | in    | mm    | in    | mm    | in    | mm    |
| 303       | .453  | 11.51 | 1.016 | 25.81 | .750  | 19.05 | -     | -     |
| 304       | .719  | 18.26 | .781  | 19.84 | 1.000 | 25.40 | -     | -     |
| 306       | .719  | 18.26 | 1.031 | 26.19 | 1.000 | 25.40 | -     | -     |
| 308       | .719  | 18.26 | 1.281 | 32.54 | 1.000 | 25.40 | -     | -     |
| 310       | .719  | 18.26 | 1.578 | 40.08 | 1.000 | 25.40 | -     | -     |
| 312       | .953  | 24.21 | 1.266 | 32.16 | 1.250 | 31.75 | -     | -     |
| 315-12    | .953  | 24.21 | 1.516 | 38.51 | 1.250 | 31.75 | -     | -     |
| 315       | 1.016 | 25.81 | 1.641 | 41.68 | 1.375 | 34.93 | -     | -     |
| 318       | 1.016 | 25.81 | 1.953 | 49.61 | 1.375 | 34.93 | .625  | 15.88 |
| 321       | 1.016 | 25.81 | 2.266 | 57.56 | 1.375 | 34.93 | .469  | 11.91 |
| 324       | 1.016 | 25.81 | 2.578 | 65.48 | 1.375 | 34.93 | .625  | 15.88 |
| 327       | 1.016 | 25.81 | 2.891 | 73.43 | 1.375 | 34.93 | .781  | 19.84 |
| 330       | 1.016 | 25.81 | 3.203 | 81.36 | 1.375 | 34.93 | .938  | 23.83 |
| 333       | 1.016 | 25.81 | 3.516 | 89.31 | 1.375 | 34.93 | 1.094 | 27.79 |

NOTE: For 300 Series 2 through 33 contact angle bracket connectors. All mounting holes are .156" (3.96mm) dia. Maximum chassis thickness is .063" (1.59mm) for bottom mounting. Mounting holes are located on center line unless otherwise shown.



Marketed exclusively through distribution.

| No. of Contacts | With Angle Bracket |                    | No. of Contacts | Less Angle Bracket |                    |
|-----------------|--------------------|--------------------|-----------------|--------------------|--------------------|
|                 | Catalog No. Plug   | Catalog No. Socket |                 | Catalog No. Plug   | Catalog No. Socket |
| 2               | P-302-AB           | S-302-AB           | 2               | P-302-LAB          | S-302-LAB          |
| 3               | P-303-AB           | S-303-AB           | 3               | P-303-LAB          | S-303-LAB          |
| 4               | P-304-AB           | S-304-AB           | 4               | P-304-LAB          | S-304-LAB          |
| 6               | P-306-AB           | S-306-AB           | 6               | P-306-LAB          | S-306-LAB          |
| 8               | N/A                | N/A                | 8               | N/A                | N/A                |
| 10              | P-310-AB           | N/A                | 10              | P-310-LAB          | N/A                |
| 12              | P-312-AB           | N/A                | 12              | P-312-LAB          | N/A                |
| 15*             | N/A                | S-315-12-AB        | 15              | N/A                | S-315-12-LAB       |
| 15              | P-315-AB           | S-315-AB           | 15              | P-315-LAB          | S-315-LAB          |
| 18              | P-318-AB           | S-318-AB           | 18              | P-318-LAB          | S-318-LAB          |
| 21              | P-321-AB           | S-321-AB           | 21              | P-321-LAB          | S-321-LAB          |
| 24              | P-324-AB           | S-324-AB           | 24              | P-324-LAB          | S-324-LAB          |
| 27              | P-327-AB           | S-327-AB           | 27              | P-327-LAB          | S-327-LAB          |
| 30              | P-330-AB           | S-330-AB           | 30              | P-330-LAB          | S-330-LAB          |
| 33              | P-333-AB           | S-333-AB           | 33              | P-333-LAB          | S-333-LAB          |

X = length of plug contacts. This dimension does not apply to sockets.  
Y = length of plug or socket tails.



| No. of Contacts | A     |       | B    |       | C     |       | D     |       |
|-----------------|-------|-------|------|-------|-------|-------|-------|-------|
|                 | in    | mm    | in   | mm    | in    | mm    | in    | mm    |
| 2               | .656  | 16.67 | -    | -     | .969  | 24.61 | 1.219 | 30.96 |
| 3               | 1.000 | 25.40 | .438 | 11.11 | .750  | 19.05 | 1.062 | 26.99 |
| 4               | .750  | 19.05 | .688 | 17.46 | 1.000 | 25.40 | 1.312 | 33.34 |
| 6               | 1.000 | 25.40 | .688 | 17.46 | 1.000 | 25.40 | 1.312 | 33.34 |
| 8               | --    | --    | --   | --    | --    | --    | --    | --    |
| 10              | 1.562 | 39.69 | .688 | 17.46 | 1.000 | 25.40 | 1.312 | 33.34 |
| 12              | 1.250 | 31.75 | .938 | 23.81 | 1.250 | 31.75 | 1.562 | 39.69 |
| 15*             | 1.500 | 38.10 | .938 | 23.81 | 1.250 | 31.75 | 1.562 | 39.69 |

\*Special 15 contact arrangement to allow 12-position mating.

| Reference | L     |       | M        |       | Polarizing Pin |
|-----------|-------|-------|----------|-------|----------------|
|           | in    | mm    | in       | mm    |                |
| 15        | 1.625 | 41.28 | See note | -     | NO             |
| 18        | 1.938 | 49.23 | 1.250    | 31.75 | NO             |
| 21        | 2.250 | 57.15 | .938     | 23.81 | NO             |
| 24        | 2.563 | 65.10 | 1.250    | 31.75 | 14             |
| 27        | 2.875 | 73.03 | 1.562    | 39.69 | 14             |
| 30        | 3.188 | 80.98 | 1.875    | 47.63 | 14             |
| 33        | 3.500 | 88.90 | 2.188    | 55.58 | 17             |

NOTE: 15-position plug and socket require only two mounting brackets, mounted on center of connector.

Marketed exclusively through distribution.

**300 Series with Flush Plate (FP)**

| No. of Contacts | Catalog No. Plug | Catalog No. Socket |
|-----------------|------------------|--------------------|
| 2               | P-302-FP         | S-302-FP           |
| 3               | P-303-FP         | S-303-FP           |
| 4               | P-304-FP         | S-304-FP           |
| 6               | P-306-FP         | S-306-FP           |
| 8               | N/A              | N/A                |
| 10              | P-310-FP         | N/A                |
| 12              | P-312-FP         | N/A                |

NOTE: Not available in contact sizes 15-33.



X = length of plug contacts. This dimension does not apply to sockets.  
Y = length of plug or socket tails.



**Dimensions - Plug or Socket**

| No. of Contacts | A     |       | B     |       | C     |       | D     |       | E Max. |       |
|-----------------|-------|-------|-------|-------|-------|-------|-------|-------|--------|-------|
|                 | in    | mm    | in    | mm    | in    | mm    | in    | mm    | in     | mm    |
| 2               | 2.063 | 52.40 | 1.250 | 31.75 | 1.750 | 44.45 | -     | -     | .719   | 18.26 |
| 3               | 2.063 | 52.40 | 1.250 | 31.75 | 1.750 | 44.45 | .938  | 23.81 | .500   | 12.70 |
| 4               | 2.063 | 52.40 | 1.250 | 31.75 | 1.750 | 44.45 | .688  | 17.46 | .750   | 19.05 |
| 6               | 2.063 | 52.40 | 1.250 | 31.75 | 1.750 | 44.45 | .938  | 23.81 | .750   | 19.05 |
| 8               | --    | --    | --    | --    | --    | --    | --    | --    | --     | --    |
| 10              | 2.563 | 65.10 | 1.750 | 44.45 | 2.250 | 57.15 | 1.500 | 38.10 | .750   | 19.05 |
| 12              | 2.563 | 65.10 | 1.750 | 44.45 | 2.250 | 57.15 | 1.188 | 30.16 | 1.000  | 25.40 |

**Panel Cutout Dimensions**

| Reference | A     |       | B     |       | C     |       |
|-----------|-------|-------|-------|-------|-------|-------|
|           | in    | mm    | in    | mm    | in    | mm    |
| 303-FP    | .953  | 24.21 | .516  | 13.11 | 1.750 | 44.45 |
| 304-FP    | .703  | 17.86 | .766  | 19.46 | 1.750 | 44.45 |
| 306-FP    | .953  | 24.21 | .766  | 19.46 | 1.750 | 44.45 |
| 308-FP    | --    | --    | --    | --    | --    | --    |
| 310-FP    | 1.516 | 38.51 | .766  | 19.46 | 2.250 | 57.15 |
| 312-FP    | 1.203 | 30.56 | 1.016 | 25.81 | 2.250 | 57.15 |

Marketed exclusively through distribution.

**300 Series with End Brackets (EB)**

| No. of Contacts | Catalog No. Plug | Catalog No. Socket |
|-----------------|------------------|--------------------|
| 15              | P-315-EB         | S-315-EB           |
| 18              | P-318-EB         | S-318-EB           |
| 21              | P-321-EB         | S-321-EB           |
| 24              | P-324-EB         | S-324-EB           |
| 28              | P-328-EB         | S-328-EB           |
| 30              | P-330-EB         | S-330-EB           |
| 33              | P-333-EB         | S-333-EB           |

NOTE: Not available in contact sizes 2-12.

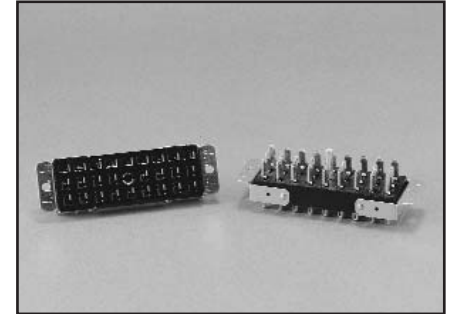

2

X = length of plug contacts. This dimension does not apply to sockets.  
Y = length of plug or socket tails.



**Dimensions**

| No. of Contacts | L             |        | M             |       | P              |       | Polarizing Pin |
|-----------------|---------------|--------|---------------|-------|----------------|-------|----------------|
|                 | ±.031 (.79mm) |        | ±.031 (.79mm) |       | ±.063 (1.59mm) |       |                |
| 15              | 2.313         | 58.75  | 2.000         | 50.80 | 1.625          | 41.28 | NO             |
| 18              | 2.625         | 66.68  | 2.313         | 58.75 | 1.938          | 49.23 | NO             |
| 21              | 2.938         | 74.63  | 2.625         | 66.68 | 2.250          | 57.15 | NO             |
| 24              | 3.250         | 82.55  | 2.938         | 74.63 | 2.563          | 65.10 | 14             |
| 27              | 3.563         | 90.50  | 3.250         | 82.55 | 2.875          | 73.03 | 14             |
| 30              | 3.875         | 98.43  | 3.563         | 90.50 | 3.188          | 80.98 | 14             |
| 33              | 4.188         | 106.38 | 3.875         | 98.43 | 3.500          | 88.90 | 17             |

**Panel Cutout Dimensions**

| Reference | A     |       | B     |       | C     |       |
|-----------|-------|-------|-------|-------|-------|-------|
|           | in    | mm    | in    | mm    | in    | mm    |
| 315-EB    | 1.641 | 41.68 | 1.016 | 25.81 | 2.000 | 50.80 |
| 318-EB    | 1.953 | 49.61 | 1.016 | 25.81 | 2.313 | 58.75 |
| 321-EB    | 2.266 | 57.56 | 1.016 | 25.81 | 2.625 | 66.68 |
| 324-EB    | 2.578 | 65.48 | 1.016 | 25.81 | 2.938 | 74.63 |
| 327-EB    | 2.891 | 73.43 | 1.016 | 25.81 | 3.250 | 82.55 |
| 330-EB    | 3.203 | 81.36 | 1.016 | 25.81 | 3.563 | 90.50 |
| 333-EB    | 3.516 | 89.31 | 1.016 | 25.81 | 3.875 | 98.43 |

Marketed exclusively through distribution.

**300 Series with Recessed Plate (RP)**

| No. of Contacts | Catalog No. Plug | Catalog No. Socket |
|-----------------|------------------|--------------------|
| 2               | P-302-RP         | S-302-RP           |
| 3               | P-303-RP         | S-303-RP           |
| 4               | P-304-RP         | S-304-RP           |
| 6               | P-306-RP         | S-306-RP           |
| 8               | N/A              | N/A                |
| 10              | P-310-RP         | N/A                |
| 12              | P-312-RP         | N/A                |

NOTE: Not available in contact sizes 15-33.



Y = length of plug or socket tails.

**Dimensions**

| No. of Contacts | A     |       | B     |       | C     |       | D Max. |       |
|-----------------|-------|-------|-------|-------|-------|-------|--------|-------|
|                 | in    | mm    | in    | mm    | in    | mm    | in     | mm    |
| 2               | 2.063 | 52.40 | 1.500 | 38.10 | 1.750 | 44.45 | 1.350  | 34.29 |
| 3               | 2.063 | 52.40 | 1.500 | 38.10 | 1.750 | 44.45 | 1.350  | 34.29 |
| 4               | 2.063 | 52.40 | 1.500 | 38.10 | 1.750 | 44.45 | 1.350  | 34.29 |
| 6               | 2.063 | 52.40 | 1.500 | 38.10 | 1.750 | 44.45 | 1.350  | 34.29 |
| 8               | --    | --    | --    | --    | --    | --    | --     | --    |
| 10              | 2.563 | 65.10 | 2.000 | 50.80 | 2.250 | 57.15 | 1.850  | 46.99 |
| 12              | 2.563 | 65.10 | 2.000 | 50.80 | 2.250 | 57.15 | 1.850  | 46.99 |

Marketed exclusively through distribution.

**300 Series with Shallow Bracket (SB)**

| No. of Contacts | Catalog No. Plug | Catalog No. Socket |
|-----------------|------------------|--------------------|
| 15              | P-315-SB         | S-315-SB           |
| 18              | P-318-SB         | S-318-SB           |
| 21              | P-321-SB         | S-321-SB           |
| 24              | P-324-SB         | S-324-SB           |
| 27              | P-327-SB         | S-327-SB           |
| 30              | P-330-SB         | S-330-SB           |
| 33              | P-333-SB         | S-333-SB           |

NOTE: Not available in contact sizes 2-12.

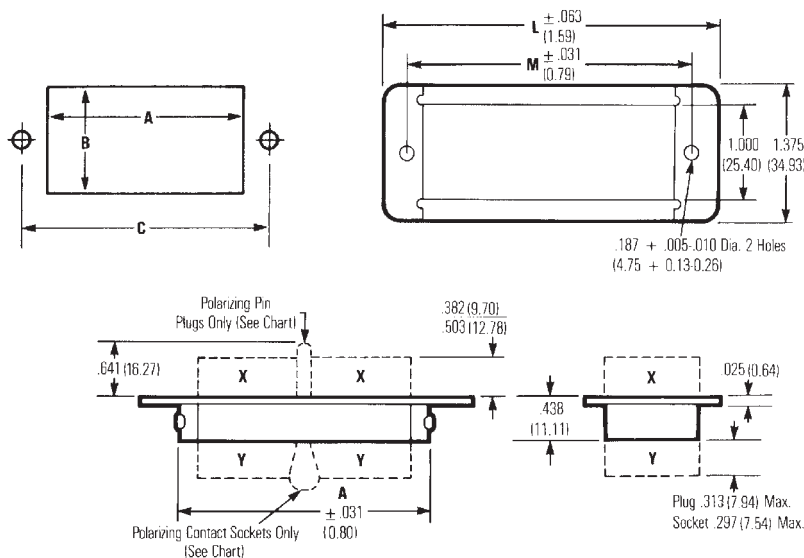

X = length of plug contacts. This dimension does not apply to sockets.  
Y = length of plug or socket tails.

**Dimensions**

| No. of Polarizing Contacts | A                  |       | M                  |        | L                   |        | Polarizing Pin |
|----------------------------|--------------------|-------|--------------------|--------|---------------------|--------|----------------|
|                            | $\pm .031$ (.79mm) |       | $\pm .031$ (.79mm) |        | $\pm .063$ (1.59mm) |        |                |
|                            | in                 | mm    | in                 | mm     | in                  | mm     |                |
| 15                         | 1.688              | 42.86 | 2.125              | 53.98  | 2.547               | 64.69  | NO             |
| 18                         | 2.000              | 50.80 | 2.438              | 61.93  | 2.859               | 72.62  | NO             |
| 21                         | 2.313              | 58.75 | 2.750              | 69.85  | 3.172               | 80.57  | NO             |
| 24                         | 2.625              | 66.68 | 2.063              | 52.40  | 3.484               | 88.49  | 14             |
| 27                         | 2.938              | 74.63 | 3.375              | 85.73  | 3.797               | 96.44  | 14             |
| 30                         | 3.250              | 82.55 | 3.688              | 93.68  | 4.109               | 104.38 | 14             |
| 33                         | 3.563              | 90.50 | 4.000              | 101.60 | 4.422               | 112.32 | 17             |

**Panel Cutout Dimensions**

| Reference | A     |       | B     |       | C     |        |
|-----------|-------|-------|-------|-------|-------|--------|
|           | in    | mm    | in    | mm    | in    | mm     |
| 315-SB    | 1.750 | 44.45 | 1.156 | 29.36 | 2.125 | 53.98  |
| 318-SB    | 2.063 | 52.40 | 1.156 | 29.36 | 2.438 | 61.93  |
| 321-SB    | 2.375 | 60.33 | 1.156 | 29.36 | 2.750 | 69.85  |
| 324-SB    | 2.688 | 68.28 | 1.156 | 29.36 | 3.062 | 77.77  |
| 327-SB    | 3.000 | 76.20 | 1.156 | 29.36 | 3.376 | 85.75  |
| 330-SB    | 3.313 | 84.15 | 1.156 | 29.36 | 3.688 | 93.68  |
| 333-SB    | 3.625 | 92.08 | 1.156 | 29.36 | 4.000 | 101.60 |

Marketed exclusively through distribution.

**300 Series Deep Bracket (DB)**

| No. of Contacts | Catalog No. Plug | Catalog No. Socket |
|-----------------|------------------|--------------------|
| 2               | P-302-DB         | S-302-DB           |
| 3               | P-303-DB         | S-303-DB           |
| 4               | P-304-DB         | S-304-DB           |
| 6               | P-306-DB         | S-306-DB           |
| 8               | N/A              | N/A                |
| 10              | N/A              | N/A                |
| 12              | P-312-DB         | N/A                |
| 15              | P-315-DB         | S-315-DB           |
| 18              | P-318-DB         | S-318-DB           |
| 21              | P-321-DB         | S-321-DB           |
| 24              | P-324-DB         | S-324-DB           |
| 27              | P-327-DB         | S-327-DB           |
| 30              | P-330-DB         | S-330-DB           |
| 33              | P-333-DB         | S-333-DB           |



**Dimensions**

Y = length of plug or socket tails.

| No. of Contacts | L<br>±.063 (1.60mm) |        | M<br>±.031 (.79mm) |        | Polarizing Pin |
|-----------------|---------------------|--------|--------------------|--------|----------------|
|                 | in                  | mm     | in                 | mm     |                |
| 15              | 2.813               | 71.44  | 2.375              | 60.33  | NO             |
| 18              | 3.125               | 79.38  | 2.688              | 68.28  | NO             |
| 21              | 3.437               | 87.31  | 3.000              | 76.20  | NO             |
| 24              | 3.750               | 95.25  | 3.313              | 84.15  | 14             |
| 27              | 4.063               | 103.19 | 3.625              | 92.08  | 14             |
| 30              | 4.375               | 111.13 | 3.938              | 100.03 | 14             |
| 33              | 4.688               | 119.06 | 4.250              | 107.95 | 17             |

**Panel Cutout Dimensions**

| Reference   | A     |       | B     |       | C     |        |
|-------------|-------|-------|-------|-------|-------|--------|
|             | in    | mm    | in    | mm    | in    | mm     |
| 302-DB thru |       |       |       |       |       |        |
| 312-DB      | 1.453 | 36.91 | 1.125 | 28.58 | 1.750 | 38.10  |
| 315-DB      | 2.000 | 50.80 | 1.438 | 36.53 | 2.376 | 60.35  |
| 318-DB      | 2.313 | 58.75 | 1.438 | 36.53 | 2.688 | 68.28  |
| 321-DB      | 2.625 | 66.68 | 1.438 | 36.53 | 3.000 | 76.20  |
| 324-DB      | 2.938 | 74.63 | 1.438 | 36.53 | 3.312 | 84.12  |
| 327-DB      | 3.250 | 82.55 | 1.438 | 36.53 | 3.626 | 92.10  |
| 330-DB      | 3.562 | 90.47 | 1.438 | 36.53 | 3.938 | 100.03 |
| 333-DB      | 3.875 | 98.43 | 1.438 | 36.53 | 4.250 | 107.95 |

Marketed exclusively through distribution.

**300 Series with Hood and 90° Cable Clamp (CCE)**

| No. of Contacts | Catalog No. Plug | Catalog No. Socket |
|-----------------|------------------|--------------------|
| 2               | P-302-CCE        | S-302-CCE          |
| 3               | P-303-CCE        | S-303-CCE          |
| 4               | P-304-CCE        | S-304-CCE          |
| 6               | P-306-CCE        | S-306-CCE          |
| 8               | N/A              | N/A                |
| 10              | P-310-CCE        | N/A                |
| 12              | P-312-CCE        | N/A                |
| 15              | P-315-CCE        | S-315-CCE          |
| 18              | P-318-CCE        | S-318-CCE          |
| 21              | P-321-CCE        | S-321-CCE          |
| 24              | P-324-CCE        | S-324-CCE          |
| 27              | P-327-CCE        | S-327-CCE          |
| 30              | P-330-CCE        | S-330-CCE          |
| 33              | P-333-CCE        | S-333-CCE          |



**Dimensions**

| No. of Contacts | A ±.016 (.41mm) |       | B ±.016 (.41mm) |       | C ±.031 (.79mm) |       | G    |       | Cable "D" Opening |       |
|-----------------|-----------------|-------|-----------------|-------|-----------------|-------|------|-------|-------------------|-------|
|                 | in              | mm    | in              | mm    | in              | mm    | in   | mm    | in                | mm    |
| 2               | .691            | 17.55 | -               | -     | .953            | 24.21 | .313 | 7.95  | .313              | 7.95  |
| 3               | 1.034           | 26.26 | .472            | 11.99 | .953            | 24.21 | .344 | 8.74  | .250              | 6.35  |
| 4               | .786            | 19.96 | .724            | 18.39 | .953            | 24.21 | .453 | 11.51 | .375              | 9.53  |
| 6               | 1.036           | 26.31 | .724            | 18.39 | .078            | 27.38 | .469 | 11.91 | .438              | 11.13 |
| 8               | --              | --    | --              | --    | --              | --    | --   | --    | --                | --    |
| 10              | 1.592           | 40.44 | .720            | 18.29 | 1.203           | 30.56 | .359 | 9.12  | .500              | 12.70 |
| 12              | 1.286           | 32.66 | .974            | 24.74 | 1.203           | 30.56 | .422 | 10.72 | .563              | 14.30 |

| No. of Contacts | E     |        | L     |       | Cable Opening |       | Polarizing Pin |
|-----------------|-------|--------|-------|-------|---------------|-------|----------------|
|                 | in    | mm     | in    | mm    | in            | mm    |                |
| 15              | 2.514 | 63.85  | 1.795 | 45.59 | .563          | 14.30 | NO             |
| 18              | 2.826 | 71.78  | 2.107 | 53.52 | .563          | 14.30 | NO             |
| 21              | 3.139 | 79.73  | 2.420 | 61.47 | .625          | 15.88 | NO             |
| 24              | 3.451 | 87.66  | 2.732 | 69.39 | .625          | 15.88 | 14             |
| 27              | 3.764 | 95.61  | 3.045 | 77.34 | .625          | 15.88 | 14             |
| 30              | 4.076 | 103.53 | 3.357 | 85.27 | .750          | 19.05 | 14             |
| 33              | 4.389 | 111.48 | 3.670 | 93.22 | .750          | 19.05 | 17             |

Marketed exclusively through distribution.



**300 Series with Hood and 180° Cable Clamp (CCT)**

| No. of Contacts | Catalog No. Plug | Catalog No. Socket |
|-----------------|------------------|--------------------|
| 2               | P-302-CCT        | S-302-CCT          |
| 3               | P-303-CCT        | S-303-CCT          |
| 4               | P-304-CCT        | S-304-CCT          |
| 6               | P-306-CCT        | S-306-CCT          |
| 8               | N/A              | N/A                |
| 10              | P-310-CCT        | N/A                |
| 12              | P-312-CCT        | N/A                |
| 15              | P-315-CCT        | S-315-CCT          |
| 18              | P-318-CCT        | S-318-CCT          |
| 21              | P-321-CCT        | S-321-CCT          |
| 24              | P-324-CCT        | S-324-CCT          |
| 27              | P-327-CCT        | S-327-CCT          |
| 30              | P-330-CCT        | S-330-CCT          |
| 33              | P-333-CCT        | S-333-CCT          |

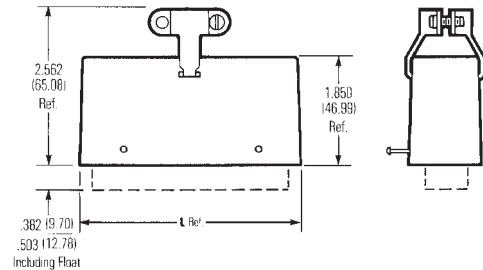

**Dimensions**

| No. of Contacts | A ±.016 (.41mm) |       | B ±.016 (.41mm) |       | C ±.031 (.79mm) |       | "D" Cable Opening |       | E ±.031 (.79mm) |       |
|-----------------|-----------------|-------|-----------------|-------|-----------------|-------|-------------------|-------|-----------------|-------|
|                 | in              | mm    | in              | mm    | in              | mm    | in                | mm    | in              | mm    |
| 2               | .691            | 17.55 | -               | -     | .953            | 24.21 | .375              | 9.53  | .359            | 9.12  |
| 3               | 1.034           | 26.26 | .472            | 11.99 | .953            | 24.21 | .313              | 7.95  | .359            | 9.12  |
| 4               | .786            | 19.96 | .724            | 18.39 | .953            | 24.21 | .375              | 9.53  | .469            | 11.91 |
| 6               | 1.036           | 26.31 | .724            | 18.39 | 1.078           | 27.38 | .438              | 11.13 | .484            | 12.29 |
| 8               | --              | --    | --              | --    | --              | --    | --                | --    | --              | --    |
| 10              | 1.592           | 40.44 | .720            | 18.29 | 1.203           | 30.56 | .500              | 12.70 | .500            | 12.70 |
| 12              | 1.286           | 32.66 | .974            | 24.74 | 1.203           | 30.56 | .563              | 14.30 | .469            | 11.91 |

| No. of Contacts | L     |       | Cable Opening |       | Polarizing Pin |
|-----------------|-------|-------|---------------|-------|----------------|
|                 | in    | mm    | in            | mm    |                |
| 15              | 1.795 | 45.59 | .563          | 14.30 | NO             |
| 18              | 2.107 | 53.52 | .563          | 14.30 | NO             |
| 21              | 2.420 | 61.47 | .625          | 15.88 | NO             |
| 24              | 2.732 | 69.39 | .625          | 15.88 | 14             |
| 27              | 3.045 | 77.34 | .625          | 15.88 | 14             |
| 30              | 3.357 | 85.27 | .750          | 19.05 | 14             |
| 33              | 3.670 | 93.22 | .750          | 19.05 | 17             |

Marketed exclusively through distribution.

**Jones  
Plugs/Sockets  
Series 300**

Multiple Density  
Solder Eyelet  
180° Clamp w/Locks



**300 Series Plug with Hood and Lock (CCT-L) and Socket with Hood and Keeper (CCT-K)**

| No. of Contacts | Catalog No. Plug w/ Lock | Catalog No. Socket w/ Keeper |
|-----------------|--------------------------|------------------------------|
| 2               | P-302-CCT-L              | S-302-CCT-K                  |
| 3               | P-303-CCT-L              | S-303-CCT-K                  |
| 4               | P-304-CCT-L              | S-304-CCT-K                  |
| 6               | P-306-CCT-L              | S-306-CCT-K                  |
| 8               | N/A                      | N/A                          |
| 10              | P-310-CCT-L              | N/A                          |
| 12              | P-312-CCT-L              | N/A                          |
| 15              | P-315-CCT-L              | S-315-CCT-K                  |
| 18              | P-318-CCT-L              | S-318-CCT-K                  |
| 21              | P-321-CCT-L              | S-321-CCT-K                  |
| 24              | P-324-CCT-L              | S-324-CCT-K                  |
| 27              | P-327-CCT-L              | S-327-CCT-K                  |
| 30              | P-330-CCT-L              | S-330-CCT-K                  |
| 33              | P-333-CCT-L              | S-333-CCT-K                  |



2



**Dimensions**

| No. of Contacts | A ±.016 (.41mm) |       | B ±.016 (.41mm) |       | C ±.031 (.79mm) |       | F    |       | "D" Cable Opening |       | Polarizing Pin |
|-----------------|-----------------|-------|-----------------|-------|-----------------|-------|------|-------|-------------------|-------|----------------|
|                 | in              | mm    | in              | mm    | in              | mm    | in   | mm    | in                | mm    |                |
| 2               | .691            | 17.5  | -               | -     | .953            | 24.21 | .359 | 9.12  | .375              | 9.53  | --             |
| 3               | 1.034           | 26.26 | .472            | 11.99 | .953            | 24.21 | .359 | 9.12  | .313              | 7.94  | --             |
| 4               | .786            | 19.96 | .724            | 18.39 | .953            | 24.21 | .469 | 11.91 | .375              | 9.53  | --             |
| 6               | 1.036           | 26.31 | .724            | 18.39 | 1.078           | 27.38 | .484 | 12.29 | .438              | 11.13 | --             |
| 8               | --              | --    | --              | --    | --              | --    | --   | --    | --                | --    | --             |
| 10              | 1.592           | 40.44 | .720            | 18.29 | 1.203           | 30.56 | .500 | 12.70 | .500              | 12.70 | --             |
| 12              | 1.286           | 32.66 | .974            | 24.74 | 1.203           | 30.56 | .469 | 11.91 | .563              | 14.30 | --             |
| 15              | 1.795           | 45.59 | 1.100           | 27.94 | 1.850           | 46.99 | .712 | 18.08 | .563              | 14.30 | NO             |
| 18              | 2.107           | 53.52 | 1.100           | 27.94 | 1.850           | 46.99 | .712 | 18.08 | .563              | 14.30 | NO             |
| 21              | 2.420           | 61.47 | 1.100           | 27.94 | 1.850           | 46.99 | .712 | 18.08 | .625              | 15.88 | NO             |
| 24              | 2.732           | 69.39 | 1.100           | 27.94 | 1.850           | 46.99 | .712 | 18.08 | .625              | 15.88 | 14             |
| 27              | 3.045           | 77.34 | 1.100           | 27.94 | 1.850           | 46.99 | .712 | 18.08 | .625              | 15.88 | 14             |
| 30              | 3.357           | 85.27 | 1.100           | 27.94 | 1.850           | 46.99 | .712 | 18.08 | .750              | 19.05 | 14             |
| 33              | 3.670           | 93.22 | 1.100           | 27.94 | 1.850           | 46.99 | .712 | 18.08 | .750              | 19.05 | 17             |

Marketed exclusively through distribution.

**JONES PLUGS AND SOCKETS 300 SERIES MATING CHART**

PLUGS

| MOUNTING CONFIG. | AB | DB | FP | RP | EB | SB | CCE | CCT | CCT-L | CCT-K | LAB |
|------------------|----|----|----|----|----|----|-----|-----|-------|-------|-----|
| AB               | ●* |    | ●* |    | ●* | ●* | ●   | ●   |       |       | ●   |
| DB               |    |    |    |    |    |    |     | ●   |       |       | ●   |
| FP               | ●* |    | ●* |    | ●* |    | ●   | ●   |       |       | ●   |
| RP               |    |    |    |    |    |    | ●   | ●   |       |       | ●   |
| EB               | ●* |    | ●* |    | ●* |    | ●   | ●   |       |       | ●   |
| SB               | ●* |    |    |    | ●* | ●* | ●   | ●   |       |       | ●   |
| CCE              | ●  |    | ●  | ●  | ●  | ●  | ●   | ●   |       |       | ●   |
| CCT              | ●  | ●  | ●  | ●  | ●  | ●  | ●   | ●   |       |       | ●   |
| CCT-L            |    |    |    |    |    |    |     |     |       | ●     |     |
| CCT-K            |    |    |    |    |    |    |     |     | ●     |       |     |
| LAB              | ●  | ●  | ●  | ●  | ●  | ●  | ●   | ●   | ●     | ●     | ●   |

- These are recommended configurations.
- \* These are possible configurations, but not normally recommended.

NOTE: Cinch layout S315-12 is available only in "AB" or "LAB".

**Replacement Drive Pins for Series 300 Plugs and Sockets with Cable Caps and Clamps**

**Dimensions**

**Ordering Information**

| No. of Contacts | Dim. L               |       | No. of Contacts | Catalog No. |
|-----------------|----------------------|-------|-----------------|-------------|
|                 | + .005 (.13mm)<br>in | mm    |                 |             |
| 2               | .687                 | 17.45 | 2               | 302R        |
| 3               | .468                 | 11.89 | 3               | 303R        |
| 4,6,8,10*       | .718                 | 18.24 | 4,6,8,10*       | 304R        |
| 12              | .953                 | 28.58 | 12              | 312R        |
| 15-33*          | 1.125                | 28.58 | 15-33*          | 333R        |



\*10 contact size and 15 through 33 contact sizes require two pins per unit; all other sizes require only one.

Marketed exclusively through distribution.

FEATURES

- For use in cable-to-cable and cable-to-panel applications.
- Designed for medium duty.
- Plug prongs are .250" (6.35mm) wide and .055" (1.40mm) thick.
- Socket contacts have solder eyelet contacts of .093" diameters.
- Polarized to prevent wrong-way insertion.
- Plugs have projecting flat blades, sockets have recessed twin bellows.
- Cable clamps of zinc and clear irridite-plated steel are used for strain relief.
- Bifurcated bellows socket contact provides four individual flexing surfaces for maximum contact with the blade.
- Plugs and sockets have recessed pockets with barriers around the contacts.
- A shoulder extends around the face (mating) side of both plug and socket presenting a finished appearance when mounted in bracket or cap.
- Intermates with existing 400 Series Products on the market.
- UL Recognized - file - E17021B (UL1977) E130965 (1863).
- CSA - LR31996-2.
- Panel cutout dimensions (See page 2-57).

MATERIALS

**Insulation Material:** Molded monoblock, general purpose phenolic, black

**Contact Material:** Plug: Brass  
Socket: Phosphor bronze

**Contact Plating:** Cadmium

**Operating Temperature:** Up to +105°C

**Hood Material:** Formed metal with dielectric liner in hood to prevent shorting

ELECTRICAL

**Operating Voltage:** 250 VAC RMS  
**Current Rating:** 15 Amps  
**Current Resistance:** 1.0 Milliohms maximum

POLARIZING PATTERNS FOR SERIES 2400



2402



2404



2406



2408



2410



2412

**2400 Series Less Angle Bracket**

| No. of Contacts | Catalog No. Plug | Catalog No. Socket |
|-----------------|------------------|--------------------|
| 2               | N/A              | S-2402-LAB         |
| 4               | P-2404-LAB       | S-2404-LAB         |
| 6               | P-2406-LAB       | S-2406-LAB         |
| 8               | P-2408-LAB       | S-2408-LAB         |
| 10              | P-2410-LAB       | S-2410-LAB         |
| 12              | P-2412-LAB       | S-2412-LAB         |



**Plug**

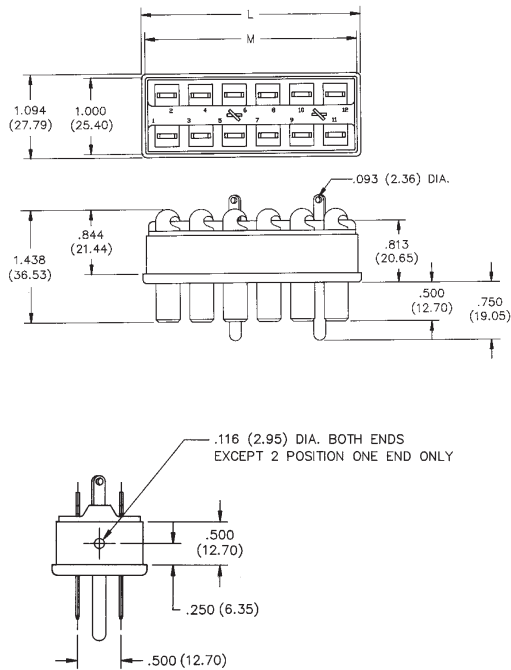

**Socket**



**Dimensions - Plug or Socket**

| No. of Contacts | M     |       | L     |       |
|-----------------|-------|-------|-------|-------|
|                 | in    | mm    | in    | mm    |
| 2               | .563  | 14.29 | .656  | 16.67 |
| 4               | 1.000 | 25.40 | 1.094 | 27.78 |
| 6               | 1.438 | 36.51 | 1.531 | 38.89 |
| 8               | 1.875 | 47.63 | 1.969 | 50.01 |
| 10              | 2.313 | 58.74 | 2.406 | 61.12 |
| 12              | 2.750 | 69.85 | 1.844 | 46.83 |

Marketed exclusively through distribution.

**Jones  
Plugs/Sockets  
Series 2400**

Multiple Density  
Solder Eyelet  
With Angle Bracket



2400 Series with Angle Bracket

| No. of Contacts | Catalog No. Plug | Catalog No. Socket |
|-----------------|------------------|--------------------|
| 2               | N/A              | S-2402-AB          |
| 4               | P-2404-AB        | S-2404-AB          |
| 6               | P-2406-AB        | S-2406-AB          |
| 8               | P-2408-AB        | S-2408-AB          |
| 10              | P-2410-AB        | S-2410-AB          |
| 12              | P-2412-AB        | S-2412-AB          |



**Plug**



**Socket**



**Dimensions - Plug or Socket**

| No. of Contacts | M     |       | L     |       |
|-----------------|-------|-------|-------|-------|
|                 | in    | mm    | in    | mm    |
| 2               | .563  | 14.29 | .656  | 16.67 |
| 4               | 1.000 | 25.40 | 1.094 | 27.78 |
| 6               | 1.438 | 36.51 | 1.531 | 38.89 |
| 8               | 1.875 | 47.63 | 1.969 | 50.01 |
| 10              | 2.313 | 58.74 | 2.406 | 61.12 |
| 12              | 2.750 | 69.85 | 2.844 | 72.24 |

Panel Cutout dimensions are on page 2-61.

Marketed exclusively through distribution.

**2400 Series with Shallow Bracket**

| No. of Contacts | Catalog No. Plug | Catalog No. Socket |
|-----------------|------------------|--------------------|
| 2               | N/A              | S-2402-SB          |
| 4               | P-2404-SB        | S-2404-SB          |
| 6               | P-2406-SB        | S-2406-SB          |
| 8               | P-2408-SB        | S-2408-SB          |
| 10              | P-2410-SB        | S-2410-SB          |
| 12              | P-2412-SB        | S-2412-SB          |



2

**Plug**



**Socket**



**Dimensions - Plug or Socket**

| No. of Contacts | L     |       | M     |       | R. Max. |       |
|-----------------|-------|-------|-------|-------|---------|-------|
|                 | in    | mm    | in    | mm    | in      | mm    |
| 2               | 1.500 | 38.10 | 1.062 | 26.99 | 1.766   | 19.45 |
| 4               | 1.937 | 49.21 | 1.500 | 38.10 | 1.234   | 31.34 |
| 6               | 2.375 | 60.33 | 1.938 | 49.23 | 1.672   | 42.47 |
| 8               | 2.813 | 71.45 | 2.375 | 60.33 | 2.109   | 53.57 |
| 10              | 3.250 | 82.55 | 2.813 | 71.45 | 2.547   | 64.69 |
| 12              | 3.688 | 93.68 | 3.250 | 82.55 | 2.984   | 75.80 |

Panel Cutout dimensions are on page 2-61.

Marketed exclusively through distribution.

**2400 Series with Deep Bracket**

| No. of Contacts | Catalog No. Plug | Catalog No. Socket |
|-----------------|------------------|--------------------|
| 2               | N/A              | S-2402-DB          |
| 4               | P-2404-DB        | S-2404-DB          |
| 6               | P-2406-DB        | S-2406-DB          |
| 8               | P-2408-DB        | S-2408-DB          |
| 10              | P-2410-DB        | S-2410-DB          |
| 12              | P-2412-DB        | S-2412-DB          |



**Plug**

**Socket**

**Plug or Socket**



**Dimensions - Plug or Socket**

| No. of Contacts | B     |       | L     |        | M     |       |
|-----------------|-------|-------|-------|--------|-------|-------|
|                 | in    | mm    | in    | mm     | in    | mm    |
| 2               | .922  | 23.42 | 1.750 | 44.45  | 1.313 | 33.35 |
| 4               | 1.359 | 34.53 | 2.188 | 55.58  | 1.750 | 44.45 |
| 6               | 1.797 | 45.64 | 2.625 | 57.53  | 2.188 | 55.58 |
| 8               | 2.234 | 56.74 | 3.063 | 77.79  | 2.625 | 66.68 |
| 10              | 2.672 | 67.87 | 3.500 | 88.90  | 3.063 | 77.80 |
| 12              | 3.109 | 78.97 | 3.938 | 100.03 | 3.500 | 88.90 |

Panel Cutout dimensions are on page 2-61.

Marketed exclusively through distribution.



**Jones  
Plugs/Sockets  
Series 2400**

Multiple Density  
Solder Eyelet  
With Hood & 90° Clamp



**2400 Series with Hood and 90° Clamp**

| No. of Contacts | Catalog No. Plug | Catalog No. Socket |
|-----------------|------------------|--------------------|
| 2               | N/A              | S-2402-CCE         |
| 4               | P-2404-CCE       | S-2404-CCE         |
| 6               | P-2406-CCE       | S-2406-CCE         |
| 8               | P-2408-CCE       | S-2408-CCE         |
| 10              | P-2410-CCE       | S-2410-CCE         |
| 12              | P-2412-CCE       | S-2412-CCE         |



**Plug**



**Socket**



**Dimensions - Plug or Socket**

| No. of Contacts | L     |       | C     |       | Cable Opening |       |
|-----------------|-------|-------|-------|-------|---------------|-------|
|                 | in    | mm    | in    | mm    | in            | mm    |
| 2               | .625  | 15.88 | 1.375 | 34.93 | .375          | 9.53  |
| 4               | 1.062 | 26.99 | 1.375 | 34.93 | .438          | 11.11 |
| 6               | 1.500 | 38.10 | 1.375 | 34.93 | .438          | 11.11 |
| 8               | 1.937 | 49.21 | 1.344 | 34.13 | .563          | 14.29 |
| 10              | 2.375 | 60.33 | 1.344 | 34.13 | .563          | 14.29 |
| 12              | 2.813 | 71.45 | 1.312 | 33.34 | .625          | 15.88 |

Marketed exclusively through distribution.

2400 Series with Hood and 180° Clamp

| No. of Contacts | Catalog No. Plug | Catalog No. Socket |
|-----------------|------------------|--------------------|
| 2               | N/A              | S-2402-CCT         |
| 4               | P-2404-CCT       | S-2404-CCT         |
| 6               | P-2406-CCT       | S-2406-CCT         |
| 8               | P-2408-CCT       | S-2408-CCT         |
| 10              | P-2410-CCT       | S-2410-CCT         |
| 12              | P-2412-CCT       | S-2412-CCT         |



**Plug**



**Socket**



**Dimensions - Plug or Socket**

| No. of Contacts | L     |       | Cable Opening |       |
|-----------------|-------|-------|---------------|-------|
|                 | in    | mm    | in            | mm    |
| 2               | .625  | 15.88 | .313          | 7.94  |
| 4               | 1.062 | 26.99 | .438          | 11.11 |
| 6               | 1.500 | 38.10 | .438          | 11.11 |
| 8               | 1.937 | 49.21 | .563          | 14.29 |
| 10              | 2.375 | 60.33 | .563          | 14.29 |
| 12              | 2.813 | 71.45 | .625          | 15.88 |

Marketed exclusively through distribution.

**Panel Cutout Dimensions  
Angle Bracket**

| Reference | A     |       | B     |       | C     |       |
|-----------|-------|-------|-------|-------|-------|-------|
|           | in    | mm    | in    | mm    | in    | mm    |
| P-2402-AB | --    | --    | --    | --    | --    | --    |
| S-2402-AB | 1.188 | 30.16 | 1.008 | 25.60 | 1.015 | 25.78 |
| P-2404-AB |       |       |       |       |       |       |
| S-2404-AB | 1.625 | 41.28 | 1.445 | 36.70 | 1.015 | 25.78 |
| P-2406-AB |       |       |       |       |       |       |
| S-2406-AB | 2.063 | 52.40 | 1.886 | 47.83 | 1.015 | 25.78 |
| P-2408-AB |       |       |       |       |       |       |
| S-2408-AB | 2.500 | 63.50 | 2.320 | 58.93 | 1.015 | 25.78 |
| P-2410-AB |       |       |       |       |       |       |
| S-2410-AB | 2.938 | 74.63 | 2.758 | 70.05 | 1.015 | 25.78 |
| P-2412-AB |       |       |       |       |       |       |
| S-2412-AB | 3.375 | 85.73 | 3.195 | 81.15 | 1.015 | 25.78 |



**Panel Cutout Dimensions  
Shallow Bracket**

| Reference | A     |       | B     |       | C     |       |
|-----------|-------|-------|-------|-------|-------|-------|
|           | in    | mm    | in    | mm    | in    | mm    |
| P-2402-SB |       |       |       |       |       |       |
| S-2402-SB | 1.062 | 27.00 | .813  | 20.64 | 1.156 | 29.37 |
| P-2404-SB |       |       |       |       |       |       |
| S-2404-SB | 1.500 | 38.10 | 1.250 | 31.75 | 1.156 | 29.37 |
| P-2406-SB |       |       |       |       |       |       |
| S-2406-SB | 1.938 | 49.22 | 1.688 | 42.86 | 1.156 | 29.37 |
| P-2408-SB |       |       |       |       |       |       |
| S-2408-SB | 2.376 | 60.34 | 2.125 | 53.98 | 1.156 | 29.37 |
| P-2410-SB |       |       |       |       |       |       |
| S-2410-SB | 2.812 | 71.44 | 2.563 | 65.10 | 1.156 | 29.37 |
| P-2412-SB |       |       |       |       |       |       |
| S-2412-SB | 3.250 | 82.56 | 3.000 | 76.20 | 1.156 | 29.37 |



**Panel Cutout Dimensions  
Deep Bracket**

| Reference | A     |       | B     |       | C     |       |
|-----------|-------|-------|-------|-------|-------|-------|
|           | in    | mm    | in    | mm    | in    | mm    |
| P-2402-DB |       |       |       |       |       |       |
| S-2402-DB | 1.312 | 33.34 | .938  | 23.81 | 1.438 | 36.51 |
| P-2404-DB |       |       |       |       |       |       |
| S-2404-DB | 1.750 | 44.46 | 1.375 | 34.93 | 1.438 | 36.51 |
| P-2406-DB |       |       |       |       |       |       |
| S-2406-DB | 2.188 | 55.56 | 1.813 | 46.04 | 1.438 | 36.51 |
| P-2408-DB |       |       |       |       |       |       |
| S-2408-DB | 2.624 | 66.68 | 2.250 | 57.15 | 1.438 | 36.51 |
| P-2410-DB |       |       |       |       |       |       |
| S-2410-DB | 3.062 | 77.80 | 2.688 | 68.28 | 1.438 | 36.51 |
| P-2412-DB |       |       |       |       |       |       |
| S-2412-DB | 3.500 | 88.90 | 3.125 | 79.38 | 1.438 | 36.51 |



Marketed exclusively through distribution.

## FEATURES

- **Contact positions 3, 4, 5, 6, 7, and 8.**
- **Pre-assembled with standard shielded cable lengths; consult factory for other lengths.**
- **Molded-in strain relief.**
- **Cable and overmold available in standard colors: black or beige.**
- **Contacts available with gold over nickel.**
- **Shielding system designed to meet FCC requirements for EMI/RFI suppression.**
- **UL Recognized - file E170218 (UL1977).**
- **CSA Certified - file LR31996-6.**

## MATERIALS

**Insulation Material:** Plug Insulator: UL 94V-0 rated nylon  
 Plug Overmold: PVC (black or beige)  
 Cable Jacket: PVC (black or beige)

**Contact Material:** Plug: Phosphor bronze

**Contact Plating:**  
**Option 1:** Gold Flash over nickel underplate overall  
**Option 2:** Option 1 plus additional gold in mating area for total thickness of 30µin.

**Shield Material:** Steel

**Shield Plating:** Nickel

**Standard Cable** Shielded cable with 0.197 inch OD jacket over 28 AWG stranded wire

**Composition:** Conductors. Contact factory for custom cable requirements.

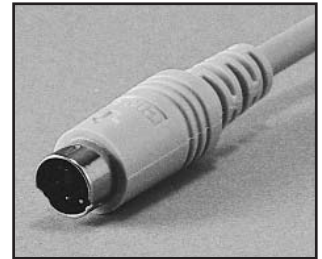

## ENVIRONMENTAL

**Shock:** MIL-STD-202, Method 213, Condition C

**Operating Temperature:** -40°C to +70°C

**Heat Resistance:** 196 hrs. at 100°C

**Salt Spray:** MIL-STD-202, Method 101D, Condition D

**Vibration:** MIL-STD-202, Method 204, Condition B

**Humidity:** MIL-STD-202, Method 103, 48 hrs. at 90-95% RH at 40°C



## ELECTRICAL

**Voltage Rating:** 500 VAC RMS, 707 VDC

**Current Rating:** 1 Amp at 100 VAC  
2 Amps at 12 VDC

**Contact Resistance:** Contact to contact: 30 milliohms maximum  
Shield to shield: 50 milliohms maximum

**Insulation Resistance:** 500 megohms minimum at 500 VDC  
100 megohms minimum after humidity

| PIN NO | COLOR  |
|--------|--------|
| 1      | BLACK  |
| 2      | GREEN  |
| 3      | RED    |
| 4      | BROWN  |
| 5      | BLUE   |
| 6      | WHITE  |
| 7      | YELLOW |
| 8      | GRAY   |

## MECHANICAL

**Durability:** Withstands 500 mating/unmating cycles

**Mating Force:** 10 lb. (4.5 kg) maximum

**Unmating Force:** 1 lb. (0.9 kg) minimum

**Contact Retention:** 3 lb. minimum

Marketed exclusively through distribution.

## Dimensions



### Ordering Information: (NOTE: One meter = 39.62 inches.)

For cable assemblies with plug on one end. Plug features contacts with Option 1 plating (gold flash over nickel).

| No. of Contacts | Cable Length Meter | Black Color Cable & Overmold Catalog No. | Beige Color Cable & Overmold Catalog No. |
|-----------------|--------------------|--|--|
| 3               | 1                  | MDC-3P05                                 | MDC-3P08                                 |
| 4               | 1                  | MDC-4P05                                 | MDC-4P08                                 |
| 4               | 2                  | MDC-4P13                                 | MDC-4P53                                 |
| 4               | 3                  | MDC-4P15                                 | MDC-4P55                                 |
| 5               | 1                  | MDC-5P05                                 | MDC-5P08                                 |
| 6               | 1                  | MDC-6P05                                 | MDC-6P08                                 |
| 6               | 2                  | MDC-6P13                                 | MDC-6P53                                 |
| 6               | 3                  | MDC-6P15                                 | MDC-6P55                                 |
| 7               | 1                  | MDC-7P05                                 | MDC-7P08                                 |
| 7               | 2                  | MDC-7P13                                 | MDC-7P53                                 |
| 7               | 3                  | MDC-7P15                                 | MDC-7P55                                 |
| 8               | 1                  | MDC-8P05                                 | MDC-8P08                                 |
| 8               | 2                  | MDC-8P13                                 | MDC-8P53                                 |
| 8               | 3                  | MDC-8P15                                 | MDC-8P55                                 |

The above cable assemblies are highly recommended for general commercial applications. Contact factory for other lengths or colors.

For cable assemblies with plug on one end. Plug features contacts with Option 2 plating (Option 1 with additional gold in mating area). NOTE: Total gold thickness in mating area is 30 microinches.

| No. of Contacts | Cable Length Meter | Black Color Cable & Overmold Catalog No. | Beige Color Cable & Overmold Catalog No. |
|-----------------|--------------------|--|--|
| 3               | 1                  | MDC-3P06                                 | MDC-3P09                                 |
| 4               | 1                  | MDC-4P06                                 | MDC-4P09                                 |
| 5               | 1                  | MDC-5P06                                 | MDC-5P09                                 |
| 6               | 1                  | MDC-6P06                                 | MDC-6P09                                 |
| 7               | 1                  | MDC-7P06                                 | MDC-7P09                                 |
| 8               | 1                  | MDC-8P06                                 | MDC-8P09                                 |

The above cable assemblies are recommended where greater contact durability is required.

### Additional Capabilities

- Additional lengths or colors of the above cable assemblies can be produced. Consult factory for custom orders.
- Custom-plated contacts can be provided. Consult factory for information.

Marketed exclusively through distribution.

# Circular Mini DIN Plugs

## Plug Components for Cable Termination



FEATURES

- Individual components available for cable assembly with overmolding.
- Plug insulator available with contact positions 3, 4, 5, 6, 7, and 8.
- Seamless shield case is crimped to cable shield; designed to meet FCC requirements for EMI/RFI suppression.
- One-piece shield case - no extra ferrules or shields required with Cinch Shield Crimp Tools.
- Contacts are crimp style and supplied on reels.
- Contacts available with gold over nickel in several options.
- Tools available to facilitate reliable, efficient termination.
- Terminates 24 to 30 AWG wire.
- UL Recognized - file E170218 (UL1977).



MATERIALS

**Insulation Material:** Plug Insulator: 94 V-0 rated nylon

**Contact Material:** Plug: Phosphor bronze

**Contact Plating:**

- Option 1:** Gold flash over nickel underplate overall
- Option 2:** Option 1 plus additional gold in mating area for total thickness of 30µin.
- Option 3:** Option 1 plus additional gold in mating area for total thickness of 50µin.

**Shield Case Material:** Steel

**Shield Case Plating:** Nickel

Cross-Section of Assembly

Crimped Contact



### Dimensions

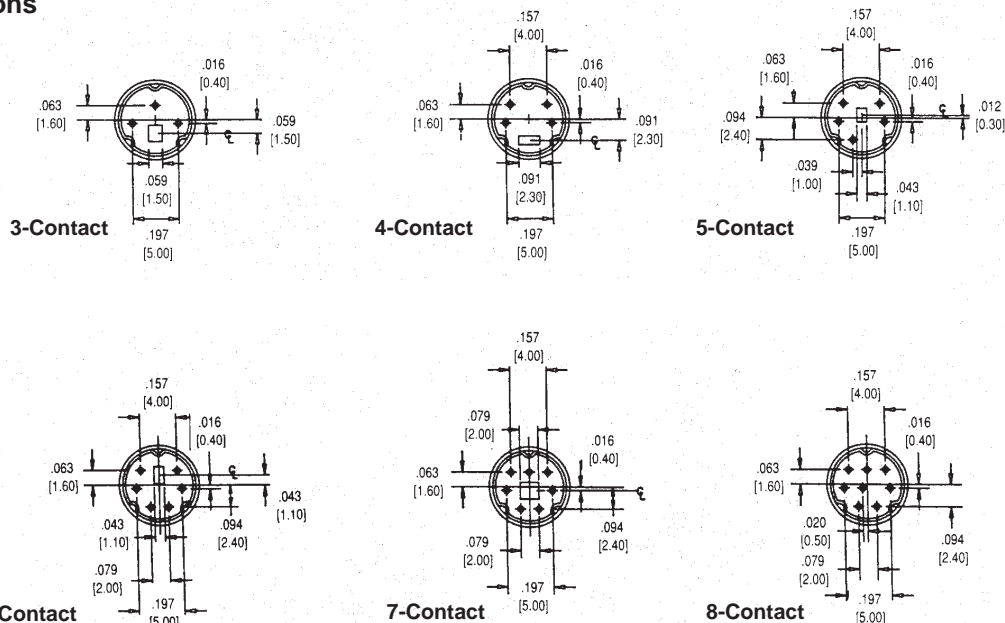

Marketed exclusively through distribution.

### Ordering Information

For each Plug Assembly, the following components are needed: one plug insulator, one shield, and adequate contacts.

| Component Type | Description          | Quantity       | Catalog No. |
|----------------|----------------------|----------------|-------------|
| Insulator      | 3 Position Insulator | 1              | MDX-3PI     |
|                | 4 Position Insulator | 1              | MDX-4PI     |
|                | 5 Position Insulator | 1              | MDX-5PI     |
|                | 6 Position Insulator | 1              | MDX-6PI     |
|                | 7 Position Insulator | 1              | MDX-7PI     |
|                | 8 Position Insulator | 1              | MDX-8PI     |
| Shield Case    | Metal Shield Case    | 1              | MDX-PZ      |
| Contact        | Option 1 Plating     | 300 on Reel    | MDX-P-3A    |
|                | Option 1 Plating     | 15,000 on Reel | MDX-P-15A   |
|                | Option 2 Plating     | 300 on Reel    | MDX-P-3B    |
|                | Option 2 Plating     | 15,000 on Reel | MDX-P-15B   |
|                | Option 3 Plating     | 15,000 on Reel | MDX-P-15D   |

### Tool Ordering Information

The following tools are recommended for Mini Din Cable Plug Assembly. One tool of each type is required.

| Tool Type         | Description  | Catalog No. |
|-------------------|--|-------------|
| Contact Crimp     | Stripper-Crimper Machine Complete, Includes Dies           | MDT-P25     |
|                   | Contact Crimp Hand Tool                                    | MDT-P35     |
|                   | Crimps using 300 Contact Reels                             |             |
| Contact Insertion | Combination Contact Insertion and Insulator Insertion Tool | MDT-P41     |
|                   | Contact Insertion Hand Tool                                | MDT-P28     |
|                   | Fixture used with MDT-P28                                  | MDT-P29     |
|                   | Insulator Insertion Bench Mounted Tool                     | MDT-P34     |
|                   | Insulator Insertion Hand Tool                              | MDT-P30     |
|                   | Pneumatic Crimp Tool                                       | MDT-P81     |

### Overview of Assembly Steps

- Prepare multi-conductor cable.
- Crimp contacts onto individual conductors using tool MDT-P25 or tool MDT-P35.
- Insert contact with conductor into insulator using tool MDT-P41 or have insertion tool MDT-P28 with insulator locating vice MDT-P29.
- Insert insulator into the shield case using tool MDT-P34 or MDT-P30.
- Crimp the shield case onto the cable shield using tool MDT-P81.
- Overmold plastic to complete the assembly.

Marketed exclusively through distribution.

**CARDCON™**  
**Edge Connector**  
**Commercial**

.100" (2.54mm) Density  
 Dip Solder



FEATURES

- *AT and XT versions available.*
- *Dip solder tails on .200" (5.08mm) row centers double readout.*
- *Bifurcated semi-bellows contacts for added contact reliability.*
- *Ideal for applications involving vibration or board irregularities.*
- *Contact positions: 12, 15, 18, 20, 22, 25, 28, 30, 31, 36, 37, 40, 43, 44, 49, 50, 52, 60, 70, AT, and XT.*
- *Accepts .062" (1.59mm) thick PC boards.*
- *Available less mounting ears, or with .128" (3.25mm) mounting holes or 4-40 threaded holes.*
- *Meets applicable performance criteria of MIL-C-21097.*
- *Tube packaging available.*
- *UL Recognized - file E170218 (UL1977) E130965 (UL1863).*



MATERIALS

**Insulation Material:** UL 94V-0 rated glass-filled polyester, black  
**Contact Material:** Spring brass  
**Standard Contact Plating:** 10µin. selective gold over nickel, 50µin. nickel in contact area, tin on tails  
**XT, AT Plating:** 30µin. selective gold over 50µin. nickel in contact area, tin on tails

ENVIRONMENTAL

**Shock:** Per MIL-STD-202E, Method 213, Condition C  
**Operating Temperature:** -65°C to +105°C  
**Vibration:** Per MIL-STD-202E, Method 204, Condition B  
**Humidity:** Per MIL-STD-202, Method 103, Condition B  
**Accessories:**  
**Polarizing Key:** Two types (order separately):  
 a) for between-contact polarization and  
 b) for in-contact polarization.  
 See page 2-74 for more information.  
**Card Guide Posts:** (order separately)  
 Attach to mounting ears and guide PC board into connector. See page 2-74 for more information.

ELECTRICAL

**Withstanding Voltage:** 650 VAC RMS (@ sea level)  
**Current Rating:** 3 Amps  
**Contact Resistance:** 10 Milliohms maximum  
**Insulation Resistance:** 5000 Megohms minimum

MECHANICAL

**Individual Contact Insertion and Separation Force:**  
 12oz. maximum with .070" (1.78mm) blade;  
 1 oz. minimum with .054" (1.37mm) blade

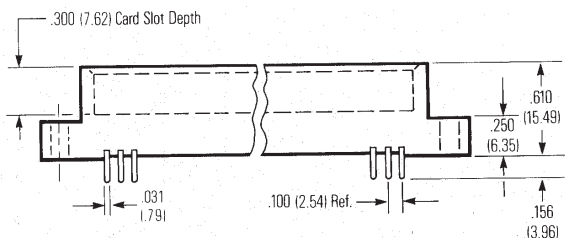

Marketed exclusively through distribution.



**Dimensions**

| No. of<br>Pos./Cont. | A     |        | B     |        | C     |        | D     |        | E     |        | F     |        |
|----------------------|-------|--------|-------|--------|-------|--------|-------|--------|-------|--------|-------|--------|
|                      | in    | mm     | in    | mm     | in    | mm     | in    | mm     | in    | mm     | in    | mm     |
| 12/24                | 1.000 | 25.40  | 1.100 | 27.94  | 1.300 | 33.02  | 1.460 | 37.08  | 1.775 | 45.09  | 2.035 | 51.69  |
| 15/30                | 1.300 | 33.02  | 1.400 | 35.56  | 1.600 | 40.64  | 1.760 | 44.70  | 2.075 | 52.71  | 2.335 | 59.31  |
| 18/36                | 1.600 | 40.64  | 1.700 | 43.18  | 1.900 | 48.26  | 2.060 | 52.32  | 2.375 | 60.33  | 2.635 | 66.93  |
| 18/36+               |       |        |       |        |       |        |       |        |       |        |       |        |
| 31/62IBM             | 5.000 | 127.00 | 5.100 | 129.54 | 5.300 | 134.62 | 5.460 | 138.68 | 5.775 | 146.69 | 6.035 | 153.29 |
| 20/40                | 1.800 | 45.72  | 1.900 | 48.26  | 2.100 | 53.34  | 2.260 | 57.40  | 2.575 | 65.41  | 2.835 | 72.01  |
| 22/24                | 2.000 | 50.80  | 2.100 | 53.34  | 2.300 | 58.42  | 2.460 | 62.48  | 2.775 | 70.49  | 3.035 | 77.09  |
| 25/50                | 2.300 | 58.42  | 2.400 | 60.96  | 2.600 | 66.04  | 2.760 | 70.10  | 3.075 | 78.11  | 3.335 | 84.71  |
| 28/56                | 2.600 | 66.04  | 2.700 | 68.58  | 2.900 | 73.66  | 3.060 | 77.72  | 3.375 | 85.73  | 3.635 | 92.33  |
| 30/60                | 2.800 | 71.12  | 2.900 | 73.66  | 3.100 | 78.74  | 3.260 | 82.80  | 3.575 | 90.81  | 3.835 | 97.41  |
| 31/62                | 2.900 | 73.66  | 3.000 | 76.20  | 3.200 | 81.28  | 3.360 | 85.34  | 3.675 | 93.35  | 3.935 | 99.95  |
| 31/62IBM             | 2.900 | 73.66  | 3.000 | 76.20  | 3.200 | 81.28  | 3.360 | 85.34  | 3.675 | 93.35  | 3.935 | 99.95  |
| 36/72                | 3.400 | 86.36  | 3.500 | 88.90  | 3.700 | 93.98  | 3.860 | 98.04  | 4.175 | 106.05 | 4.435 | 112.63 |
| 37/74                | 3.500 | 88.90  | 3.600 | 91.44  | 3.800 | 96.52  | 3.960 | 100.58 | 4.275 | 108.59 | 4.535 | 115.19 |
| 40/80                | 3.800 | 96.52  | 3.900 | 99.06  | 4.100 | 104.14 | 4.260 | 108.20 | 4.575 | 116.21 | 4.835 | 122.81 |
| 43/86                | 4.100 | 104.14 | 4.200 | 106.68 | 4.400 | 111.76 | 4.560 | 115.82 | 4.875 | 123.83 | 5.135 | 130.43 |
| 44/88                | 4.200 | 106.68 | 4.300 | 109.22 | 4.500 | 114.30 | 4.660 | 118.36 | 4.975 | 126.37 | 5.235 | 132.97 |
| 49/98                | 4.700 | 119.38 | 4.800 | 121.92 | 5.000 | 127.00 | 5.160 | 131.06 | 5.475 | 139.07 | 5.735 | 145.67 |
| 50/100               | 4.800 | 121.92 | 4.900 | 124.46 | 5.100 | 129.54 | 5.260 | 133.60 | 5.575 | 141.61 | 5.835 | 148.21 |
| 52/104               | 5.000 | 127.00 | 5.100 | 129.54 | 5.300 | 134.62 | 5.460 | 138.68 | 5.775 | 146.69 | 6.035 | 153.29 |
| 60/120               | 5.800 | 147.32 | 5.900 | 149.86 | 6.100 | 154.94 | 6.260 | 159.00 | 6.575 | 167.01 | 6.835 | 173.61 |
| 70/140               | 6.800 | 172.72 | 6.900 | 175.26 | 7.100 | 180.34 | 7.260 | 184.40 | 7.575 | 192.41 | 7.835 | 199.01 |

**Ordering Information**

| No. of<br>Pos./Cont. | Less Mounting Ears<br>Catalog No. | .128" (3.25mm)                | 4-40                          |
|----------------------|-----------------------------------|-------------------------------|-------------------------------|
|                      |                                   | Mounting Holes<br>Catalog No. | Threaded Holes<br>Catalog No. |
| 12/24                | 50-12SN-12                        | 50-12SN-11                    | 50-12SN-13                    |
| 15/30                | 50-15SN-12                        | 50-15SN-11                    | 50-15SN-13                    |
| 18/36                | 50-18SN-12                        | 50-18SN-11                    | 50-18SN-13                    |
| 18/36+               |                                   |                               |                               |
| 31/62 IBM            | 50-52SN-AT                        | -                             | -                             |
| 20/40                | 50-20SN-12                        | 50-20SN-11                    | 50-20SN-13                    |
| 22/44                | 50-22SN-12                        | 50-22SN-11                    | 50-22SN-13                    |
| 25/50                | 50-25SN-12                        | 50-25SN-11                    | 50-25SN-13                    |
| 28/56                | 50-28SN-12                        | 50-28SN-11                    | 50-28SN-13                    |
| 30/60                | 50-30SN-12                        | 50-30SN-11                    | 50-30SN-13                    |
| 31/62                | 50-31SN-12                        | 50-31SN-11                    | 50-31SN-13                    |
| 31/62 IBM            | 50-31SN-XT                        | -                             | -                             |
| 36/72                | 50-36SN-12                        | 50-36SN-11                    | 50-36SN-13                    |
| 37/74                | 50-37SN-12                        | 50-37SN-11                    | 50-37SN-13                    |
| 40/80                | 50-40SN-12                        | 50-40SN-11                    | 50-40SN-13                    |
| 43/86                | 50-43SN-12                        | 50-43SN-11                    | 50-43SN-13                    |
| 44/88                | 50-44SN-12                        | 50-44SN-11                    | 50-44SN-13                    |
| 49/98                | 50-49SN-12                        | 50-49SN-11                    | 50-49SN-13                    |
| 50/100               | 50-50SN-12                        | 50-50SN-11                    | 50-50SN-13                    |
| 52/104               | 50-52SN-12                        | 50-52SN-11                    | 50-52SN-13                    |
| 60/120               | 50-60SN-12                        | 50-60SN-11                    | 50-60SN-13                    |
| 70/140               | 50-70SN-12                        | 50-70SN-11                    | 50-70SN-13                    |

Marketed exclusively through distribution.

**CARDCON™**  
**Edge Connector**  
**Commercial**

.156" (3.96mm) Density  
 Dip Solder/Solder Eyelet



FEATURES

- *Dip solder tails single readout and double readout on .140" (3.56mm) row centers or .200" (5.08mm) row centers.*
- *Solder eyelet, single readout and double readout on .200" (5.08mm) row centers.*
- *Available with unique tails for PC board retention; holds the connector firmly on the board during wave soldering operations.*
- *Bifurcated semi-bellows contacts for added contact reliability.*
- *Ideal for applications involving vibration or board irregularities.*
- *Contact positions: 6, 10, 12, 15, 18, 22, 24, and 25.*
- *Accepts single- or double-sided .062" (1.59mm) thick PC boards.*
- *Available less mounting ears or with .128" (3.25mm) mounting hole.*
- *Meets applicable performance criteria of MIL-C-21097.*
- *UL Recognized - file E170218 (UL1977) E130965 (UL1863).*

MATERIALS

**Insulation Material:** UL 94V-0 rated glass-filled polyester, black  
**Contact Material:** Spring brass  
**Contact Plating:** 10µ" selective gold over 30µ" nickel in contact area, tin on tails

ENVIRONMENTAL

**Shock:** Per MIL-STD-202E, Method 213, Condition C  
**Operating Temperature:** -65°C to +105°C  
**Vibration:** Per MIL-STD-202E, Method 204, Condition B  
**Humidity:** Per MIL-STD-202, Method 103, Condition B  
**Accessories:**  
**Polarizing Key:** Two types (order separately):  
 a) for between-contact polarization and  
 b) for in-contact polarization  
 See page 2-72 for more information.  
**Card Guide Posts:** (order separately):  
 Attach to mounting ears and guide PC board into connector  
 See page 2-72 for more information.

ELECTRICAL

**Withstanding Voltage:** 1800 VAC RMS (@ sea level)  
**Current Rating:** 5 Amps  
**Contact Resistance:** 6 Milliohms maximum  
**Insulation Resistance:** 5000 Megohms minimum

MECHANICAL

**Individual Contact Insertion and Separation Force:**  
 16 oz. maximum with .070" (1.78mm) blade;  
 1 oz. minimum with .054" (1.37mm) blade



Marketed exclusively through distribution.

# CARDCON™ Edge Connector Commercial

.156" (3.96mm) Density  
Dip Solder/Solder Eyelet



## Dimensions

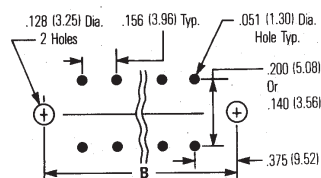

| No. of Pos./Cont. | A     |        | B     |        | C     |        | D     |        |
|-------------------|-------|--------|-------|--------|-------|--------|-------|--------|
|                   | in    | mm     | in    | mm     | in    | mm     | in    | mm     |
| 6/12              | 1.785 | 45.34  | 1.531 | 38.89  | 1.239 | 31.47  | 1.100 | 27.94  |
| 10/20             | 2.410 | 61.21  | 2.156 | 54.76  | 1.874 | 47.34  | 1.724 | 43.79  |
| 12/24             | 2.723 | 69.16  | 2.469 | 62.71  | 2.177 | 55.30  | 2.036 | 51.71  |
| 15/30             | 3.191 | 81.05  | 2.937 | 74.60  | 2.645 | 67.18  | 2.504 | 63.60  |
| 18/36             | 3.660 | 92.96  | 3.406 | 86.51  | 3.114 | 79.10  | 2.972 | 75.49  |
| 22/44             | 4.285 | 108.84 | 4.031 | 102.39 | 3.739 | 94.94  | 3.596 | 91.34  |
| 24/48             | 4.598 | 116.79 | 4.344 | 110.34 | 4.052 | 102.92 | 3.911 | 99.34  |
| 25/50             | 4.754 | 120.75 | 4.500 | 114.30 | 4.208 | 106.88 | 4.067 | 103.30 |

## Ordering Information

No. of Pos./Cont. Less Mounting Ears .128 Mounting Hole Catalog No.

No. of Pos./Cont. Less Mounting Ears .128 Mounting Hole Catalog No.

No. of Pos./Cont. Less Mounting Ears .128 Mounting Hole Catalog No.

### Solder eyelet, single readout

|       |           |           |
|-------|-----------|-----------|
| 6/6   | 50-6SN-8  | 50-6SN-7  |
| 10/10 | 50-10SN-8 | 50-10SN-7 |
| 12/12 | 50-12SN-8 | 50-12SN-7 |
| 15/15 | 50-15SN-8 | 50-15SN-7 |
| 18/18 | 50-18SN-8 | 50-18SN-7 |
| 22/22 | 50-22SN-8 | 50-22SN-7 |
| 24/24 | 50-24SN-8 | 50-24SN-7 |
| 25/25 | 50-25SN-8 | 50-25SN-7 |

### Dip solder tails, single readout, .156" (3.96mm) long

|       |           |           |
|-------|-----------|-----------|
| 6/6   | 50-6SN-6  | 50-6SN-5  |
| 10/10 | 50-10SN-6 | 50-10SN-5 |
| 12/12 | 50-12SN-6 | 50-12SN-5 |
| 15/15 | 50-15SN-6 | 50-15SN-5 |
| 18/18 | 50-18SN-6 | 50-18SN-5 |
| 22/22 | 50-22SN-6 | 50-22SN-5 |
| 24/24 | 50-24SN-6 | 50-24SN-5 |
| 25/25 | 50-25SN-6 | 50-25SN-5 |

### Dip solder tails, double readout, .140" (3.55mm) row spacing, .125" (3.18mm) long

|       |           |           |
|-------|-----------|-----------|
| 6/12  | 50-12SN-4 | 50-12SN-2 |
| 10/20 | 50-20SN-4 | 50-20SN-2 |
| 12/24 | 50-24SN-4 | 50-24SN-2 |
| 15/30 | 50-30SN-4 | 50-30SN-2 |
| 18/36 | 50-36SN-4 | 50-36SN-2 |
| 22/24 | 50-44SN-4 | 50-44SN-2 |
| 24/48 | 50-48SN-4 | 50-48SN-2 |
| 25/50 | 50-50SN-4 | 50-50SN-2 |

### Solder eyelet, double readout, .200" (5.08mm) row spacing

|       |            |           |
|-------|------------|-----------|
| 6/12  | 50-12SN-10 | 50-12SN-9 |
| 10/20 | 50-20SN-10 | 50-20SN-9 |
| 12/24 | 50-24SN-10 | 50-24SN-9 |
| 15/30 | 50-30SN-10 | 50-30SN-9 |
| 18/36 | 50-36SN-10 | 50-36SN-9 |
| 22/24 | 50-44SN-10 | 50-44SN-9 |
| 24/28 | 50-48SN-10 | 50-48SN-9 |
| 25/50 | 50-50SN-10 | 50-50SN-9 |

### Dip solder tails, double readout, .200" (5.08mm) row spacing, .156" (3.96mm) long

|       |           |           |
|-------|-----------|-----------|
| 6/12  | 50-12SN-3 | 50-12SN-1 |
| 10/20 | 50-20SN-3 | 50-20SN-1 |
| 12/24 | 50-24SN-3 | 50-24SN-1 |
| 15/30 | 50-30SN-3 | 50-30SN-1 |
| 18/36 | 50-36SN-3 | 50-36SN-1 |
| 22/44 | 50-44SN-3 | 50-44SN-1 |
| 24/48 | 50-48SN-3 | 50-48SN-1 |
| 25/50 | 50-50SN-3 | 50-50SN-1 |

### Dip solder tails with unique board retention feature .200" (5.08mm) row spacing, .156" (3.96mm) long

|       |            |            |
|-------|------------|------------|
| 6/12  | 50-12SN-3R | 50-12SN-1R |
| 10/20 | 50-20SN-3R | 50-20SN-1R |
| 12/24 | 50-24SN-3R | 50-24SN-1R |
| 15/30 | 50-30SN-3R | 50-30SN-1R |
| 18/36 | 50-36SN-3R | 50-36SN-1R |
| 22/44 | 50-44SN-3R | 50-44SN-1R |
| 24/48 | 50-48SN-3R | 50-48SN-1R |
| 25/50 | 50-50SN-3R | 50-50SN-1R |

Marketed exclusively through distribution.

# Edge Connector High Reliability

.156" (3.96mm) Density Dip  
Solder/Solder Eyelet



## FEATURES

- *Dip solder tails, single readout, .156" (3.96mm) long or .234" (5.94mm) long.*
- *Dip solder tails, double readout, .156" (3.96mm) or .234" (5.94mm) long on .200" (5.08mm) row spacing, or .125" (3.18mm) long on .140" (3.56mm) row spacing.*
- *Solder eyelet, single readout and double readout on .200" (5.08mm) row spacing.*
- *Patented bifurcated bellows contacts for added contact reliability.*
- *Ideal for applications involving vibration or board irregularities.*
- *Contact positions: 6, 10, 12, 15, 18, 22, and 25.*
- *Available with or without mounting ears.*
- *Accepts single- or double-sided .062" (1.59mm) thick PC boards.*
- *UL Recognized - file E170218 (UL1977) E130965 (UL1863).*

## MATERIALS

**Insulation Material:** Diallyl phthalate, green  
**Contact Material:** Phosphor bronze  
**Contact Plating:** 30μ" selective gold over 50μ" copper in the contact areas, 5μ" gold on tails

## ENVIRONMENTAL

**Shock:** Per MIL-STD-202E, Method 202  
**Operating Temperature:** Dip solder: -65°C to +105°C  
 Solder eyelet: -65°C to +125°C  
**Vibration:** Per MIL-STD-202E, Method 204, Condition B  
**Humidity:** Per MIL-STD-202E, Method 103, Condition B  
**Accessories:**  
**Polarizing Key:** Two types (order separately):  
 a) for between-contact polarization and  
 b) for in-contact polarization  
 See page 2-74 for more information.  
**Card Guide Posts:** (order separately):  
 Attach to mounting ears and guide PC board into connector  
 See page 2-74 for more information.

## ELECTRICAL

**Withstanding Voltage:** 1800 VAC RMS (@ sea level)  
**Current Rating:** 5 Amps  
**Contact Resistance:** Dip solder: 6 Milliohms  
 Solder eyelet: 10 Milliohms  
**Insulation Resistance:** 5000 Megohms minimum

## MECHANICAL

**Individual Contact Insertion and Separation Force:**  
 16 oz. maximum with .070" (1.78mm) blade;  
 1 oz. minimum with .054" (1.37mm) blade



Marketed exclusively through distribution.

# Edge Connector High Reliability

.156" (3.96mm) Density Dip  
Solder/Solder Eyelet



### Single Readout



### Double Readout



### With Plain Mounting Holes



Single Readout



Double Readout

### Dimensions

| No. of Pos./Cont. | A     |        | B     |        | C     |        | D     |        |
|-------------------|-------|--------|-------|--------|-------|--------|-------|--------|
|                   | in    | mm     | in    | mm     | in    | mm     | in    | mm     |
| 6                 | 1.100 | 27.94  | 1.239 | 31.47  | 1.531 | 38.80  | 1.785 | 45.34  |
| 10                | 1.724 | 43.79  | 1.864 | 47.35  | 2.156 | 54.76  | 2.410 | 61.21  |
| 12                | 2.036 | 51.71  | 2.177 | 55.30  | 2.469 | 62.71  | 2.723 | 69.16  |
| 15                | 2.504 | 63.60  | 2.645 | 67.18  | 2.937 | 74.60  | 3.191 | 81.05  |
| 18                | 2.972 | 75.49  | 3.114 | 79.10  | 3.406 | 86.51  | 3.660 | 92.96  |
| 20                | 3.286 | 83.46  | 3.427 | 87.05  | 3.719 | 94.46  | 3.973 | 100.91 |
| 22                | 3.596 | 91.34  | 3.739 | 94.97  | 4.031 | 102.39 | 4.285 | 108.84 |
| 25                | 4.067 | 103.30 | 4.208 | 106.88 | 4.500 | 114.30 | 4.754 | 120.75 |

Marketed exclusively through distribution.

Ordering Information

Single Readout

| No. of<br>Pos./Cont. | <b>.128" (3.25mm) Mounting Hole</b> |                            |                      |
|----------------------|-------------------------------------|----------------------------|----------------------|
|                      | <b>Dip Solder Tails</b>             |                            | <b>Solder Eyelet</b> |
|                      | <b>.156" (3.96mm) Long</b>          | <b>.234" (5.94mm) Long</b> |                      |
|                      | <b>Catalog No.</b>                  | <b>Catalog No.</b>         | <b>Catalog No.</b>   |
| 6/6                  | 50-6H-10                            | 50-6S-10                   | 50-6H-20             |
| 10/10                | 50-10H-10                           | 50-10S-10                  | 50-10H-20            |
| 12/12                | 50-12R-10                           | 50-12S-10                  | 50-12H-20            |
| 15/15                | 50-15H-10                           | 50-15S-10                  | 50-15H-20            |
| 18/18                | 50-18H-10                           | 50-18S-10                  | 50-18H-20            |
| 20/20                | 50-20C-10                           | 50-20S-10                  | 50-20A-20            |
| 22/22                | 50-22H-10                           | 50-22S-10                  | 50-22H-20            |
| 25/25                | 50-25H-10                           | 50-25S-10                  | 50-25H-20            |

Double Readout

| No. of<br>Pos./Cont. | <b>.128" (3.25mm) Mounting Hole</b> |                               |                               | <b>Less Mounting Ears</b>     |                               |
|----------------------|-------------------------------------|-------------------------------|-------------------------------|-------------------------------|-------------------------------|
|                      | <b>Solder Eyelet</b>                | <b>Dip Solder Tails</b>       |                               | <b>Dip Solder Tails</b>       |                               |
|                      |                                     | <b>.234" (5.94mm) Long</b>    | <b>.156" (3.96mm) Long</b>    | <b>.125" (3.18mm) Long</b>    | <b>.125" (3.18mm) Long</b>    |
|                      |                                     | <b>.200" (5.08mm) Between</b> | <b>.200" (5.08mm) Between</b> | <b>.140" (3.56mm) Between</b> | <b>.140" (3.56mm) Between</b> |
|                      | <b>Row Spacing</b>                  | <b>Row Spacing</b>            | <b>Row Spacing</b>            | <b>Row Spacing</b>            |                               |
|                      | <b>Catalog No.</b>                  | <b>Catalog No.</b>            | <b>Catalog No.</b>            | <b>Catalog No.</b>            | <b>Catalog No.</b>            |
| 6/12                 | 50-12H-30                           | 50-12S-20                     | 50-12H-10                     | 50-12H-30-2                   | 50-12H-30-1                   |
| 10/20                | 50-20H-30                           | 50-20S-20                     | 50-20H-10                     | 50-20H-30-2                   | 50-20H-30-1                   |
| 12/24                | 50-24H-30                           | 50-24S-20                     | 50-24H-10                     | 50-24H-30-2                   | 50-24H-30-1                   |
| 15/30                | 50-30H-30                           | 50-30S-20                     | 50-30H-10                     | 50-30H-30-2                   | 50-30H-30-1                   |
| 18/36                | 50-36H-30                           | 50-36S-20                     | 50-36H-10                     | 50-36H-30-2                   | 50-36H-30-1                   |
| 20/40                | 50-40A-30                           | 50-40S-20                     | 50-40B-10                     |                               |                               |
| 22/44                | 50-44H-30                           | 50-44S-20                     | 50-44H-10                     | 50-44H-30-2                   | 50-44H-30-1                   |
| 25/50                | 50-50H-30                           | 50-50S-20                     | 50-50H-10                     | 50-50H-30-2                   | 50-50H-30-1                   |



# Edge Connector High Reliability

.156" (3.96mm) Density  
Card Extender



## FEATURES

- **Solder terminations, double readout.**
- **Bifurcated bellows type contacts.**
- **Contact positions: 6, 10, 12, 15, 18, 22, and 25.**
- **Accepts .062" (1.59mm) thick double-sided PC boards.**

## MATERIALS

**Insulation Material:** Diallyl phthalate, green  
**Contact Material:** Beryllium copper  
**Contact Plating:** 30µin. select gold over 50µin. nickel in the contact areas, 10µin. gold tails



## ENVIRONMENTAL

**Shock:** Per MIL-STD-202E, Method 213, Condition C  
**Operating Temperature:** -65°C to +125°C  
**Vibration:** Per MIL-STD-202E, Method 204, Condition B  
**Humidity:** Per MIL-STD-202E, Method 103, Condition B

## ELECTRICAL

**Withstanding Voltage:** 830 VAC RMS (@ sea level)  
**Current Rating:** 5 Amps  
**Contact Resistance:** 5 Milliohms maximum  
**Insulation Resistance:** 5000 Megohms minimum

## MECHANICAL

**Individual Contact Insertion and Separation Force:**  
16 oz. maximum with .070" (1.78mm) blade;  
1 oz. minimum with .054" (1.37mm) blade

Marketed exclusively through distribution.

**Edge Connector  
High Reliability**

.156" (3.96mm) Density  
Card Extender



**Dimensions**



**Dimensions**

| No. of<br>Pos./Cont. | A     |        | B     |        | C     |        | D     |        |
|----------------------|-------|--------|-------|--------|-------|--------|-------|--------|
|                      | in    | mm     | in    | mm     | in    | mm     | in    | mm     |
| 6/12                 | 1.100 | 27.94  | 1.239 | 31.47  | 1.531 | 38.88  | 1.785 | 45.33  |
| 10/20                | 1.724 | 43.79  | 1.864 | 47.34  | 2.156 | 54.76  | 2.410 | 61.21  |
| 12/24                | 2.036 | 51.71  | 2.177 | 55.29  | 2.469 | 62.71  | 2.723 | 69.16  |
| 15/30                | 2.504 | 63.60  | 2.645 | 67.18  | 2.937 | 74.59  | 3.191 | 81.05  |
| 18/36                | 2.972 | 75.48  | 3.114 | 79.09  | 3.406 | 86.51  | 3.660 | 92.96  |
| 22/44                | 3.596 | 91.33  | 3.739 | 94.97  | 4.031 | 102.38 | 4.285 | 108.83 |
| 25/50                | 4.067 | 103.30 | 4.208 | 106.88 | 4.500 | 114.30 | 4.754 | 120.75 |

**Ordering Information**

| No. of<br>Pos./Cont. | Catalog No. |
|----------------------|-------------|
| 6/12                 | 50-12S-30   |
| 10/20                | 50-20S-30   |
| 12/24                | 50-24S-30   |
| 15/30                | 50-30S-30   |
| 18/36                | 50-36S-30   |
| 22/44                | 50-44S-30   |
| 25/50                | 50-50S-30   |

Marketed exclusively through distribution.



### Card Guides

Card guide for .100" (2.54mm) and .156" (3.96mm) density edge connectors. Accepts .062" (1.59mm) thick PC boards. Card guides attach to mounting ears and guide printed circuit board into connector. Order separately.

**Material:** Polypropylene  
 Part No. 50-GP-1 (Green)  
 Part No. 50-GP-1B (Black)



### Polarizing Keys



Style A



Style B



Style C



Style D

| Description          | Connector Family | Material           | Style | Catalog No. |
|----------------------|------------------|--------------------|-------|-------------|
| Between-contact type | .156"            | Cellulose acetate  | B     | 50-PK       |
| In-contact type      | .156"            | Thermoset plastic  | B     | 50-PK1      |
| Between-contact type | .156"            | Glass epoxy        | A     | 50-PK2      |
| Between-contact type | .156"            | Glass epoxy        | D     | 50-PK2M     |
| Between-contact type | .100"            | Glass-filled nylon | C     | 50-PK3      |
| In-contact type      | .156"            | Thermoplastic      | B     | 50-PK4      |

Marketed exclusively through distribution.

**Plug Buttons**

Nickel-plated steel. Spring tension prongs.  
41V provides ventilation wherever required.



**Dimensions**

| For Hole Diameter |       | Cup Diameter |       | Catalog No. |
|-------------------|-------|--------------|-------|-------------|
| in                | mm    | in           | mm    |             |
| .250              | 6.35  | .406         | 10.32 | 41A         |
| .375              | 9.53  | .500         | 12.70 | 41B         |
| .500              | 12.70 | .656         | 16.67 | 41C         |
| .625              | 15.88 | .797         | 20.24 | 41D         |
| .750              | 19.05 | .938         | 23.81 | 41E         |
| .875              | 22.23 | 1.062        | 26.99 | 41F         |
| 1.000             | 25.40 | 1.156        | 29.37 | 41G         |
| 1.250             | 31.75 | 1.438        | 36.51 | 41H         |
| 1.000             | 25.40 | 1.156        | 29.37 | 41V         |

# Press-Fit BNC Coaxial Connector Board Mount Receptacle for 75 Ω Applications



## FEATURES

- **Solderless, Press-Fit Installation.**
- **Strong, One-Piece Cast Body.**
- **Standard BNC Interface.**
- **75Ω Impedance.**
- **Meets Lucent Technologies (AT&T) Requirements.**



**Compliant version,  
Pt. No. 299 99 00 134  
is also available.  
For more information please  
contact us at 1-800-323-9612**

## MATERIALS

**Body:** One-piece diecast zinc per QQ-Z-363  
**Plating:** Nickel, 150µin. min. per QQ-N-290 over copper, 200µin. min. per MIL-C-14550  
**Center Contact:** Beryllium copper  
**Plating:** Gold, 30µin. minimum over nickel, 50µin. minimum  
**Insulator:** Teflon TFE per ASTM D1710

## ELECTRICAL

|                               |                           |
|-------------------------------|---------------------------|
| <b>Impedance:</b>             | 75Ω                       |
| <b>Frequency Range:</b>       | 0 to 4 GHz                |
| <b>RF Leakage:</b>            | > -55 dB                  |
| <b>Insertion Loss:</b>        | .2dB maximum @ 2 GHz      |
| <b>VSWR:</b>                  | 1.024                     |
| <b>Working Voltage:</b>       | ≤ 500 VAC RMS @ sea level |
| <b>Insulation Resistance:</b> | ≥ 5000 MOhms @ 500 VDC    |

## MECHANICAL

**Connector Insertion Force:** ≤500 lb.\*  
**Connector Removal Force:** ≥100 lb.\*  
**Center Contact Insertion Force:** ≤ 2.0 lb.\*  
**Center Contact Removal Force:** ≥ 2.0 oz.\*  
 \*Requirements are for two connector insertions into the same PC board mounting holes. PC board thickness can range from .093" to .300" thick. PC board hole requirements are as follows:  
 Ground Legs: .059" Nom.  
 Center Contact: .040" Nom.

Unique patented press-fit connector design allows for multiple insertions into a backplane without loss of mechanical retention or electrical performance.

The design requirements for nominal PC board mounting holes and thickness are as follows:

Insertion Forces:

.093 Board Thickness: 200 lb. max.  
 .250 Board Thickness: 500 lb. max.

Withdraw Forces:

.093 Board Thickness: 100 lb. max.  
 .250 Board Thickness: 200 lb. max.

The Cinch Press-Fit BNC surpasses these requirements with a unique, non-symmetrical ground leg design. This design allows the connector to be inserted, removed, rotated 180°, and reinserted into the same location on the board without loss of mechanical or electrical performance.

# Press-Fit BNC Coaxial Connector Board Mount Receptacle for 75 Ω Applications



## Production Insertion Tool Design



## Press-Fit BNC Connector Dimensions



## Ordering Information

Catalog Number: BNC-1-PF  
 Standard Package: Anti-Static Tube, 48 Connectors Per Tube

# CYLINDRICAL

C48 Series/MIL-C-26500

Accessories & Application Tooling

Boeing: BACC45 / BACC63 Series



**Cinch**

FEATURES

- **Qualified to MIL-C-26500.**
- **Styles qualified to Boeing BACC45 Series.**
- **Styles qualified to Boeing BACC63 Series.**
- **Power Contact Sizes: 20, 16, and 12.**
- **Coax Contacts Available: Size 12 and 8.**
- **Contacts: Crimp - Front release.**
- **Optional Fixed Contacts: PC Termination.**
- **Coupling Styles: Bayonet and Threaded.**
- **Environmentally Sealed.**

MATERIALS

**Shell:** Aluminum, stainless-steel options available  
**Finish:** Aluminum - Anodize, optional electroless nickel / cadmium over nickel  
**Rubber:** Silicone / fluorosilicone  
**Dielectric:** Glass-filled epoxy

ENVIRONMENTAL

**Temperature Extremes:** +200°C / 392°F to -55°C / -65°F  
**Ozone Resistance:** 0.015% by volume  
**Temperature Life:** Internal 238°C for 1,000 hours  
**Moisture Resistance:** 1,000 megohms minimum / MIL-STD-202, Method 106  
**Thermal Shock:** -55°C (-67°F) to 260°C (500°F)

ELECTRICAL

**Dielectric Strength:** 1,500 volts VAC RMS  
**Current Rating (Test):** Size 20 7.5 Amps D.C.  
 Size 16 13.0 Amps D.C.  
 Size 12 23.0 Amps D.C.  
**Insulation Resistance:** 5,000 megohms minimum

MECHANICAL

**Contact Retention:** Size 20 - 20 lb. minimum  
 Size 16 - 25 lb. minimum  
 Size 12 - 30 lb. minimum  
**Durability:** Threaded - 200 mating cycles  
 Bayonet - 500 mating cycles  
**Vibration:** Std - 20 g's; 12 hours (Synasoidal)  
 MMB / Self-Lock - 39.6 g's RMS, 48 hours (Random)  
**Shock:** 50 g's

**GENERAL DESCRIPTION**

The C48 Series describes a family of connectors qualified to MIL-C-26500. While maintaining the MIL-C-26500 mating interface, this product has also been expanded to include qualifications to numerous Boeing specifications to satisfy general purpose requirements and unique product challenges for shielding, environmental sealing, fluid resistance, and vibration.



**Design Features**

- A. Positive Location Captivated Insert (Mechanical Interlock)
- B. Insert Face Seal
- C. Pin Contact, MIL-C-39029/31
- D. Contact Pressuring Seal
- E. Anti-Deflection Disc
- F. Resilient Pin Insert
- G. Insert Rim Seal
- H. Dynamic "O" Ring Shell Seal
- I. Five-Key Shell Polarization
- J. Metal-to-Metal Shoulder
- K. Bayonet or Threaded Coupling, Permanent Captivation
- L. Contact Retention Clip
- M. Socket Contact, MIL-C-39029/32
- N. Wire Sealing Risers
- O. Grommet

The expanded Cinch C48 product family offers numerous product options qualified to Boeing high-performance requirements and product solutions developed for alternate termination styles/low-profile packaging.

| <u>Product Description</u>   | <u>Cinch Series</u>                  |
|--|--------------------------------------|
| • Threaded non-decoupling design   | CN0966                               |
| • High-vibration bayonet plug with metal-to-metal bottoming shells   | C0909<br>CN1020                      |
| • Connectors for shell grounding / shielding effectiveness, non-rotating accessory teeth, and advanced fluid-resistance elastomers | CN0966<br>CN0967<br>CN1020<br>CN1021 |
| • Firewall Conformance   | CN0966<br>CN0967                     |
| • Low-profile connectors - crimp - removable contacts  | CN0915                               |
| • Low-profile connectors - fixed contacts / alternate termination styles   | CN0942<br>CN0944                     |

**Cinch Numbers**



**Military Standard Part Numbers**

You can use MS\* as well as C48 Series part numbers when ordering C48 Series connectors.

\*MS part numbers are supplied less cable support. If cable support is desired, it must be ordered separately.



Part numbers for the contacts and assembly tools are listed on page 3-12.



# C48 Series

## Inserts Available (Showing Front Face of Socket Inserts)



|   |                             |                             |
|---|-----------------------------|-----------------------------|
| <p><b>Shell Size-8</b></p>  | <p><b>Shell Size-10</b></p> | <p><b>Shell Size-12</b></p> |
| <p><b>Shell Size-14</b></p>   | <p><b>Shell Size-16</b></p> |                             |
| <p><b>Shell Size-18</b></p>   |                             |                             |
| <p><b>Shell Size-20</b></p>   |                             |                             |
| <p><b>Shell Size-22</b></p>   |                             |                             |
| <p><b>Shell Size-24</b></p>   |                             |                             |
| <p><b>Shell Size-28</b></p> <p><b>CN096X<br/>CN102X<br/>Series<br/>Only</b></p> |                             |                             |

**Alternate Shell Positions** (Front face of receptacle shown)

NOTE: Alternate positions 6 through Y incorporate special shell polarizing key and keyways. All inserts remain in the normal position.

| Positions  | For Connector Size 8 and 10 |      |      |      | For Connector Size 12, 14, 16, 18, 20, 22, 24, and 28 |      |      |      |
|------------|-----------------------------|------|------|------|---|------|------|------|
|            | A                           | B    | C    | D    | A   | B    | C    | D    |
| Normal (N) | 105°                        | 140° | 215° | 265° | 105°  | 140° | 215° | 265° |
| 6          | 102°                        | 132° | 248° | 320° | 18°   | 149° | 192° | 259° |
| 7          | 80°                         | 118° | 230° | 312° | 92°   | 152° | 222° | 342° |
| 8          | 35°                         | 140° | 205° | 275° | 84°   | 152° | 204° | 334° |
| 9          | 64°                         | 155° | 234° | 304° | 24°   | 135° | 199° | 240° |
| 10 or Y*   | 25°                         | 115° | 220° | 270° | 98°   | 152° | 268° | 338° |

\*Not available in Size 8 Connector. See individual part number systems.



† = #1 shielded contact is interchangeable with #12 power contact.  
(Y) = Available in Boeing Insert Style.

# C48 Series Plug Connectors



## Threaded Coupling

C48-06RXX-XXXX  
MS24266RXXTXXXX  
BACC45FS<sup>1</sup>



3

## Bayonet Coupling

C48-16RXX-XXXX  
MS24266RXXBXXXX  
BACC45FT<sup>1</sup>



## Dimensions

| Shell Size | A. Dia. |        | B. Dia. |        | C. Max. |        | D. Thread<br>UNEF-2A |
|------------|---------|--------|---------|--------|---------|--------|----------------------|
|            | in      | mm     | in      | mm     | in      | mm     |                      |
| 8          | .328    | 8.331  | .437    | 11.100 | .776    | 19.712 | .437-28              |
| 10         | .420    | 10.668 | .562    | 14.275 | .906    | 23.013 | .562-24              |
| 12         | .580    | 14.732 | .750    | 19.050 | 1.078   | 27.381 | .750-20              |
| 14         | .664    | 16.866 | .812    | 20.625 | 1.141   | 28.982 | .812-20              |
| 16         | .769    | 19.533 | .938    | 23.825 | 1.266   | 32.157 | .937-20              |
| 18         | .902    | 22.911 | 1.062   | 26.975 | 1.375   | 34.925 | 1.062-18             |
| 20         | 1.033   | 26.238 | 1.182   | 30.023 | 1.510   | 38.354 | 1.187-18             |
| 22         | 1.152   | 29.261 | 1.312   | 33.325 | 1.625   | 41.275 | 1.312-18             |
| 24         | 1.282   | 32.253 | 1.432   | 36.373 | 1.760   | 44.704 | 1.437-18             |

<sup>1</sup>Boeing Specifications, see page 3-14.

# C48 Series Receptacle Connectors



**Square Flange,  
Threaded Coupling**  
C48-OORXX-XXXX  
MS24264RXXTXXX  
BACC45FM<sup>1</sup>



**Square Flange,  
Bayonet Coupling**  
C48-1ORXX-XXXX  
MS24264RXXBXXX  
BACC45FN<sup>1</sup>



## Dimensions

| Shell<br>Size | A                  |                    | B                  |                    | C               |                 | D          |            | F          |            | G        | H        | J          |            | K          |            |
|---------------|--------------------|--------------------|--------------------|--------------------|-----------------|-----------------|------------|------------|------------|------------|----------|----------|------------|------------|------------|------------|
|               | ±.005 (.127)<br>in | ±.005 (.127)<br>mm | ±.005 (.127)<br>in | ±.005 (.127)<br>mm | Max. Dia.<br>in | Max. Dia.<br>mm | Max.<br>in | Max.<br>mm | Max.<br>in | Max.<br>mm | Thread   | Thread   | Min.<br>in | Min.<br>mm | Min.<br>in | Min.<br>mm |
| 8             | .812               | 20.625             | .594               | 15.088             | .125            | 3.175           | .561       | 14.250     | .437       | 11.100     | .562-24  | .437-28  | .620       | 15.748     | .447       | 11.354     |
| 10            | .937               | 23.800             | .719               | 18.263             | .125            | 3.175           | .696       | 17.679     | .562       | 14.275     | .687-24  | .562-24  | .748       | 18.999     | .572       | 14.529     |
| 12            | 1.031              | 26.188             | .812               | 20.625             | .125            | 3.175           | .875       | 22.225     | .750       | 19.050     | .875-20  | .750-20  | .913       | 23.190     | .760       | 19.304     |
| 14            | 1.125              | 28.575             | .906               | 23.013             | .125            | 3.175           | .935       | 23.749     | .812       | 20.625     | .937-20  | .812-20  | .980       | 24.892     | .822       | 20.879     |
| 16            | 1.250              | 31.750             | .969               | 24.613             | .125            | 3.175           | 1.062      | 26.975     | .938       | 23.825     | 1.062-18 | .937-20  | 1.107      | 28.119     | .948       | 24.079     |
| 18            | 1.343              | 34.112             | 1.062              | 26.975             | .125            | 3.175           | 1.187      | 30.150     | 1.062      | 26.975     | 1.187-18 | 1.062-18 | 1.209      | 30.709     | 1.072      | 27.229     |
| 20            | 1.437              | 36.500             | 1.156              | 29.363             | .125            | 3.175           | 1.312      | 33.325     | 1.182      | 30.023     | 1.312-18 | 1.187-18 | 1.337      | 33.960     | 1.192      | 30.277     |
| 22            | 1.562              | 39.675             | 1.250              | 31.750             | .125            | 3.175           | 1.437      | 36.500     | 1.312      | 33.325     | 1.437-18 | 1.312-18 | 1.452      | 36.881     | 1.322      | 33.579     |
| 24            | 1.703              | 43.256             | 1.375              | 34.925             | .154            | 3.912           | 1.562      | 39.675     | 1.432      | 36.373     | 1.562-18 | 1.437-18 | 1.577      | 40.056     | 1.442      | 36.627     |

<sup>1</sup> = Boeing specifications, see page 3-14.

# C48 Series Receptacle Connectors



**Single-Hole Mount,  
Threaded Coupling**  
C48-03RXX-XXXX  
MS24265RXXTXXX



3

**Single-Hole Mount,  
Bayonet Coupling**  
C48-13RXX-XXXX  
MS24265RXXBXXX



## Dimensions

| Shell<br>Size | A                  |        | B          |           | C                  |        | D          |        | E          |                 | G          |        | H        | J         | K        |
|---------------|--------------------|--------|------------|-----------|--------------------|--------|------------|--------|------------|-----------------|------------|--------|----------|-----------|----------|
|               | ±.005 (.127)<br>in | mm     | Max.<br>in | Hex<br>mm | ±.003 (.076)<br>in | mm     | Max.<br>in | mm     | Max.<br>in | Max. Dia.<br>mm | Max.<br>in | mm     | Thread   | Thread    | Thread   |
| 8             | .979               | 24.867 | .828       | 21.031    | .593               | 15.062 | 1.068      | 27.127 | .561       | 14.249          | .437       | 11.100 | .562-24  | .625-20*  | .437-28  |
| 10            | 1.104              | 28.042 | .953       | 24.206    | .718               | 18.237 | 1.192      | 30.277 | .696       | 17.678          | .562       | 14.275 | .687-24  | .750-20   | .562-24  |
| 12            | 1.291              | 32.791 | 1.140      | 28.956    | .905               | 22.987 | 1.380      | 35.052 | .875       | 22.225          | .750       | 19.050 | .875-20  | .937-20   | .750-20  |
| 14            | 1.391              | 35.331 | 1.250      | 31.750    | .968               | 24.587 | 1.505      | 38.227 | .935       | 23.749          | .812       | 20.625 | .937-20  | 1.000-20  | .812-20  |
| 16            | 1.516              | 38.506 | 1.329      | 33.757    | 1.093              | 27.762 | 1.630      | 41.402 | 1.062      | 26.975          | .938       | 23.825 | 1.062-18 | 1.125-20* | .937-20  |
| 18            | 1.641              | 41.681 | 1.455      | 36.957    | 1.217              | 30.912 | 1.740      | 44.196 | 1.187      | 30.150          | 1.062      | 26.975 | 1.187-18 | 1.250-20* | 1.062-18 |
| 20            | 1.766              | 44.856 | 1.642      | 41.707    | 1.342              | 34.087 | 1.860      | 47.244 | 1.312      | 33.325          | 1.182      | 30.023 | 1.312-18 | 1.375-18  | 1.187-18 |
| 22            | 1.954              | 49.632 | 1.705      | 43.307    | 1.467              | 37.262 | 2.040      | 51.816 | 1.437      | 36.500          | 1.312      | 33.325 | 1.437-18 | 1.500-20* | 1.312-18 |
| 24            | 2.079              | 52.807 | 1.892      | 48.057    | 1.592              | 40.437 | 2.160      | 54.864 | 1.562      | 39.675          | 1.432      | 36.373 | 1.562-18 | 1.625-18  | 1.437-18 |

\* Thread: UN-2A

## NOTES:

Contact factory for information about Boeing specifications.  
For mounting hole dimensions and jam nut torques, see page 3-20.

# C48/CN0915 Series Limited Wiring Space Receptacle Connectors Crimp Removal Contacts



Square-Flange,  
Threaded Coupling  
CN0915B-XXXXXXX-XXX



Square-Flange,  
Bayonet Coupling  
CN0915A-XXXXXXX-XXX



## Dimensions

| Shell Size | A             |        | B            |        | C            |       | D     |        | F             |        | G        |
|------------|---------------|--------|--------------|--------|--------------|-------|-------|--------|---------------|--------|----------|
|            | ±.0045 (.114) |        | ±.005 (.127) |        | ±.004 (.102) |       | Max.  |        | ±.0015 (.038) |        | Thread   |
|            | in            | mm     | in           | mm     | in           | mm    | in    | mm     | in            | mm     | UNEF-2A  |
| 8          | .812          | 20.625 | .594         | 15.088 | .121         | 3.073 | .561  | 14.250 | .497          | 12.624 | .562-24  |
| 10         | .937          | 23.800 | .719         | 18.263 | .121         | 3.073 | .696  | 17.679 | .503          | 15.799 | .687-24  |
| 12         | 1.031         | 26.187 | .812         | 20.625 | .121         | 3.073 | .875  | 22.225 | .745          | 18.923 | .875-20  |
| 14         | 1.125         | 28.575 | .906         | 23.012 | .121         | 3.073 | .935  | 23.749 | .871          | 22.123 | .937-20  |
| 16         | 1.150         | 29.210 | .969         | 24.613 | .121         | 3.073 | 1.062 | 26.975 | .995          | 25.273 | 1.062-18 |
| 18         | 1.343         | 35.382 | 1.062        | 26.975 | .121         | 3.073 | 1.187 | 30.150 | 1.058         | 26.873 | 1.187-18 |
| 20         | 1.437         | 36.500 | 1.156        | 29.362 | .121         | 3.073 | 1.312 | 33.325 | 1.184         | 30.074 | 1.312-18 |
| 22         | 1.562         | 39.675 | 1.250        | 31.750 | .121         | 3.073 | 1.437 | 36.500 | 1.307         | 33.198 | 1.437-18 |
| 24         | 1.703         | 43.256 | 1.375        | 34.925 | .154         | 3.912 | 1.562 | 39.675 | 1.432         | 36.373 | 1.562-18 |

## Ordering Information<sup>1</sup>



## NOTES:

- <sup>1</sup> For other modifications, classes, etc., contact factory.
- For mounting hole dimensions, see page 3-20.
- Uses CRIM-LOK contacts. See page 3-12.
- \* Former order code - 100 designated rhodium plated contacts

# CN0942/CN0944 Series (C48 Family)

## Short Receptacle Connectors

### Non-Removable Contacts



Single-Hole Mount,  
Bayonet Coupling  
CN0942D XXXXXXXXX  
CN0944D XXXXXXXXX



Square Flange,  
Bayonet Coupling  
CN0942B XXXXXXXXX  
CN0944B XXXXXXXXX



### Dimensions

| Shell Size | A Max. |        | B Max. |        | C Max. |        | D Max. |        | F Thread  | J ±.005 (.127) |        | K ±.005 (.127) |        | L ±.003 (.176) |        |
|------------|--------|--------|--------|--------|--------|--------|--------|--------|-----------|----------------|--------|----------------|--------|----------------|--------|
|            | in     | mm     | in     | mm     | in     | mm     | in     | mm     |           | in             | mm     | in             | mm     | in             | mm     |
| 8          | .984   | 24.994 | .828   | 21.031 | 1.068  | 27.127 | .561   | 14.250 | .625-20*  | .812           | 20.625 | .594           | 15.088 | .593           | 15.062 |
| 10         | 1.109  | 28.169 | .953   | 24.206 | 1.192  | 30.277 | .696   | 17.679 | .750-20   | .937           | 23.800 | .719           | 18.263 | .718           | 18.237 |
| 12         | 1.296  | 32.919 | 1.140  | 28.956 | 1.380  | 35.052 | .875   | 22.225 | .937-20   | 1.031          | 26.188 | .812           | 20.625 | .905           | 22.987 |
| 14         | 1.396  | 35.459 | 1.250  | 31.750 | 1.505  | 38.227 | .935   | 23.749 | 1.000-20  | 1.125          | 28.575 | .906           | 23.013 | .968           | 24.587 |
| 16         | 1.521  | 38.634 | 1.329  | 33.757 | 1.630  | 41.402 | 1.062  | 26.975 | 1.125-20* | 1.250          | 31.750 | .969           | 24.613 | 1.093          | 27.762 |
| 18         | 1.646  | 41.809 | 1.455  | 36.957 | 1.740  | 44.196 | 1.187  | 30.150 | 1.250-20* | 1.343          | 34.112 | 1.062          | 26.975 | 1.217          | 30.912 |
| 20         | 1.771  | 44.984 | 1.642  | 41.707 | 1.860  | 47.244 | 1.312  | 33.325 | 1.375-18  | 1.437          | 36.500 | 1.156          | 29.363 | 1.342          | 34.087 |
| 22         | 1.959  | 49.759 | 1.705  | 43.307 | 2.040  | 51.816 | 1.437  | 36.500 | 1.500-20* | 1.562          | 39.675 | 1.250          | 31.750 | 1.467          | 37.262 |
| 24         | 2.084  | 52.934 | 1.892  | 48.057 | 2.160  | 54.864 | 1.562  | 39.675 | 1.625-18  | 1.703          | 43.256 | 1.375          | 34.925 | 1.592          | 40.437 |

\* Th'd: UN-2A

\*\* See "S" and "T" dimensions on page 3-10.

# CN0942/CN0944 Series (C48 Family)

## Short Receptacle Connectors

### Non-Removable Contacts



#### CN0942 Series: Fluorosilicone Inserts

#### Ordering Information<sup>1</sup>

| Termination Designator | Contact Style | Termination T Min. | Termination S ± .002 |
|------------------------|---------------|--------------------|----------------------|
| 01*                    | P & S         | .250               | .025                 |
| 02*                    | X & Y         | .230               | N/A                  |
| 03**                   | P & S         | .144               | .025                 |
| 04**                   | X & Y         | .124               | N/A                  |
| 06*                    | T & W         | .900               | .025                 |

\* Applies to CN0942B/CN0942C.  
 \*\* Applies to CN0942D/CN0942E.



#### NOTES:

<sup>1</sup> For other modifications, class, etc., consult factory.  
 For mounting hole dimensions, see page 3-20.

#### CN0944 Series: Neoprene Inserts

#### Ordering Information<sup>1</sup>

| Termination Designator | Term Type | Termination T Min. | Termination S ± .002 |
|------------------------|-----------|--------------------|----------------------|
| 01*                    | B         | .250               | .025                 |
| 02*                    | C         | .230               | N/A                  |
| 03**                   | B         | .144               | .025                 |
| 04**                   | C         | .124               | N/A                  |
| 06*                    | W         | .900               | .025                 |

\* Applies to CN0944B/CN0944C.  
 \*\* Applies to CN0944D/CN0944E.



#### NOTES:

<sup>1</sup> For other modifications, class, etc., consult factory.  
 For mounting hole dimensions, see page 3-20.



## Cable Support Assembly

Cable clamps support cable or wire at the plug or receptacle and prevent twisting and pulling.



## Dimensions

| Size | Cinch Part No. | MS         | A               |        | B                       |        | X                               |        | C Th'd<br>UNEF-2B | P          |        |
|------|----------------|------------|-----------------|--------|-------------------------|--------|---------------------------------|--------|-------------------|------------|--------|
|      |                |            | Max. Dia.<br>in | mm     | $\pm .015$ (.381)<br>in | mm     | I.D.<br>$\pm .005$ (.127)<br>in | mm     |                   | Max.<br>in | mm     |
| 8    | C48-2840       | MS27291-13 | .606            | 15.393 | .935                    | 23.749 | .186                            | 4.725  | .437-28           | .789       | 20.042 |
| 10   | C48-2341       | MS27291-1  | .731            | 18.568 | .935                    | 23.749 | .270                            | 6.858  | .562-24           | .914       | 23.216 |
| 12   | C48-2342       | MS27291-2  | .919            | 23.343 | .935                    | 23.749 | .400                            | 10.160 | .750-20           | 1.026      | 26.061 |
| 14   | C48-2343       | MS27291-3  | .981            | 24.918 | 1.170                   | 29.718 | .460                            | 11.684 | .812-20           | 1.090      | 27.686 |
| 16   | C48-2344       | MS27291-4  | 1.106           | 28.093 | 1.170                   | 29.718 | .610                            | 15.494 | .937-20           | 1.250      | 31.750 |
| 18   | C48-2345       | MS27291-5  | 1.231           | 31.268 | 1.170                   | 29.718 | .690                            | 17.526 | 1.062-18          | 1.358      | 34.493 |
| 20   | C48-2643       | MS27291-14 | 1.356           | 34.443 | 1.170                   | 29.718 | .816                            | 20.728 | 1.187-18          | 1.481      | 37.619 |
| 22   | C48-2346       | MS27291-6  | 1.481           | 37.618 | 1.170                   | 29.718 | .940                            | 23.876 | 1.312-18          | 1.604      | 40.742 |
| 24   | C48-2644       | MS27291-15 | 1.606           | 40.793 | 1.170                   | 29.178 | 1.066                           | 27.078 | 1.437-18          | 1.729      | 43.919 |



### Contacts

When you order Cinch C48 Series connectors with contacts, the contact package contains enough contacts to complete the insert arrangement plus two spares. The package also includes sealing plugs for 15% of the contacts in the inserts, minimum of three. To provide proper sealing, insert unwired contacts and sealing plugs in all unused holes. (Use a #12 contact for a #1 shielded hole.) To order contacts and sealing plugs separately use the part numbers in the table below.

| Contact Size         | Max. Wire Size AWG | Current Rating Amps | Cinch Part No. |             | MS Part No.   |               |
|----------------------|--------------------|---------------------|----------------|-------------|---------------|---------------|
|                      |                    |                     | Pin            | Socket      | Pin           | Socket        |
| No. 20               | 24                 | 3.0                 |                |             |               |               |
|                      | 22                 | 5.0                 | CN0900-253     | CN0900-255  | M39029/31-241 | M39029/32-260 |
|                      | 20                 | 7.5                 |                |             |               |               |
| No. 16               | 18                 | 16                  |                |             |               |               |
|                      | 16                 | 22                  | CN0900-252     | CN0900-254  | M39029/31-229 | M39029/32-248 |
|                      | 14                 | 32                  |                |             |               |               |
| No. 12               | 12                 | 41                  | CN0900-256     | CN0900-257  | M32029/31-235 | M39029/32-254 |
|                      | **                 | 3                   | C48-1226-02    | C48-1227-02 | --            | --            |
| No. 1*<br>(Shielded) | ****               | 1                   | C48-1226-54    | C48-1227-54 | --            | --            |
|                      | *****              | 1                   | C48-1226-55    | C48-1227-55 | --            | --            |
| No. 2<br>(Shielded)  | ***                | 7.5                 | C48-2187-02    | C48-2188-02 | --            | --            |

\* Fits into No. 12 power contact cavity.

\*\* Accommodates cables RG174/U, RG179U, RG179A/U, RG187/U, RG188/U, RG161/U, as well as shielded wire.

Can also accommodate Cable MIL-C-27500-22 KING (Extruded) or 22 AWG per MIL-C-7078 type II.

\*\*\* Accommodates Cable MIL-C-27500 KING; 20 KING; 18 KING (Extruded) or 22, 20, 18 AWG, per MIL-C-7078 type II.

\*\*\*\* For use with RG195/U and RG180/U, RG180A/U, and RG1808/U.

\*\*\*\*\* Accommodates Cables RG178/U, RG178A/U, RG1788/U, and RG196/U.

### Grommet Sealing Plugs

| Color Code | Size             | Cinch Part No. | MS Part No. |
|------------|------------------|----------------|-------------|
| Yellow     | 12 & #1 Shielded | C48-2221-12    | MS27488-12  |
| Blue       | 16               | C48-2221-16    | MS27488-16  |
| Red        | 20               | C48-2221-20    | MS27488-20  |
| White      | #2 Shielded      | C48-1458-01    | --          |

### Tools

| Contact Size             | Crimp Tool  | Insertion Tool |              | Removal Tool   |              |
|--------------------------|-------------|----------------|--------------|----------------|--------------|
|                          |             | Superseded No. | Current No.  | Superseded No. | Current No.  |
| No. 20                   | M22520/1-01 | MS24256A20     | M81969/17-03 | MS24256R20     | M81969/19-06 |
| No. 16                   | M22520/1-01 | MS24256A16     | M81969/17-04 | MS24256R16     | M81969/19-01 |
| No. 12                   | M22520/1-01 | MS24256A12     | M81969/17-05 | MS24256R12     | M81969/19-02 |
| <b>Adjustable Turret</b> |             |                |              |                |              |
| No. 20                   | M22520/1-02 |                |              |                |              |
| No. 16                   | M22520/1-02 |                |              |                |              |
| No. 12                   | M22520/1-02 |                |              |                |              |
| No. 1<br>(Shielded)      |             | MS24256A12     | M81969/17-05 | MS24256R12     | M81969/19-09 |
| No. 2<br>(Shielded)      |             | --             | 294-128      | --             | 294-127      |

- *Cinch has qualified a series of connectors to Boeing Specifications in bayonet and threaded styles that meet high-performance requirements for:*

- + Vibration*
- + Shielding Effectiveness*
- + Fluid Resistance*

**BACC63 Series**

|  | <u>BN</u> | <u>BP</u> | <u>BV</u> | <u>CB</u> | <u>CC</u> |
|--|-----------|-----------|-----------|-----------|-----------|
| ■ <i>Vibration-resistant Bayonet Plug</i>                  | ●         |           |           | ●         |           |
| ■ <i>Vibration-resistant Self-Locking threaded Plug</i>    |           | ●         |           |           |           |
| ■ <i>Optional Ground Spring on Plug</i>                    |           | ●         |           | ●         |           |
| ■ <i>Shielded Connectors</i>                               |           | ●         | ●         | ●         | ●         |
| ■ <i>Advanced fluid-resistant elastometers</i>             |           | ●         | ●         | ●         | ●         |
| ■ <i>Non-rotating accessory teeth conforming to MS3155</i> |           | ●         | ●         | ●         | ●         |
| ■ <i>Optional Stainless Steel Shells</i>                   |           | ●         | ●         |           |           |

## BOEING TO Cinch CROSS-REFERENCE DATA

Cinch Part Numbers and Order Codes  
For Applicable Purchase Order Exceptions, see Note 6.

| Boeing Part Numbers   | No Exceptions      | Less Contacts | Less Contacts & Cable Support | Less Cable Support |
|-----------------------|--------------------|---------------|-------------------------------|--------------------|
| BACC45FM**-*P6        | C48-00R**Y**P-402  | -406          | -406                          | -402               |
| See Note 2 A P6       | See Note 3 P6-410  | -415          | -416                          | -412               |
| B P7                  | P7-420             | -425          | -426                          | -422               |
| See Note 5 C P8       | P8-430             | -435          | -436                          | -432               |
| D P9                  | P9-440             | -445          | -446                          | -442               |
| E P10                 | P10-450            | -455          | -456                          | -452               |
| BACC45FN**-*P6        | C48-10R**Y**P6-402 | -406          | -406                          | -402               |
| BACC45FS**-*P6        | C48-06R**Y**P6-402 | -406          | -406                          | -402               |
| BACC45FT**-*P6        | C48-16R**Y**P6-402 | -406          | -402                          | -406               |
| <b>(BACC63 Types)</b> |                    |               |                               |                    |
| BACC63BN**-*P6        | C0909A**-*P6Y402   | Y406          | Y406                          | Y402               |
| See Note 5 B          | See Note 3 Y420    | Y425          | Y426                          | Y422               |
| C                     | Y430               | Y435          | Y436                          | Y432               |
| BACC63BP**A**P6       | CN0966A**A**P6Y140 | Y040          | N/A                           | N/A                |
| B                     | A**S**P6Y140       | Y040          | N/A                           | N/A                |
| See Note 7 C          | B**G**P6Y140       | Y040          | N/A                           | N/A                |
| D                     | B**S**P6Y140       | Y040          | N/A                           | N/A                |
| BACC63BV**A**P6       | CN0967C**A**P6Y140 | Y040          | N/A                           | N/A                |
| B                     | S**P6Y140          | Y040          | N/A                           | N/A                |
| F                     | G**P6Y140          | Y040          | N/A                           | N/A                |
| BACC63CB**-*P6        | CN1020A**G**P6Y140 | Y040          | N/A                           | N/A                |
| BACC63CC**-*P6        | CN1021A**G**P6Y140 | Y040          | N/A                           | N/A                |

See Note 4

### NOTES:

- All parts are marked with Boeing part number.
  - Part number system also applies to BACC45FN, BACC45FS, and BACC45FT.
  - May be "Y" or "-" (dash) designator  
 "Y" = Insert arrangements with size 20 contacts (see page 3-4) use small wire grommet seals, Boeing insert discs, and hard socket inserts.  
 "-" = Insert arrangements that contain no size 20 contact locations. Use standard "MS" grommets, discs, and inserts.
  - "P6" represents contact style and shell polarities defined in individual part numbering systems.
  - Specifies optional cable support:  
 "-" = No cable support  
 "A" = BACC10GH Straight Single-Leg Clamp  
 "B" = MS27559 Right-Angle Saddle Clamp  
 "C" = MS27291 Straight Saddle Clamp  
 "D" = BACC10JC Right-Angle Single Leg Clamp  
 "E" = BACC10JS Straight Single-Leg Composite Clamp
  - The Boeing specifications permit omission of contacts and/or cable support through purchase order exceptions.
  - Specifies material and shell designs. See Boeing specification.
- \*\* These part number fields represent shell size and insert arrangement as defined in individual part number systems.

# CN0966 Series (C48 Family) Self-Locking Plug Connectors



## Threaded Coupling

CN0966XXXXXXXXX

BACC63BP<sup>1</sup>



# 3

## Dimensions

| Shell Size | A<br>± .005 (.127) |        | B<br>Max. Dia. |        | C<br>Thread<br>UNEF-2A |
|------------|--------------------|--------|----------------|--------|------------------------|
|            | in                 | mm     | in             | mm     |                        |
| 8          | .835               | 21.209 | .306           | 7.773  | .500-20                |
| 10         | .972               | 23.698 | .371           | 9.423  | .625-24                |
| 12         | 1.165              | 27.254 | .547           | 13.894 | .750-20                |
| 14         | 1.230              | 30.124 | .613           | 15.570 | .875-20                |
| 16         | 1.355              | 33.198 | .758           | 19.253 | 1.000-20               |
| 18         | 1.470              | 34.798 | .865           | 21.971 | 1.0625-18              |
| 20         | 1.607              | 38.100 | .986           | 25.044 | 1.1875-18              |
| 22         | 1.735              | 41.148 | 1.106          | 28.092 | 1.3125-18              |
| 24         | 1.858              | 44.069 | 1.235          | 31.369 | 1.4375-18              |
| 28         | 2.113              | 52.070 | 1.485          | 37.719 | 1.750-18*              |

## Ordering Information<sup>2</sup>

**CN0966 B 10 S 05 P N - 000**

### Series Designation

CN0966

### Series Modification

A - Ungrounded

B - Grounded (Conductive)

### Shell Size

8, 10, 12, 14, 16, 18, 20, 22, 24, 26, 28

### Class

A - Anodized Aluminum

G - Cadmium/Nickel-Plated Aluminum

K - Stainless Steel Flame Resistant

N - Electroless Nickel-Plated Aluminum

S - Stainless Steel

### Order Code (Deviations)<sup>1</sup>

000 - Less Contacts

100 - \* See below

200 - With Gold-Plated Contacts

### Alternate Shell Positions

N, 6, 7, 8, 9, 10

Per table on page 3-4

### Contact Style

P - Pin Insert

S - Socket Insert

### Insert Arrangements

(See page 3-4)

## Notes:

<sup>1</sup> For Boeing Specification, see page 3-14.

<sup>2</sup> For modifications, classes, etc. not listed, consult factory.

\* Th'd: UNS-2A

\*\* Size 28 = 1.395 (35.434)

\* Former order code - 100 designated rhodium plated contacts

# CN0967 (C48 Series) Vibration-Resistant Receptacle



**Threaded Coupling**  
CN0967XXXXXXXXX  
BACC63BV<sup>1</sup>



## Dimensions

| Shell Size | A                    |                      | B                   |                     | C          |            | D               |                 | J                 | L                 |
|------------|----------------------|----------------------|---------------------|---------------------|------------|------------|-----------------|-----------------|-------------------|-------------------|
|            | +0.0045 (.114)<br>in | +0.0045 (.114)<br>mm | +0.005 (.127)<br>in | +0.005 (.127)<br>mm | Max.<br>in | Max.<br>mm | Max. Dia.<br>in | Max. Dia.<br>mm | Thread<br>UNEF-2A | Thread<br>UNEF-2A |
| 8          | .812                 | 20.625               | .594                | 15.088              | .561       | 14.250     | .328            | 8.331           | .5265-24          | .5000-20          |
| 10         | .937                 | 23.800               | .719                | 18.263              | .696       | 14.250     | .371            | 9.423           | .6875-24          | .6250-24          |
| 12         | 1.031                | 26.187               | .812                | 20.625              | .875       | 17.679     | .547            | 13.894          | .8750-20          | .7500-20          |
| 14         | 1.125                | 28.575               | .906                | 23.012              | .935       | 22.225     | .609            | 15.469          | .9375-20          | .8750-20          |
| 16         | 1.250                | 31.750               | .969                | 24.613              | 1.062      | 23.749     | .758            | 19.253          | 1.0625-18         | 1.0000-20         |
| 18         | 1.343                | 34.112               | 1.062               | 26.975              | 1.187      | 30.150     | .865            | 21.971          | 1.1875-18         | 1.0625-18         |
| 20         | 1.437                | 36.500               | 1.156               | 29.362              | 1.312      | 33.325     | .986            | 25.044          | 1.3125-18         | 1.1875-18         |
| 22         | 1.562                | 39.675               | 1.250               | 31.750              | 1.437      | 36.500     | 1.106           | 28.092          | 1.4375-18         | 1.3125-18         |
| 24         | 1.703                | 43.256               | 1.375               | 34.925              | 1.562      | 39.675     | 1.235           | 31.369          | 1.5625-18         | 1.4375-18         |
| 28         | 2.000                | 50.800               | 1.562               | 39.675              | 1.810      | 45.976     | 1.485           | 37.719          | 1.8125-16         | 1.750-18*         |

## Ordering Information<sup>2</sup>



## NOTES:

- <sup>1</sup> For Boeing Specification, see page 3-14.
  - <sup>2</sup> For modifications, classes, etc., not listed, consult factory.
- For mounting hole dimensions, see page 3-20.
  - \* Th'd: UNS-2A
  - \*\*Size 28 = 1.457 (37.008)
  - \* Former order code - 100 designated rhodium plated contacts

# CN1020 Series (C48 Family) Vibration-Proof Plug Connector



**Bayonet Coupling**  
CN1020-XXXXXXXX  
BACC63CB<sup>1</sup>



## Dimensions

| Shell Size | A             |        | B         |        | C         |
|------------|---------------|--------|-----------|--------|-----------|
|            | + .005 (.127) |        | Max. Dia. |        | Thread    |
|            | in            | mm     | in        | mm     | UNEF-2A   |
| 8          | .765          | 19.447 | .306      | 7.773  | .500-20   |
| 10         | .967          | 24.561 | .371      | 9.423  | .625-24   |
| 12         | 1.078         | 27.381 | .547      | 13.894 | .750-20   |
| 14         | 1.187         | 30.149 | .613      | 15.570 | .875-20   |
| 16         | 1.309         | 33.248 | .758      | 19.253 | 1.000-20  |
| 18         | 1.375         | 34.925 | .865      | 21.971 | 1.0625-18 |
| 20         | 1.505         | 38.227 | .986      | 25.044 | 1.1875-18 |
| 22         | 1.625         | 41.275 | 1.106     | 28.092 | 1.3125-18 |
| 24         | 1.755         | 44.577 | 1.235     | 31.369 | 1.4375-18 |
| 28         | 2.161         | 54.889 | 1.485     | 37.719 | 1.750-18* |

## Ordering Information<sup>2</sup>



### Notes:

- <sup>1</sup> For Boeing Specification, see page 3-14.
- <sup>2</sup> For modification, classes, etc., not listed, consult factory.
- \* Th'd: UNS-2A
- \*\* Size 28 = 1.395 (35.434)
- \* Former order code - 100 designated rhodium plated contacts

# CN1021 Series (C48 Family) Vibration-Resistant Receptacle



**Bayonet Coupling**  
CN1021XXXXXXXXX  
BACC63CC<sup>1</sup>



## Dimensions

| Shell Size | A<br>+.0045 (.114) |        | B<br>+.005 (.127) |        | C<br>Max. |        | D<br>Max. Dia. |        | L<br>Thread<br>UNEF-2A |
|------------|--------------------|--------|-------------------|--------|-----------|--------|----------------|--------|------------------------|
|            | in                 | mm     | in                | mm     | in        | mm     | in             | mm     |                        |
| 8          | .812               | 20.625 | .594              | 15.088 | .561      | 14.250 | .328           | 8.331  | .500-20                |
| 10         | .937               | 23.800 | .719              | 18.263 | .696      | 14.250 | .371           | 9.423  | .625-24                |
| 12         | 1.031              | 26.187 | .812              | 20.625 | .875      | 17.679 | .547           | 13.894 | .750-20                |
| 14         | 1.125              | 28.575 | .906              | 23.012 | .935      | 22.225 | .609           | 15.469 | .875-20                |
| 16         | 1.250              | 31.750 | .969              | 24.613 | 1.062     | 23.749 | .758           | 19.253 | 1.000-20               |
| 18         | 1.343              | 34.112 | 1.062             | 26.975 | 1.187     | 30.150 | .865           | 21.971 | 1.0625-18              |
| 20         | 1.437              | 36.500 | 1.156             | 29.362 | 1.312     | 33.325 | .986           | 25.044 | 1.1875-18              |
| 22         | 1.562              | 39.675 | 1.250             | 31.750 | 1.437     | 36.500 | 1.106          | 28.092 | 1.3125-18              |
| 24         | 1.703              | 43.256 | 1.375             | 34.925 | 1.562     | 39.675 | 1.235          | 31.369 | 1.4375-18              |
| 28         | 2.000              | 50.800 | 1.562             | 39.675 | 1.810     | 45.976 | 1.485          | 37.719 | 1.750-18*              |

## Ordering Information<sup>2</sup>



### Notes:

- <sup>1</sup> For Boeing Specification, see page 3-14.
- <sup>2</sup> For modifications, classes, etc. not listed, consult factory.
- For mounting hole dimensions, see page 3-20.
- \* Th'd: UNS-2A
- \*\* Size 28 = 1.457 (37.008)
- \* Former order code - 100 designated rhodium plated contacts

# C0909A MMB Series (C48 Family) Vibration-Proof Plug Connector



## Bayonet Coupling

C0909AXXXXXXX

BACC63BN<sup>1</sup>



3

## Dimensions

| Shell Size | A Dia. |        | B Dia. |        | C Max. |        | D Thread<br>UNEF-2A |
|------------|--------|--------|--------|--------|--------|--------|---------------------|
|            | in     | mm     | in     | mm     | in     | mm     |                     |
| 8          | .328   | 8.331  | .437   | 11.100 | .766   | 19.456 | .437-28             |
| 10         | .420   | 10.668 | .562   | 14.275 | .906   | 23.012 | .562-24             |
| 12         | .580   | 14.732 | .750   | 19.050 | 1.078  | 27.381 | .750-20             |
| 14         | .664   | 16.866 | .812   | 20.625 | 1.141  | 28.981 | .812-20             |
| 16         | .769   | 19.533 | .938   | 23.825 | 1.266  | 32.156 | .937-20             |
| 18         | .902   | 22.911 | 1.062  | 26.975 | 1.375  | 34.925 | 1.062-18            |
| 20         | 1.033  | 26.238 | 1.182  | 30.023 | 1.510  | 38.354 | 1.187-18            |
| 22         | 1.152  | 29.261 | 1.312  | 33.325 | 1.625  | 41.275 | 1.312-18            |
| 24         | 1.282  | 32.253 | 1.432  | 36.373 | 1.760  | 44.704 | 1.437-18            |

## Ordering Information<sup>2</sup>



### Notes:

<sup>1</sup> For Boeing Specification, see page 3-14.

<sup>2</sup> For deviations, classes, etc. not listed, consult factory.

\* Former order code - 102 designated rhodium plated contacts



# C48 Series & C48 Family Mounting Panel Data



## Square-Flange Mount



## Single-Hole Mount (Jam-Nut Mount)



## Dimensions

| Shell Size | M Min. |        | N Min. |        | G ±.005 (.127) |        | H ±.005 (.127) |        | K ±.005 (.127) |        |
|------------|--------|--------|--------|--------|----------------|--------|----------------|--------|----------------|--------|
|            | in     | mm     | in     | mm     | in             | mm     | in             | mm     | in             | mm     |
| 8          | .620   | 15.748 | .447   | 11.354 | .605           | 15.638 | .635           | 16.129 | .594           | 15.088 |
| 10         | .748   | 18.999 | .572   | 14.529 | .730           | 18.542 | .760           | 19.304 | .719           | 18.263 |
| 12         | .913   | 23.190 | .760   | 19.304 | .917           | 23.292 | .947           | 24.054 | .812           | 20.625 |
| 14         | .980   | 24.892 | .822   | 20.879 | .980           | 24.892 | 1.010          | 25.654 | .906           | 23.013 |
| 16         | 1.107  | 28.119 | .948   | 24.079 | 1.105          | 28.067 | 1.135          | 28.829 | .969           | 24.613 |
| 18         | 1.209  | 30.709 | 1.072  | 27.229 | 1.225          | 31.115 | 1.260          | 32.004 | 1.062          | 26.975 |
| 20         | 1.337  | 33.906 | 1.192  | 30.277 | 1.350          | 34.290 | 1.385          | 35.179 | 1.156          | 29.363 |
| 22         | 1.452  | 36.881 | 1.322  | 33.579 | 1.475          | 37.465 | 1.510          | 38.354 | 1.250          | 31.750 |
| 24         | 1.577  | 40.056 | 1.442  | 36.627 | 1.600          | 40.640 | 1.635          | 41.529 | 1.375          | 34.925 |
| 28         | 1.827  | 46.406 | 1.760  | 44.704 | 1.856          | 47.143 | 1.885          | 47.879 | 1.562          | 39.675 |

## Recommended Minimum Torque for Jam Nut

| Shell Size        | 8  | 10 | 12 | 14   | 16 | 18 | 20  | 22    | 24  |
|-------------------|----|----|----|------|----|----|-----|-------|-----|
| Torque (Inch/lb.) | 28 | 36 | 56 | 64.5 | 69 | 81 | 102 | 122.5 | 144 |

# D-SUBMINIATURE

D\*KL Series

D\*A Series

D\*U Series

Basic D Series

Series 3 - High Reliability

Backshells/Junctionshells/Hoods

Application Tooling

HTD/HPD Series

Overmold Kits

T\* Series

Series 1 - High Reliability

M24308 Series

Accessories



**Cinch**

The D-subminiature is one of the most popular styles of connectors in the I/O category. It is used in computer, telecom, datacom, medical, and test instrumentation applications as well as in the military and aerospace fields.

**Types of D-subminiature connectors manufactured by Cinch**

- Printed Circuit Board connectors:
  - Vertical connectors for panel mounting with Dip Solder PC tails.
  - Right-Angle connectors for board mounting with Dip Solder PC tails.
- Wire Termination connectors for cable assemblies or wire harnesses:
  - Crimp and Poke connectors.
  - Solder Cup connectors.
  - Insulation Displacement connectors IDCs to terminate discrete wire or flat cable.
  - Wire Wrap connectors.

**How to read this section**

- The information pages provide standard data common to all D-subminiature connectors. These include:
  - D-subminiature contact arrangements - see page 4-5.
  - Panel mounting specifications/hardware - see page 4-6.
  - D-subminiature shell dimensions - see page 4-7.
  - D-subminiature and combo D layouts - see pages 4-5, 4-8 thru 4-10, and 4-56.
  - General Performance Specifications - see page 4-2.
  - PCB thickness chart - see page 4-8.
- D-subminiature pages are grouped by series. A series is a family of connectors with a similar performance level. Each series shares a set of features and specifications, from economical and commercial grade product to high-reliability and military connectors. Each series begins with a page outlining general features and specifications of connectors, followed by the pages on individual connectors with drawings or features specific to that connector. Drawings reflect clarifications of dimensions not called out in the information pages of this catalog. The features of each series can be found in the chart on page 4-4.
- Accessories including backshells, junction shells, and hoods as well as hardware can be found on pages 4-80 thru 4-99.
- Termination tooling for Cinch connectors can be found at the end of the D-subminiature section of this catalog on pages 4-100 thru 4-104.

**General Information**

- All connectors are intermateable with any Cinch D-subminiature of comparable pin count and density, or the D-sub connector of any other manufacturer complying dimensionally with MIL-C-24308.
- Solder terminations and boardlocks meet the requirements for solderability in accordance with MIL-STD-202, Method 208.
- DURABILITY
  - Mated connectors are subjected to cycles of insertions and withdrawals specified on the catalog page. After the prescribed cycles the connectors will meet the Cinch requirements concerning insertion-withdrawal force, individual contact insertion-withdrawal force, and contact resistance.
- APPROVALS
  - Most Cinch connectors have UL recognition and CSA approval; however, the specific approvals are listed on the individual catalog pages.
- CONTACTS
  - Cinch connector contacts are generally offered in Gold Flash or 30µin. gold plating for commercial product, and 50µin. gold plating for M24308 Series Military D-subminiature connectors.
  - Cinch connectors utilize economical stamped and formed contacts and/or screw machine contacts for enhanced performance.
  - Standard density connectors utilize size 20 contacts.
  - Cinch 1.5 Density Series connectors utilize size 22 contacts for greater density in a standard size D-subminiature outer shell.
- METAL SHELLS
  - Commercial-grade steel shells are usually available in zinc plating with yellow chromate finish or tin plating.
  - Tin-plated plugs have grounding indents.
  - Military grade M24308 Series connector shells are generally steel or in certain cases non-magnetic brass with cadmium plating and yellow chromate finish.
  - Insulator materials are glass-filled polyester, glass-filled nylon, and diallyl phthalate.
- The connectors are usually available in plugs and sockets in 9, 15, 25, 37, and 50 position sizes.

**Printed Circuit Board Connectors**

- Cinch provides connectors in various footprints, contact diameters, and lengths in both vertical and right-angle PC mount styles with dip solder tails.
- Cinch PCB connectors have metal shells.

**Connectors for Terminating Cable Wire**

- Wire Wrap connectors are available in two tail lengths for two-wrap and three-wrap terminations. The contact is terminated by wrapping wire around it using a wire wrap gun. This connector is especially useful for prototyping since the wire can be unwrapped and rewrapped if necessary.
- Solder Cup connectors allow reliable long-term termination by soldering the wire directly into the connector contact. Cinch Solder Cups accommodate up to 20 AWG wire.
- Crimp and Poke connectors allow the wire to be terminated more economically than wire wrap or solder cup styles. Contacts are crimped and inserted into the connector. In our D\*U Series, the contact is crimped around the conductor wire. In our D\*A Series, the contact is crimped around the wire and the insulation. Crimp and Poke connectors can be selectively loaded to save labor and material cost.
- IDC connectors are an alternative to other types of wire termination connectors. IDC is much faster and very reliable when all contacts are terminated and the volume is high. IDC utilizes mass termination of the cable wire. This can save considerable time and expense in the cable assembly process. The estimated time of terminating two ends of a 25-conductor discrete wire cable with 25-position D-subminiature connectors is about 5-1/2 to 6 minutes less per cable assembly using IDC connectors and Cinch Auto-Clinch termination tooling versus using Crimp and Poke connectors. This may vary considerably based on the operator, cable wire, and process. Cinch offers IDC connectors in two versions-for discrete wire or flat ribbon termination.

**Feature Guide**

The chart below contains Cinch D-subminiature product features and styles grouped by series.

| Performance Level          | Economical |         | Commercial |      |      |         | High-Reliability |          | Military |
|----------------------------|------------|---------|------------|------|------|---------|------------------|----------|----------|
| Series                     | D*KL       | HPD/HTD | D*A        | D*U  | T    | Basic D | Series 1         | Series 3 | M24308   |
| <b>Termination Type</b>    |            |         |            |      |      |         |                  |          |          |
| Vertical PCB               | 4-12       |         |            |      | 4-26 | 4-42    |                  | 4-50     | 4-76     |
| Right-Angle PCB            | 4-12       | 4-16    |            |      | 4-26 |         |                  | 4-50     | 4-76     |
| Crimp and Poke             |            | 4-16    | 4-20       | 4-26 |      |         |                  | 4-72     | 4-76     |
| Solder Cup                 |            |         |            |      | 4-34 | 4-42    |                  | 4-50     | 4-76     |
| IDC                        |            |         |            |      | 4-34 |         |                  |          |          |
| Wire Wrap                  |            |         |            |      |      | 4-42    |                  |          |          |
| <b>Insulator Material</b>  |            |         |            |      |      |         |                  |          |          |
| G-F Nylon                  |            |         | •          | •    |      |         |                  |          |          |
| G-F Polyester              | •          | •       |            |      | •    | •       |                  |          |          |
| Diallyl Phthalate          |            |         |            |      |      |         | •                | •        | •        |
| <b>Shell Material</b>      |            |         |            |      |      |         |                  |          |          |
| All Plastic                |            |         |            |      | •    |         |                  |          |          |
| Steel Shell                | •          | •       | •          | •    | •    | •       | •                | •        | •        |
| <b>Shell Plating</b>       |            |         |            |      |      |         |                  |          |          |
| Tin-Lead Plating           | •          | •       | •          | •    | •    | •       | •                | •        |          |
| Zinc Plating-Y/C finish    |            |         | •          | •    | •    | •       | •                | •        |          |
| Cadmium Plating-Y/C finish |            |         |            |      |      |         | •*               | •        | •        |
| <b>Contact Plating</b>     |            |         |            |      |      |         |                  |          |          |
| Gold-Flash Plating         | •          | •       | •          | •    | •    | •       |                  |          |          |
| 30µin. Gold Plating        | •          | •       | •          | •    | •    | •       | •                | •        |          |
| 50µin. Gold Plating        |            |         |            |      |      |         | •*               | •        | •        |
| <b>Contact Type</b>        |            |         |            |      |      |         |                  |          |          |
| Stamped Contacts           | •          | •       | •          | •    | •    | •       |                  |          |          |
| Machined Contacts          |            |         |            | •    |      | •       | •                | •        | •        |

Accessories information starts on page 4-80.  
Tooling information starts on page 4-100.

\* Applies to Combination Layout Only.



**Standard Density Plug Inserts**



Shell Size E  
(9 Position)



Shell Size A  
(15 Position)



Shell Size B  
(25 Position)



Shell Size C  
(37 Position)



Shell Size D  
(50 Position)

**1.5 Density Plug Inserts**



Shell Size E  
(15 Position)



Shell Size A  
(26 Position)



Shell Size B  
(44 Position)



Shell Size C  
(62 Position)

NOTE: Mating face of plug is shown; socket is mirror image.

**Panel Mounting Specifications**



**Dimensions**

| Shell Size | Positions | Mounting Method   |  | A    |       | B    |       | C    |       | D    |       | E    |       | F    |      | H    |      |
|------------|-----------|-------------------|--|------|-------|------|-------|------|-------|------|-------|------|-------|------|------|------|------|
|            |           | Front/ Rear Panel |  | in   | mm    | in   | mm    | in   | mm    | in   | mm    | in   | mm    | in   | mm   | in   | mm   |
| E          | 9         | Front             |  | 0.98 | 24.89 | 0.49 | 12.45 | 0.87 | 22.10 | 0.44 | 11.18 | 0.51 | 12.95 | 0.26 | 6.60 | 0.08 | 2.03 |
|            |           | Rear              |  | 0.98 | 24.89 | 0.49 | 12.45 | 0.81 | 20.57 | 0.40 | 10.16 | 0.45 | 11.43 | 0.23 | 5.84 | 0.13 | 3.30 |
| A          | 15        | Front             |  | 1.31 | 33.27 | 0.66 | 16.76 | 1.10 | 27.94 | 0.60 | 15.24 | 0.51 | 12.95 | 0.26 | 6.60 | 0.08 | 2.03 |
|            |           | Rear              |  | 1.31 | 33.27 | 0.66 | 16.76 | 1.13 | 28.70 | 0.57 | 14.48 | 0.45 | 11.43 | 0.23 | 5.84 | 0.13 | 3.30 |
| B          | 25        | Front             |  | 1.85 | 46.99 | 0.93 | 23.62 | 1.74 | 44.20 | 0.87 | 22.10 | 0.51 | 12.95 | 0.26 | 6.60 | 0.08 | 2.03 |
|            |           | Rear              |  | 1.85 | 46.99 | 0.93 | 23.62 | 1.67 | 42.42 | 0.84 | 21.34 | 0.45 | 11.43 | 0.23 | 5.84 | 0.13 | 3.30 |
| C          | 37        | Front             |  | 2.50 | 63.50 | 1.25 | 31.75 | 2.39 | 60.71 | 1.20 | 30.48 | 0.51 | 12.95 | 0.26 | 6.60 | 0.08 | 2.03 |
|            |           | Rear              |  | 2.50 | 63.50 | 1.25 | 31.75 | 2.33 | 59.18 | 1.16 | 29.46 | 0.45 | 11.43 | 0.23 | 5.84 | 0.13 | 3.30 |
| D          | 50        | Front             |  | 2.41 | 61.21 | 1.20 | 30.48 | 2.30 | 58.42 | 1.15 | 29.21 | 0.62 | 15.75 | 0.31 | 6.60 | 0.08 | 2.03 |
|            |           | Rear              |  | 2.41 | 61.21 | 1.20 | 30.48 | 2.22 | 56.39 | 1.11 | 28.19 | 0.56 | 14.22 | 0.28 | 5.84 | 0.13 | 3.30 |

4

**PANEL MOUNTING HARDWARE: Aids in alignment of plug and receptacle.**

**Float Bushing**



Rear panel mounting

**Reverse Float Bushing**



Front panel mounting

**Floating Dual Bushing**



Front and rear panel mounting

**4-40 Clinch Nut**



Rear panel mounting





| Shell Size | Positions | Connector Type | A ±.015" (0.38mm) |       | B ±.010" (0.25mm) |       | B <sub>1</sub> ±.005" (0.13 mm) |       | C ±.005" (0.13mm) |       | D ±.010" (0.25mm) |       | D <sub>1</sub> ±.010" (0.25mm) |       | E ±.010" (0.25mm) |       |
|------------|-----------|----------------|-------------------|-------|-------------------|-------|---------------------------------|-------|-------------------|-------|-------------------|-------|--------------------------------|-------|-------------------|-------|
|            |           |                | in                | mm    | in                | mm    | in                              | mm    | in                | mm    | in                | mm    | in                             | mm    | in                | mm    |
| E          | 9         | Plug           | 1.213             | 30.81 | --                | --    | .666                            | 16.90 | 0.984             | 24.99 | --                | --    | .329                           | 8.40  | .494              | 12.55 |
|            |           | Socket         | 1.213             | 30.81 | .640              | 16.26 | --                              | --    | 0.984             | 24.99 | .308              | 7.82  | --                             | --    | .494              | 12.55 |
| A          | 15        | Plug           | 1.541             | 39.14 | --                | ---   | .994                            | 25.30 | 1.312             | 33.32 | --                | ---   | .329                           | 8.40  | .494              | 12.55 |
|            |           | Socket         | 1.541             | 39.14 | .968              | 24.59 | --                              | --    | 1.312             | 33.32 | .308              | 7.82  | --                             | --    | .494              | 12.55 |
| B          | 25        | Plug           | 2.088             | 53.04 | --                | --    | 1.534                           | 39.00 | 1.852             | 47.04 | --                | --    | .329                           | 8.40  | .494              | 12.55 |
|            |           | Socket         | 2.088             | 53.04 | 1.508             | 38.30 | --                              | --    | 1.852             | 47.04 | .308              | 7.82  | --                             | --    | .494              | 12.55 |
| C          | 37        | Plug           | 2.729             | 69.32 | --                | ---   | 2.182                           | 55.40 | 2.500             | 63.50 | --                | ---   | .329                           | 8.40  | .494              | 12.55 |
|            |           | Socket         | 2.729             | 69.32 | 2.156             | 54.76 | --                              | --    | 2.500             | 63.50 | .308              | 7.82  | --                             | ---   | .494              | 12.55 |
| D          | 50        | Plug           | 2.635             | 66.93 | --                | --    | 2.079                           | 52.80 | 2.406             | 61.11 | --                | --    | .436                           | 11.07 | .605              | 15.37 |
|            |           | Socket         | 2.635             | 66.93 | 2.062             | 52.34 | --                              | --    | 2.406             | 61.11 | .420              | 10.67 | --                             | --    | .605              | 15.37 |

| Shell Size | Positions | Connector Type | G ±.010" (0.25mm) |       | H ±.010" (0.25mm) |       | J ±.010" (0.25 mm) |      | K ±.005" (0.25mm) |      | L ±.010" (0.25mm) |      | M ±.010" (0.25mm) |       |
|------------|-----------|----------------|-------------------|-------|-------------------|-------|--------------------|------|-------------------|------|-------------------|------|-------------------|-------|
|            |           |                | in                | mm    | in                | mm    | in                 | mm   | in                | mm   | in                | mm   | in                | mm    |
| E          | 9         | Plug           | .759              | 19.28 | .422              | 10.72 | .030               | 0.76 | .236              | 5.99 | .045              | 1.14 | .422              | 10.72 |
|            |           | Socket         | .759              | 19.28 | .422              | 10.72 | .030               | 0.76 | .243              | 6.17 | .045              | 1.14 | .429              | 10.92 |
| A          | 15        | Plug           | 1.083             | 27.51 | .422              | 10.72 | .030               | 0.76 | .236              | 5.99 | .045              | 1.14 | .422              | 10.72 |
|            |           | Socket         | 1.083             | 27.51 | .422              | 10.72 | .030               | 0.76 | .253              | 6.17 | .045              | 1.14 | .429              | 10.92 |
| B          | 25        | Plug           | 1.625             | 41.27 | .422              | 10.72 | .039               | 0.99 | .231              | 5.87 | .060              | 1.52 | .426              | 10.82 |
|            |           | Socket         | 1.625             | 41.27 | .422              | 10.72 | .030               | 0.76 | .243              | 6.17 | .045              | 1.14 | .429              | 10.92 |
| C          | 37        | Plug           | 2.272             | 57.71 | .422              | 10.72 | .039               | 0.99 | .231              | 5.87 | .060              | 1.52 | .426              | 10.82 |
|            |           | Socket         | 2.272             | 57.71 | .422              | 10.72 | .030               | 0.76 | .243              | 6.17 | .045              | 1.14 | .429              | 10.92 |
| D          | 50        | Plug           | 2.178             | 55.32 | .534              | 13.56 | .039               | 0.99 | .231              | 5.87 | .060              | 1.52 | .426              | 10.82 |
|            |           | Socket         | 2.178             | 55.32 | .534              | 13.56 | .030               | 0.76 | .243              | 6.17 | .045              | 1.14 | .429              | 10.92 |

B and D are outside dimensions for socket. D and B are inside dimensions for plug.

**Standard Density D-subminiature  
Mounting Dimensions Board Layouts  
Footprints (Component side shown)**

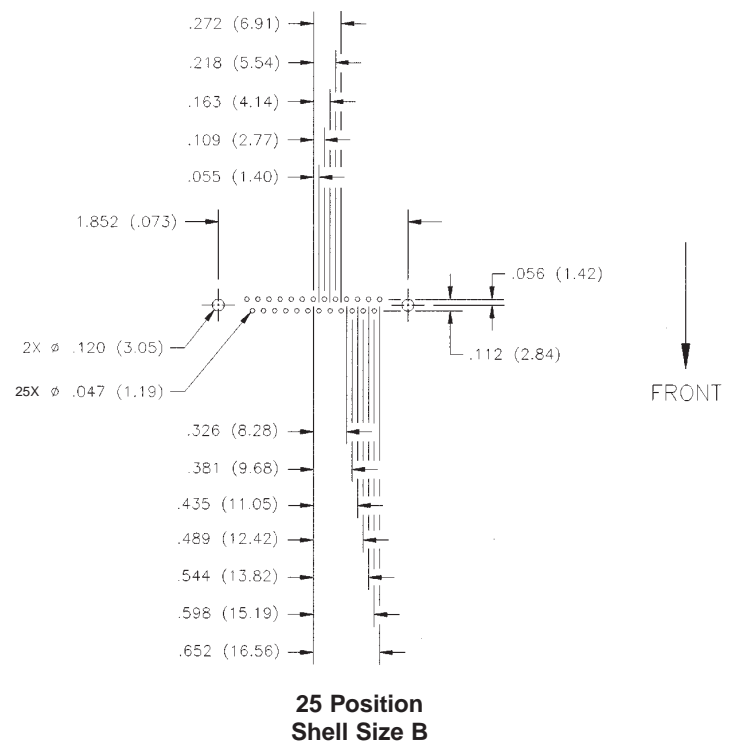
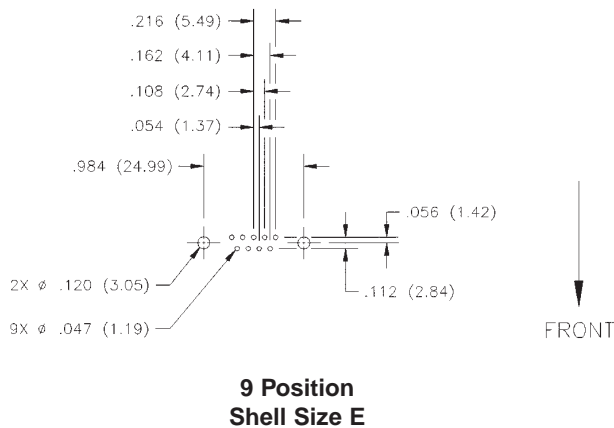

The footprints on this page are standard for all metal shell D-subminiature connectors.

On all right-angle D-subminiature connectors, the short row of contacts is positioned closest to the edge of the board.

**PC Board Lead Hole Size**

| Terminal Dia. |           | Hole Dia. |      |
|---------------|-----------|-----------|------|
| in            | mm        | in        | mm   |
| .040          | 1.02      | .055      | 1.40 |
| .030          | 0.76      | .045      | 1.14 |
| .024-.025     | 0.61-0.64 | .039      | 0.99 |

**Standard Density D-subminiature  
Mounting Dimensions Board Layouts  
Footprints (Component side shown)**



The footprints on this page are standard for all metal shell D-subminiature connectors.

On all right-angle D-subminiature connectors, the short row of contacts is positioned closest to the edge of the board.

**PC Board Lead Hole Size**

| Terminal Dia. |           | Hole Dia. |      |
|---------------|-----------|-----------|------|
| in            | mm        | in        | mm   |
| .040          | 1.02      | .055      | 1.40 |
| .030          | 0.76      | .045      | 1.14 |
| .024-.025     | 0.61-0.64 | .039      | 0.99 |

**1.5 Density D-subminiature  
Recommended PCB Layout for  
Footprint (Component side shown)**

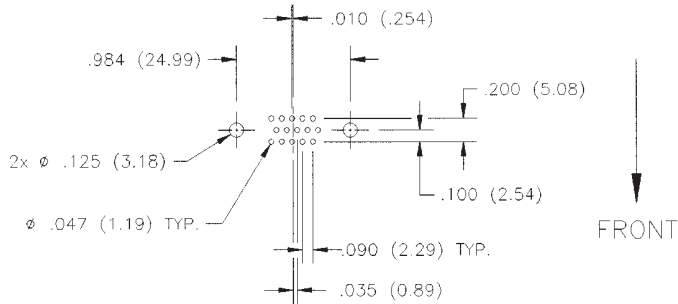

**15 Position  
Shell Size E**



**44 Position  
Shell Size B**



**26 Position  
Shell Size A**

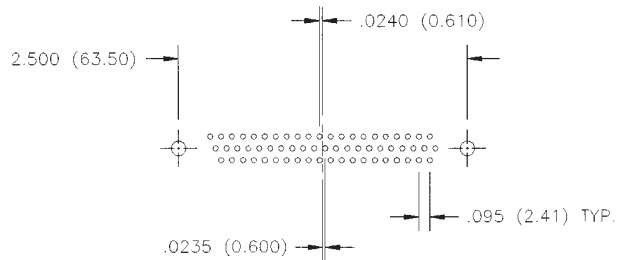

**62 Position  
Shell Size C**

4

The footprints on this page are standard for all metal shell D-subminiature connectors.

On all right-angle D-subminiature connectors, the short row of contacts is positioned closest to the edge of the board.

**PC Board Lead Hole Size**

| Terminal Dia. |           | Hole Dia. |      |
|---------------|-----------|-----------|------|
| in            | mm        | in        | mm   |
| .040          | 1.02      | .055      | 1.40 |
| .030          | 0.76      | .045      | 1.14 |
| .024-.025     | 0.61-0.64 | .039      | 0.99 |

# D-subminiature Metal Shell Right-Angle and Vertical PCB D\*KL Series



## FEATURES

- Offered in right-angle or vertical PCB mount versions.
- Available with gold flash or 30µin. gold plating.
- Metal Shell provides grounding and shielding capability.
- Approvals:
  - UL Recognized: File E130965.
  - CSA Approved: File LR97981.
- See pages 4-5 thru 4-10 for standard dimensions, contact arrangements, and panel mounting specifications.

## MATERIALS

**Insulator Material:** Glass-filled polyester (black), UL 94V-O rated  
**Contact Material:** Socket - Phosphor bronze (stamped)  
 Plug - Brass (stamped)  
**Contact Plating:** Gold flash or 30µin. gold in mating area and tin/lead on tails. All over nickel.  
**Metal Shell:** Steel with tin plating (grounding indents on plug)



## ENVIRONMENTAL

**Operating Temperature:** -55°C to +125°C  
**Shock:** 50G peak per MIL-STD-202, Method 213, Condition G  
**Vibration:** 12 cycles in three perpendicular directions @ 10-2000Hz, per MIL-STD-202, Method 204, Condition D  
**Moisture Resistance:** 90-95% relative humidity @ 40°C for 96 hours per MIL-STD-202, Method 103



## ELECTRICAL

**Withstanding Voltage:** Right Angle - minimum AC 1250V RMS @ sea level, Vertical - minimum AC 1000V RMS @ sea level  
**Current Rating:** 5 Amps  
**Contact Resistance:** 15 milliohms maximum  
**Insulation Resistance:** 5000 megohms maximum (initial); 1000 megohms (minimum) after environmental testing



## MECHANICAL

**Individual Contact Insertion and Separation Force (minimum/maximum):** 0.7 oz./12 oz.  
**Durability:** 500 mating cycles



# Economical D-subminiature Metal Shell Right-Angle PCB D\*KL Series



## Right-Angle Connectors

- 0.318" footprint.
- Available in 9, 15, and 25 position plugs and sockets.
- Offered with 4-40 threaded inserts for secure mounting to panels or with female screwlocks.
- Boardlocks to provide mechanical hold-down during wave soldering process.
- **Materials:**
  - Boardlock: Brass with tin plating.
  - Female Screwlock: Brass with nickel plating.



## Ordering Information

### Right-Angle Plugs

| Size | 4-40 Threaded Inserts |                | Female Screwlocks |                |
|------|-----------------------|----------------|-------------------|----------------|
|      | Gold Flash            | 30µin. Gold    | Gold Flash        | 30µin. Gold    |
| 9    | DEKL-9PATI-E          | DEKL-9PATI-E2  | DEKL-9PATI-F      | DEKL-9PATI-F2  |
| 15   | DAKL-15PATI-E         | DAKL-15PATI-E2 | DAKL-15PATI-F     | DAKL-15PATI-F2 |
| 25   | DBKL-25PATI-E         | DBKL-25PATI-E2 | DBKL-25PATI-F     | DBKL-25PATI-F2 |

### Right-Angle Sockets

| Size | 4-40 Threaded Inserts |               | Female Screwlocks |               |
|------|-----------------------|---------------|-------------------|---------------|
|      | Gold Flash            | 30µin. Gold   | Gold Flash        | 30µin. Gold   |
| 9    | DEKL-9SAT-E           | DEKL-9SAT-E2  | DEKL-9SAT-F       | DEKL-9SAT-F2  |
| 15   | DAKL-15SAT-E          | DAKL-15SAT-E2 | DAKL-15SAT-F      | DAKL-15SAT-F2 |
| 25   | DBKL-25SAT-E          | DBKL-25SAT-E2 | DBKL-25SAT-F      | DBKL-25SAT-F2 |

**D-subminiature Metal Shell  
Vertical PCB  
D\*KL Series**



**Vertical Connectors:**

- Available in 9, 15, 25, 37, and 50 position plugs and sockets with straight dip solder tails.
- 0.024" contact diameter.
- Offered with standard mounting holes.



**Ordering Information**

4

**Vertical PCB Connectors**

| Size | Plugs       |               | Sockets    |              |
|------|-------------|---------------|------------|--------------|
|      | Gold Flash  | 30µin. Gold   | Gold Flash | 30µin. Gold  |
| 9    | DEKL-9PUTI  | DEKL-9PUTI-2  | DEKL-9SUT  | DEKL-9SUT-2  |
| 15   | DAKL-15PUTI | DAKL-15PUTI-2 | DAKL-15SUT | DAKL-15SUT-2 |
| 25   | DBKL-25PUTI | DBKL-25PUTI-2 | DBKL-25SUT | DBKL-25SUT-2 |
| 37   | DCKL-37PUTI | DCKL-37PUTI-2 | DCKL-37SUT | DCKL-37SUT-2 |
| 50   | DDKL-50PUTI | DDKL-50PUTI-2 | DDKL-50SUT | DDKL-50SUT-2 |

# D-subminiature 1.5 Density Metal Shell Crimp and Poke and Right-Angle PCB HPD/HTD Series



## FEATURES

- **1.5 Density means the connector uses small size #22 contacts for a higher pin count in a standard size shell. Also accepts standard D-subminiature accessories (hoods, backshells, etc.) per the following chart:**

| <u>Shell Size</u> | <u>1.5 D-sub<br/>No. of Pins</u> | <u>Standard D-sub<br/>No. of Pins</u> |
|-------------------|----------------------------------|---------------------------------------|
| <i>E</i>          | <b>15</b>                        | <b>9</b>                              |
| <i>A</i>          | <b>26</b>                        | <b>15</b>                             |
| <i>B</i>          | <b>44</b>                        | <b>25</b>                             |
| <i>C</i>          | <b>62</b>                        | <b>37</b>                             |

- **Offered in cable plugs and right-angle PCB mount sockets.**
- **Metal Shell provides grounding and shielding capability.**
- **Approvals:**
  - Plugs:* • **UL Recognized - Files E170218 (UL1977) & E130965 (UL1863).**
  - **CSA Approved - File LR31996-7.**
  - Sockets:* **UL Recognized - File E170218.**
- **See pages 4-5 thru 4-10 for standard dimensions, contact arrangements, and panel mounting specifications.**

## MATERIALS

**Connector Shell:** Steel with tin plating (grounding indents on plug)

**Contact Material:** Phosphor bronze (stamped)

**Contact Plating:**

- **Sockets:** Gold flash or 30µin. gold in mating area and tin/lead on tails. All over nickel.
- **Plugs:** Gold flash or 30µin. gold in mating area and gold flash on remainder. All over nickel.



## ENVIRONMENTAL

**Operating Temperature:** -55°C to +125°C

**Shock:** 50G peak per MIL-STD-202, Method 213, Condition G

**Vibration:** 12 cycles in three perpendicular directions @10-2000Hz, per MIL-STD-202, Method 204, Condition D

**Moisture Resistance:** 90-95% relative humidity @ 40°C for 96 hours per MIL-STD-202, Method 103



## ELECTRICAL

**Withstanding Voltage:** Minimum 1000V RMS @ sea level

**Current Rating:** 3 Amps

**Contact Resistance:** 15 milliohms maximum

**Insulation Resistance:** 5000 megohms maximum (initial); 1000 megohms (minimum) after environmental testing



## MECHANICAL

**Individual Contact Insertion and**

**Separation Force (minimum/maximum):** 0.7 oz./12 oz.

**Durability:**

- **Plugs** - 200 mating cycles
- **Sockets** - 200 mating cycles





# D-subminiature 1.5 Density Metal Shell Crimp and Poke Plugs HTD Series



## Connectors:

- Offered with .120 mounting holes.
- Shells offered with tin plating and grounding indents.
- These connectors are designed to accommodate one repair cycle.

## Contacts: (Not included with connectors, order separately)

- Available with gold-flash plating or 30µin. gold.
- Crimp and Poke versions are offered in reels of 15,000 or 300 contacts.
- Solder and Poke contacts are packed loose.
- Will accommodate 22-30 AWG wire.
- Order contacts separately. See page 4-18.

## Termination Tooling:

- Semi-automatic Stripper Crimper Tool for 15,000 reels: #HTD-518. See page 4-102.
- Crimp Contact Hand Tool for 300-piece reels: #HTD-266. See page 4-101.
- Semi-automatic Hand Crimping Tool for individual contact termination: #HTD-544. See page 4-101.
- Contact Insertion/Extraction Tool: Cinch #CIET-22-DF. See page 4-101.

## Materials:

- Insulator Material: Black UL 94 V-0 glass-filled nylon.



## Ordering Information

### HTD Series 1.5 Density Crimp and Poke Plug Connectors

| Size | Shell Size | Catalog Number |
|------|------------|----------------|
| 15   | E          | HTDE-15PTI-FO  |
| 26   | A          | HTDA-26PTI-FO  |
| 44   | B          | HTDB-44PTI-FO  |
| 62   | C          | HTDC-62PTI-FO  |

# D-subminiature 1.5 Density Metal Shell Crimp and Poke Plugs HTD Series



- Use with HTD Series 1.5 D-Sub Crimp and Poke connectors and overmold kits.
- All Crimp and Poke contacts are on right-hand feed reels.



**Crimp and Poke Plug Contact**



**Solder and Poke Plug**

4

## Ordering Information

### HTD Series 1.5 D-sub Male Crimp and Poke and Solder and Poke Contacts

| Type of Packing | Crimp and Poke<br>15,000 Reel |                | Crimp and Poke<br>300 Reel |              | Solder and Poke<br>Loose |               |
|-----------------|-------------------------------|----------------|----------------------------|--------------|--------------------------|---------------|
| Plating         | Gold Flash                    | 30µin. Gold    | Gold Flash                 | 30µin. Gold  | Gold Flash               | 30µin. Gold   |
| Pin             | HTD-CP-9-15000                | HTD-CP-1-15000 | HTD-CP-9-300               | HTD-CP-1-300 | HTD-SP-9-10              | Not Available |

# D-subminiature 1.5 Density Metal Shell Right-Angle PCB Sockets HPD Series



- .350" footprint.
- Offered with fixed 4-40 threaded inserts for secure mounting to panels or with assembled female screwlocks.
- Boardlocks to maintain electrical continuity between shell and PC board ground and provide mechanical hold-down during wave soldering process.
- Available in standard configuration sockets, sizes 15, 26, 44, and 62 with black insulator.
- 15 position socket also available with royal blue insulator in Windows '95® configuration with Pin #9 recessed 0.050".

## Materials:

- Insulator Material: Glass-filled polyester (standard configuration - black, -9R configuration - blue), UL 94V-0 rated.
- Boardlock: Brass with tin plating.
- Female Screwlock: Brass with Nickel plating.



## Dimensions

| Positions | A                 |                     | B                 |                    | C                 |                    | D     |      |
|-----------|-------------------|---------------------|-------------------|--------------------|-------------------|--------------------|-------|------|
|           | $\pm 0.015$<br>in | $(\pm 0.038)$<br>mm | $\pm 0.010$<br>in | $(\pm 0.25)$<br>mm | $\pm 0.010$<br>in | $(\pm 0.25)$<br>mm | in    | mm   |
| 15        | 1.214             | 30.84               | 0.984             | 24.99              | 0.640             | 16.26              | 0.090 | 2.29 |
| 26        | 1.545             | 39.24               | 1.312             | 33.32              | 0.967             | 24.56              | 0.090 | 2.29 |
| 44        | 2.088             | 53.04               | 1.852             | 47.04              | 1.508             | 38.30              | 0.090 | 2.29 |
| 62        | 2.730             | 69.34               | 2.500             | 63.50              | 2.156             | 54.76              | 0.095 | 2.41 |

## Ordering Information

### HPD Series 1.5 Density Right-Angle Socket Connectors

| Size | Shell |              |       | 4-40 Threaded Inserts |                   | Female Screwlocks |                   |
|------|-------|--------------|-------|-----------------------|-------------------|-------------------|-------------------|
|      | Size  | Type         | Color | Gold Flash            | 30µin. Gold       | Gold Flash        | 30µin. Gold       |
| 15   | E     | Standard     | Black | HPDEB-15SAT-E         | HPDEB-15SAT-E2    | HPDEB-15SAT-F     | HPDEB-15SAT-F2    |
| 26   | A     | Standard     | Black | HPDAB-26SAT-E         | HPDAB-26SAT-E2    | HPDAB-26SAT-F     | HPDAB-26SAT-F2    |
| 44   | B     | Standard     | Black | HPDBB-44SAT-E         | HPDBB-44SAT-E2    | HPDBB-44SAT-F     | HPDBB-44SAT-F2    |
| 62   | C     | Standard     | Black | HPDCB-62SAT-E         | HPDCB-62SAT-E2    | HPDCB-62SAT-F     | HPDCB-62SAT-F2    |
| 15   | E     | Windows '95® | Blue  | HPDEB-15SAT-E-9R      | HPDEB-15SAT-E2-9R | HPDEB-15SAT-F-9R  | HPDEB-15SAT-F2-9R |

Windows '95 is a registered trademark of Microsoft.

# D-subminiature Metal Shell Crimp and Poke D\*A Series



## FEATURES

- Offered in 9, 15, 25, 37, and 50 position plugs and sockets.
- Contacts:
  - Available with gold flash or 30µin. gold plating.
  - Offered in 15,000 contact reel or 300 contact reel, or in loose-piece bags of 100 or 1000 each.
  - Accommodate 20-24 AWG wire or 26-30 AWG wire.
  - Not included with connector - order stamped contacts separately.
- Approvals:
  - UL Recognized - Files E170218 (UL1977) and E130965 (UL1863).
  - CSA Approved - File LR31996.
- See pages 4-5 thru 4-10 for standard dimensions, contact arrangements, and panel mounting specifications.

## MATERIALS

**Insulator Material:** Glass-filled nylon (black), UL 94 V-O rated  
**Connector Shell:** Steel with zinc plating and yellow chromate finish or tin plating (plug has grounding indents)  
**Contact Material:**

- Plug - Brass (stamped)
- Socket - Phosphor bronze (stamped)

**Contact Plating:** Gold flash or 30µin. gold in mating area and gold flash on the remainder. All over nickel.  
**4-40 Clinch Nut:** Steel with cadmium plating and yellow chromate finish  
**Dual Float Bushing:** Stainless steel, passivated



## ENVIRONMENTAL

**Operating Temperature:** -65°C to + 125°C  
**Shock:** 50G peak per MIL-STD-202, Method 213, Condition G  
**Vibration:** 12 cycles in three perpendicular directions @ 10-2000Hz, per MIL-STD-202, Method 204, Condition D  
**Moisture Resistance:** 90-95% relative humidity @ 40°C for 96 hours per MIL-STD-202, Method 103

## ELECTRICAL

**Withstanding Voltage:** Minimum 1000V RMS @ sea level  
**Current Rating:** 5 Amps  
**Contact Resistance:** 2.7 milliohms maximum  
**Insulation Resistance:** 5000 megohms maximum (initial); 1000 megohms (minimum) after environmental testing

## MECHANICAL

**Individual Contact Insertion and Separation Force (minimum/maximum):** 0.7 oz./12 oz.  
**Durability:** 500 mating cycles

# D-subminiature Metal Shell Crimp and Poke Connectors D\*A Series



- Offered with .120 mounting holes or 4-40 clinch nuts.



## Termination Tools

- Semi-Automatic Stripper Crimper Tool for 15K reels: #GSC-20-30. See page 4-102.
- Contact Insertion/Extraction Tool: #CIET-20-HDB. See page 4-101.
- Crimp Contact Hand Tool for 300-piece reels: #GHC-B (20-26 AWG wire) or Catalog #GHC-B1 (28-30 AWG wire). See page 4-101.
- Crimp Contact Hand Tool for loose piece contacts: #HTD-544. See page 4-101.

## Ordering Information

### D\*A Series Crimp and Poke Connectors - Plugs

| Positions | Zinc-plated shell with yellow chromate finish |                  | Tin-plated shell with grounding indents |                  |
|-----------|---|------------------|---|------------------|
|           | Mounting Holes                                | 4-40 Clinch Nuts | Mounting Holes                          | 4-40 Clinch Nuts |
| 9         | DEA-9P-FO                                     | DEAE-9P-FO       | DEA-9PTI-FO                             | DEAE-9PTI-FO     |
| 15        | DAA-15P-FO                                    | DAAE-15P-FO      | DAA-15PTI-FO                            | DAAE-15PTI-FO    |
| 25        | DBA-25P-FO                                    | DBAE-25P-FO      | DBA-25PTI-FO                            | DBAE-25PTI-FO    |
| 37        | DCA-37P-FO                                    | DCAE-37P-FO      | DCA-37PTI-FO                            | DCAE-37PTI-FO    |
| 50        | DDA-50P-FO                                    | DDAE-50P-FO      | DDA-50PTI-FO                            | DDAE-50PTI-FO    |

### D\*A Series Crimp and Poke Connectors - Sockets

| Positions | Zinc-plated shell with yellow chromate finish |                  | Tin-plated shell |                  |
|-----------|---|------------------|------------------|------------------|
|           | Mounting Holes                                | 4-40 Clinch Nuts | Mounting Holes   | 4-40 Clinch Nuts |
| 9         | DEA-9S-FO                                     | DEAE-9S-FO       | DEA-9ST-FO       | DEAE-9ST-FO      |
| 15        | DAA-15S-FO                                    | DAAE-15S-FO      | DAA-15ST-FO      | DAAE-15ST-FO     |
| 25        | DBA-25S-FO                                    | DBAE-25S-FO      | DBA-25ST-FO      | DBAE-25ST-FO     |
| 37        | DCA-37S-FO                                    | DCAE-37S-FO      | DCA-37ST-FO      | DCAE-37ST-FO     |
| 50        | DDA-50S-FO                                    | DDAE-50S-FO      | DDA-50ST-FO      | DDAE-50ST-FO     |

# D-subminiature Metal Shell Crimp and Poke Insulation Grip Contacts D\*A Series



## Contacts



## Ordering Information

### D\*A Series Crimp and Poke Contacts on Reels

| Contacts per Reel | 15,000     |             | 15,000     |             | 300        |             | 300        |             |
|-------------------|------------|-------------|------------|-------------|------------|-------------|------------|-------------|
| Wire Gauge        | 20-24 AWG  |             | 26-30 AWG  |             | 20-24 AWG  |             | 26-30 AWG  |             |
| Plating           | Gold Flash | 30µin. Gold | Gold Flash | 30µin. Gold | Gold Flash | 30µin. Gold | Gold Flash | 30µin. Gold |
| <b>Pin</b>        | DGP-15-1   | DGP-15-2    | DGP-15-3   | DGP-15-4    | DGP-3-1    | DGP-3-2     | DGP-3-3    | DGP-3-4     |
| <b>Socket</b>     | DGS-15-1   | DGS-15-2    | DGS-15-3   | DGS-15-4    | DGS-3-1    | DGS-3-2     | DGS-3-3    | DGS-3-4     |

### D\*A Series Crimp and Poke Loose-Piece Contacts

| Contacts per Bag | 100        |             | 100        |             | 1000        |             | 1000        |             |
|------------------|------------|-------------|------------|-------------|-------------|-------------|-------------|-------------|
| Wire Gauge       | 20-24 AWG  |             | 26-30 AWG  |             | 20-24 AWG   |             | 26-30 AWG   |             |
| Plating          | Gold Flash | 30µin. Gold | Gold Flash | 30µin. Gold | Gold Flash  | 30µin. Gold | Gold Flash  | 30µin. Gold |
| <b>Pin</b>       | DGP-100L-1 | DGP-100L-2  | DGP-100L-3 | DGP-100L-4  | DGP-1000L-1 | DGP-1000L-2 | DGP-1000L-3 | DGP-1000L-4 |
| <b>Socket</b>    | DGS-100L-1 | DGS-100L-2  | DGS-100L-3 | DGS-100L-4  | DGS-1000L-1 | DGS-1000L-2 | DGS-1000L-3 | DGS-1000L-4 |

# D-subminiature Metal Shell Overmold Kits D\*A and HTD Series



FEATURES

- Cinch overmold kits enable you to overmold the connector of the cable assembly for less material and process cost (versus a metal backshell), improved appearance, and improved shielding of the connector to help meet RFI/EMI requirements.
- An Overmold Kit catalog number consists of:
  - D\*A or HTD Crimp and Poke connector.
  - Inside shielding cover.
  - Outside shielding cover.
- You will also need to order the following:
  - Crimp and Poke stamped contacts must be ordered separately on page 4-22 for D\*A and page 4-18 for HTD connectors.
  - Ferrules are required, but must be ordered separately according to the size necessary to accommodate the wire. See page 4-25.
  - Termination tooling is required to crimp the wires on the connector.
  - A hand tool and appropriate crimping die are required for crimping the ferrule.
- All specifications on the connector portion of the overmold kit can be found on pages 4-16 thru 4-17 for HPD 1.5 density and pages 4-20 thru 4-21 for D\*A series.

MATERIALS

Shield Covers: Steel (stamped) with tin/lead finish  
Ferrule: Brass



## Dimensions

### Overmold Shielding Kits

| Positions | C     |      | D     |       | E     |       | F     |       | G    | H     |       |
|-----------|-------|------|-------|-------|-------|-------|-------|-------|------|-------|-------|
|           | in    | mm   | in    | mm    | in    | mm    | in    | mm    | Deg. | in    | mm    |
| 9 Plug    | 0.270 | 6.86 | 0.705 | 17.91 | 1.320 | 33.53 | 0.520 | 13.21 | 75°  | 0.440 | 11.18 |
| 9 Socket  | 0.285 | 7.24 | 0.705 | 17.91 | 1.320 | 33.53 | 0.520 | 13.21 | 75°  | 0.440 | 11.18 |
| 15 Plug   | 0.270 | 6.86 | 1.050 | 26.67 | 1.320 | 33.53 | 0.520 | 13.21 | 58°  | 0.440 | 11.18 |
| 15 Socket | 0.285 | 7.24 | 1.050 | 26.67 | 1.320 | 33.53 | 0.520 | 13.21 | 58°  | 0.440 | 11.18 |
| 25 Plug   | 0.275 | 6.99 | 1.590 | 40.39 | 1.320 | 33.53 | 0.520 | 13.21 | 40°  | 0.440 | 11.18 |
| 25 Socket | 0.285 | 7.24 | 1.590 | 40.39 | 1.320 | 33.53 | 0.520 | 13.21 | 40°  | 0.440 | 11.18 |
| 37 Plug   | 0.275 | 6.99 | 2.240 | 56.90 | 1.620 | 41.15 | 0.750 | 19.05 | 32°  | 0.520 | 13.21 |
| 37 Socket | 0.285 | 7.24 | 2.240 | 56.90 | 1.620 | 41.15 | 0.750 | 19.05 | 32°  | 0.520 | 13.21 |

# D-subminiature Metal Shell Overmold Kits and Ferrules D\*A and HTD Series

## Overmold Kits (Cont'd)

### Ordering Information

#### D\*A Series Crimp and Poke Overmold Kits

| Positions | Tin-plated shell |               |
|-----------|------------------|---------------|
|           | Plugs            | Sockets       |
| 9         | DEAO-9PTI-FO1    | DEAO-9ST-FO1  |
| 15        | DAAO-15PTI-FO1   | DAAO-15ST-FO1 |
| 25        | DBAO-25PTI-FO1   | DBAO-25ST-FO1 |
| 37        | DCAO-37PTI-FO1   | DCAO-37ST-FO1 |

#### HTD Series 1.5 Density Plugs Overmold Kits

| Size | Shell Size | Catalog Number  |
|------|------------|-----------------|
| 15   | E          | HTDEO-15PTI-FO1 |
| 26   | A          | HTDAO-26PTI-FO1 |
| 44   | B          | HTDBO-44PTI-FO1 |

### Crimp Ferrule



### Ordering Information

| Catalog Number | Type | J    |       | K    |       | L    |       | Crimp Die Catalog No. |
|----------------|------|------|-------|------|-------|------|-------|-----------------------|
|                |      | in   | mm    | in   | mm    | in   | mm    |                       |
| CF-51          | 1    | .437 | 11.10 | .200 | 5.08  | .450 | 11.43 | CD-07                 |
| CF-42          | 1    | .437 | 11.10 | .235 | 5.97  | .450 | 11.43 | CD-00                 |
| CF-43          | 1    | .437 | 11.10 | .250 | 6.35  | .450 | 11.43 | CD-01                 |
| CF-44          | 1    | .437 | 11.10 | .325 | 8.26  | .450 | 11.43 | CD-02                 |
| CF-45          | 1    | .437 | 11.10 | .350 | 8.89  | .450 | 11.43 | CD-03                 |
| CF-46          | 1    | .437 | 11.10 | .375 | 9.53  | .450 | 11.43 | CD-04                 |
| CF-47          | 2    | .437 | 11.10 | .437 | 11.10 | .450 | 11.43 | CD-05                 |
| CF-50          | 2    | .460 | 11.68 | .460 | 11.68 | .450 | 11.43 | CD-06                 |

- Pneumatic Bench Top Press for Crimping Ferrules #FCT-551. See page 4-103.
- Hand Tool for Crimping Ferrules #FCT-552. See page 4-103.



# D-subminiature Metal Shell Crimp and Poke, Right-Angle and Vertical PCB D\*U Series



## FEATURES

- Offered in 9, 15, 25, 37, and 50 position plugs and sockets (except right-angle PCB connectors- 9, 15, and 25 positions).
- Available with gold flash or 30µin. gold plating.
- Offered with .120 mounting holes, optional 4-40 clinch nuts, or dual float bushings (except right-angle PCB connectors-mounting holes only).
- Approvals:
  - UL Recognized - Files E170218 (UL1977) and E130965 (UL1863).
  - CSA Approved - File LR31996.
- See pages 4-5 thru 4-10 for standard dimensions, contact arrangements, and panel mounting specifications.

## MATERIALS

**Insulator Material:** Glass-filled nylon (black), UL 94 V-O rated  
**Connector Shell:** Steel with zinc plating and yellow chromate finish or tin plating (grounding indents on plug)  
**4-40 Clinch Nut:** Steel with cadmium plating and yellow chromate finish  
**Dual Float Bushing:** Stainless steel, passivated

## ENVIRONMENTAL

**Operating Temperature:** -65°C to + 125°C  
**Shock:** 50G peak per MIL-STD-202, Method 213, Condition G  
**Vibration:** 12 cycles in three perpendicular directions @ 10-2000Hz, per MIL-STD-202, Method 204, Condition D  
**Moisture Resistance:** 90-95% relative humidity @ 40°C for 96 hours per MIL-STD-202, Method 103

## ELECTRICAL

**Withstanding Voltage:** Minimum 1000V RMS @ sea level  
**Current Rating:** 5 Amps  
**Contact Resistance:** 2.7 milliohms maximum  
**Insulation Resistance:** 5000 megohms maximum (initial); 1000 megohms (minimum) after environmental testing

## MECHANICAL

**Individual Contact Insertion and Separation Force (minimum/maximum):** 0.7 oz./12 oz.  
**Durability:** 500 mating cycles



# D-subminiature Metal Shell Crimp and Poke D\*U Series



- Machined contacts supplied loose with connector or can be ordered separately. Use with 20-24 AWG wire.
- Stamped Contacts (order separately) for use when ordering connector with contacts not included (-FO option). Use with 20-28 AWG wire.
  - Available in 10K reel.
  - Order reels of stamped contacts separately.

## Materials

- Contact Material: Plug - Brass (stamped) or copper alloy (machined). Socket - Phosphor bronze (stamped) or copper alloy (machined).
- Contact Plating:
  - Stamped Plugs and Sockets: Gold flash or 30µin. gold and gold flash on the remainder. All over nickel.
  - Machined Plugs and Sockets: Gold flash or 30µin. gold. All over nickel.

## Termination Tooling

- Semi-Automatic Stripper Crimper for Stamped Contacts on 10K PC reels: #ESC-20-3. See page 4-102.
- Contact Insertion/Extraction: #CIET-20-HDB. See page 4-101.
- Loose Contact Crimp Tool:

Machined Contact - #M22520/2-01. See page 4-103.  
For Positioner as required see page 4-103.

Stamped Contacts #BT-20-HC see page 4-101.  
No positioner required.

**D-subminiature Metal Shell  
Crimp and Poke  
D\*U Series**



**Ordering Information**

**D\*U Crimp and Poke Plugs**

**Zinc-Plated Shell with Yellow Chromate Finish**

| Position | Mounting Holes    |                  | 4-40 Clinch Nuts  |                  | Dual Float Bushings |                  |
|----------|-------------------|------------------|-------------------|------------------|---------------------|------------------|
|          | Contacts Included | Without Contacts | Contacts Included | Without Contacts | Contacts Included   | Without Contacts |
| 9        | DEU-9P            | DEU-9P-FO        | DEUE-9-P          | DEUE-9P-FO       | DEUY-9P             | DEUY-9P-FO       |
| 15       | DAU-15P           | DAU-15P-FO       | DAUE-15-P         | DAUE-15-P-FO     | DAUY-15P            | DAUY-15P-FO      |
| 25       | DBU-25P           | DBU-25P-FO       | DBUE-25-P         | DBUE-25P-FO      | DBUY-25P            | DBUY-25P-FO      |
| 37       | DCU-37P           | DCU-37P-FO       | DCUE-37-P         | DCUE-37P-FO      | DCUY-37P            | DCUY-37P-FO      |
| 50       | DDU-50P           | DDU-50P-FO       | DDUE-50-P         | DDUE-50P-FO      | DDUY-50P            | DDUY-50P-FO      |

**Tin-Plated Shell with Grounding Indents**

| Position | Mounting Holes    |                  | 4-40 Clinch Nuts  |                  | Dual Float Bushings |                  |
|----------|-------------------|------------------|-------------------|------------------|---------------------|------------------|
|          | Contacts Included | Without Contacts | Contacts Included | Without Contacts | Contacts Included   | Without Contacts |
| 9        | DEU-9PTI          | DEU-9PTI-FO      | DEUE-9PTI         | DEUE-9PTI-FO     | DEUY-9PTI           | DEUY-9PTI-FO     |
| 15       | DAU-15PTI         | DAU-15PTI-FO     | DAUE-15PTI        | DAUE-15PTI-FO    | DAUY-15PTI          | DAUY-15PTI-FO    |
| 25       | DBU-25PTI         | DBU-25PTI-FO     | DBUE-25PTI        | DBUE-25PTI-FO    | DBUY-25PTI          | DBUY-25PTI-FO    |
| 37       | DCU-37PTI         | DCU-37PTI-FO     | DCUE-37PTI        | DCUE-37PTI-FO    | DCUY-37PTI          | DCUY-37PTI-FO    |
| 50       | DDU-50PTI         | DDU-50PTI-FO     | DDUE-50PTI        | DDUE-50PTI-FO    | DDUY-50PTI          | DDUY-50PTI-FO    |

**D\*U Crimp and Poke Sockets**

**Zinc-Plated Shell with Yellow Chromate Finish**

| Position | Mounting Holes    |                  | 4-40 Clinch Nuts  |                  | Dual Float Bushings |                  |
|----------|-------------------|------------------|-------------------|------------------|---------------------|------------------|
|          | Contacts Included | Without Contacts | Contacts Included | Without Contacts | Contacts Included   | Without Contacts |
| 9        | DEU-9S            | DEU-9S-FO        | DEUE-9S           | DEUE-9S-FO       | DEUY-9S             | DEUY-9S-FO       |
| 15       | DAU-15S           | DAU-15S-FO       | DAUE-15S          | DAUE-15S-FO      | DAUY-15S            | DAUY-15S-FO      |
| 25       | DBU-25S           | DBU-25S-FO       | DBUE-25S          | DBUE-25S-FO      | DBUY-25S            | DBUY-25S-FO      |
| 37       | DCU-37S           | DCU-37S-FO       | DCUE-37S          | DCUE-37S-FO      | DCUY-37S            | DCUY-37S-FO      |
| 50       | DDU-50S           | DDU-50S-FO       | DDUE-50S          | DDUE-50S-FO      | DDUY-50S            | DDUY-50S-FO      |

**Tin-Plated Shell**

| Position | Mounting Holes    |                  | 4-40 Clinch Nuts  |                  | Dual Float Bushings |                  |
|----------|-------------------|------------------|-------------------|------------------|---------------------|------------------|
|          | Contacts Included | Without Contacts | Contacts Included | Without Contacts | Contacts Included   | Without Contacts |
| 9        | DEU-9ST           | DEU-9ST-FO       | DEUE-9ST          | DEUE-9ST-FO      | DEUY-9ST            | DEUY-9ST-FO      |
| 15       | DAU-15ST          | DAU-15ST-FO      | DAUE-15ST         | DAUE-15ST-FO     | DAUY-15ST           | DAUY-15ST-FO     |
| 25       | DBU-25ST          | DBU-25ST-FO      | DBUE-25ST         | DBUE-25ST-FO     | DBUY-25ST           | DBUY-25ST-FO     |
| 37       | DCU-37ST          | DCU-37ST-FO      | DCUE-37ST         | DCUE-37ST-FO     | DCUY-37ST           | DCUY-37ST-FO     |
| 50       | DDU-50ST          | DDU-50ST-FO      | DDUE-50ST         | DDUE-50ST-FO     | DDUY-50ST           | DDUY-50ST-FO     |

# D-subminiature Metal Shell Crimp and Poke Contacts D\*U Series



## Machined Contacts • 20-24 AWG Wire



### Dimensions

| Description | Wire<br>AWG | A    |      | B    |      | C Max. |       |
|-------------|-------------|------|------|------|------|--------|-------|
|             |             | in   | mm   | in   | mm   | in     | mm    |
| Pin         | #20, 22, 24 | .066 | 1.67 | .045 | 1.14 | .537   | 13.64 |
| Socket      | #20, 22, 24 | .066 | 1.67 | .045 | 1.14 | .523   | 13.28 |

### Ordering Information

#### D\*U Series Loose-Piece Machined Contacts

|        | Gold Flash   | 30µin. Gold  |
|--------|--------------|--------------|
| Pin    | 030-1952-000 | 030-1952-030 |
| Socket | 030-1953-000 | 030-1953-030 |

## Stamped Contacts • 20-28 AWG Wire



### Ordering Information

#### D\*U Series Stamped Contacts on 10K Reels

|        | Gold Flash   | 30µin. Gold |
|--------|--------------|-------------|
| Pin    | BCL-1964-20P | D110238-034 |
| Socket | BCL-1963-20S | D110238-035 |



# D-subminiature Metal Shell Right-Angle Dip Solder PCB D\*U Series



- .445" footprint.
- .024" contact diameter.

## Materials

- Contact Material: Socket - Copper alloy (machined), Plug - Brass (machined).
- Contact Plating: Gold flash or 30µin. gold. All over nickel.
- Mounting bracket: Black nylon. Can be removed if necessary.



4

## Ordering Information

### D\*U Right-Angle Plugs

| Positions | Zinc-Plated Shell with Yellow Chromate Finish |              | Tin-Plated Shell with Grounding Indents |                |
|-----------|---|--------------|---|----------------|
|           | Gold Flash                                    | 30µin. Gold  | Gold Flash                              | 30µin. Gold    |
| 9         | DEU-9PAD                                      | DEU-9PAD-30  | DEU-9PADTI                              | DEU-9PADTI-30  |
| 15        | DAU-15PAD                                     | DAU-15PAD-30 | DAU-15PADTI                             | DAU-15PADTI-30 |
| 25        | DBU-25PAD                                     | DBU-25PAD-30 | DBU-25PADTI                             | DBU-25PADTI-30 |

### D\*U Right-Angle Sockets

| Positions | Zinc-Plated Shell with Yellow Chromate Finish |              | Tin-Plated Shell |               |
|-----------|---|--------------|------------------|---------------|
|           | Gold Flash                                    | 30µin. Gold  | Gold Flash       | 30µin. Gold   |
| 9         | DEU-9SAD                                      | DEU-9SAD-30  | DEU-9SADT        | DEU-9SADT-30  |
| 15        | DAU-15SAD                                     | DAU-15SAD-30 | DAU-15SADT       | DAU-15SADT-30 |
| 25        | DBU-25SAD                                     | DBU-25SAD-30 | DBU-25SADT       | DBU-25SADT-30 |

# D-subminiature Metal Shell Vertical Dip Solder PCB D\*U Series



- .024" contact diameter.
- Longer rear insulator provides integral standoff from PCB.

## Materials

- Contact Material: Plug - Brass (machined), Socket - Copper alloy (machined).
- Contact Plating: Gold flash or 30µin. gold. All over nickel.



## Ordering Information

### Vertical Plugs

#### Zinc-Plated Shell with Yellow Chromate Finish

| Positions | Mounting Holes |              | 4-40 Clinch Nuts |               | Dual Float Bushings |               |
|-----------|----------------|--------------|------------------|---------------|---------------------|---------------|
|           | Gold Flash     | 30µin. Gold  | Gold Flash       | 30µin. Gold   | Gold Flash          | 30µin. Gold   |
| 9         | DEU-9PBF       | DEU-9PBF-30  | DEUE-9PBF        | DEUE-9PBF-30  | DEUY-9PBF           | DEUY-9PBF-30  |
| 15        | DAU-15PBF      | DAU-15PBF-30 | DAUE-15PBF       | DAUE-15PBF-30 | DAUY-15PBF          | DAUY-15PBF-30 |
| 25        | DBU-25PBF      | DBU-25PBF-30 | DBUE-25PBF       | DBUE-25PBF-30 | DBUY-25PBF          | DBUY-25PBF-30 |
| 37        | DCU-37PBF      | DCU-37PBF-30 | DCUE-37PBF       | DCUE-37PBF-30 | DCUY-37PBF          | DCUY-37PBF-30 |
| 50        | DDU-50PBF      | DDU-50PBF-30 | DDUE-50PBF       | DDUE-50PBF-30 | DDUY-50PBF          | DDUY-50PBF-30 |

#### Tin-Plated Shell with Grounding Indents

| Positions | Mounting Holes |                | 4-40 Clinch Nuts |                 | Dual Float Bushings |                 |
|-----------|----------------|----------------|------------------|-----------------|---------------------|-----------------|
|           | Gold Flash     | 30µin. Gold    | Gold Flash       | 30µin. Gold     | Gold Flash          | 30µin. Gold     |
| 9         | DEU-9PBFTI     | DEU-9PBFTI-30  | DEUE-9PBFTI      | DEUE-9PBFTI-30  | DEUY-9PBFTI         | DEUY-9PBFTI-30  |
| 15        | DAU-15PBFTI    | DAU-15PBFTI-30 | DAUE-15PBFTI     | DAUE-15PBFTI-30 | DAUY-15PBFTI        | DAUY-15PBFTI-30 |
| 25        | DBU-25PBFTI    | DBU-25PBFTI-30 | DBUE-25PBFTI     | DBUE-25PBFTI-30 | DBUY-25PBFTI        | DBUY-25PBFTI-30 |
| 37        | DCU-37PBFTI    | DCU-37PBFTI-30 | DCUE-37PBFTI     | DCUE-37PBFTI-30 | DCUY-37PBFTI        | DCUY-37PBFTI-30 |
| 50        | DDU-50PBFTI    | DDU-50PBFTI-30 | DDUE-50PBFTI     | DDUE-50PBFTI-30 | DDUY-50PBFTI        | DDUY-50PBFTI-30 |



**D-subminiature Metal Shell  
Vertical Dip Solder PCB  
D\*U Series**



Ordering Information (Cont'd)

Vertical Sockets

Zinc-Plated Shell with Yellow Chromate Finish

| Positions | Mounting Holes |              | 4-40 Clinch Nuts |               | Dual Float Bushings |               |
|-----------|----------------|--------------|------------------|---------------|---------------------|---------------|
|           | Gold Flash     | 30µin. Gold  | Gold Flash       | 30µin. Gold   | Gold Flash          | 30µin. Gold   |
| 9         | DEU-9SBF       | DEU-9SBF-30  | DEUE-9SBF        | DEUE-9SBF-30  | DEUY-9SBF           | DEUY-9SBF-30  |
| 15        | DAU-15SBF      | DAU-15SBF-30 | DAUE-15SBF       | DAUE-15SBF-30 | DAUY-15SBF          | DAUY-15SBF-30 |
| 25        | DBU-25SBF      | DBU-25SBF-30 | DBUE-25SBF       | DBUE-25SBF-30 | DBUY-25SBF          | DBUY-25SBF-30 |
| 37        | DCU-37SBF      | DCU-37SBF-30 | DCUE-37SBF       | DCUE-37SBF-30 | DCUY-37SBF          | DCUY-37SBF-30 |
| 50        | DDU-50SBF      | DDU-50SBF-30 | DDUE-50SBF       | DDUE-50SBF-30 | DDUY-50SBF          | DDUY-50SBF-30 |

Tin-Plated Shell

| Positions | Mounting Holes |               | 4-40 Clinch Nuts |                | Dual Float Bushings |                |
|-----------|----------------|---------------|------------------|----------------|---------------------|----------------|
|           | Gold Flash     | 30µin. Gold   | Gold Flash       | 30µin. Gold    | Gold Flash          | 30µin. Gold    |
| 9         | DEU-9SBFT      | DEU-9SBFT-30  | DEUE-9SBFT       | DEUE-9SBFT-30  | DEUY-9SBFT          | DEUY-9SBFT-30  |
| 15        | DAU-15SBFT     | DAU-15SBFT-30 | DAUE-15SBFT      | DAUE-15SBFT-30 | DAUY-15SBFT         | DAUY-15SBFT-30 |
| 25        | DBU-25SBFT     | DBU-25SBFT-30 | DBUE-25SBFT      | DBUE-25SBFT-30 | DBUY-25SBFT         | DBUY-25SBFT-30 |
| 37        | DCU-37SBFT     | DCU-37SBFT-30 | DCUE-37SBFT      | DCUE-37SBFT-30 | DCUY-37SBFT         | DCUY-37SBFT-30 |
| 50        | DDU-50SBFT     | DDU-50SBFT-30 | DDUE-50SBFT      | DDUE-50SBFT-30 | DDUY-50SBFT         | DDUY-50SBFT-30 |

4

# D-subminiature Metal Shell and All Plastic Solder Cup and IDC T\* Series



## FEATURES

- Offered in 9, 15, 25, and 37 position plugs and sockets.
- Available in Solder Cup and IDC (insulation displacement) terminations for discrete wire.
- Offered with .120 mounting holes.
- Approvals:
  - UL Recognized - Files E170218 (UL1977) and E130965 (UL1863).
  - CSA Approved - File LR31996.
- See pages 4-5 thru 4-10 for standard dimensions, contact arrangements, and panel mounting specifications.

## MATERIALS

**Insulator Material:** Glass-filled polyester (black), UL 94 V-O rated  
**Connector Shell:** Steel with zinc plating and yellow chromate finish or tin plating (grounding indents on plug)  
**Contact Material:** Phosphor bronze (stamped)  
**Contact Plating:** Gold flash or 30µin. gold in mating area and gold flash on the remainder. All over nickel.

## ENVIRONMENTAL

**Operating Temperature:** -65°C to + 125°C  
**Shock:** 50G peak per MIL-STD-202, Method 213, Condition G  
**Vibration:** 12 cycles in three perpendicular directions @ 10-2000Hz, per MIL-STD-202, Method 204, Condition D  
**Moisture Resistance:** 90-95% relative humidity @ 40°C for 96 hours per MIL-STD-202, Method 103

## ELECTRICAL

**Withstanding Voltage:** Minimum 1000V RMS @ sea level  
**Current Rating:** 3 Amps  
**Contact Resistance:** 2.7 milliohms maximum  
**Insulation Resistance:** 5000 megohms maximum (initial); 1000 megohms (minimum) after environmental testing

## MECHANICAL

**Individual Contact Insertion and Separation Force (minimum/maximum):** 0.7 oz./12 oz.  
**Durability:** 500 mating cycles





# D-subminiature Metal Shell Solder Cup for Discrete Cable Wire T\* Series



- Solder channels between barriers permit single-pass soldering of each row without solder bridging.
- Will accommodate up to 22 AWG wire.



## Ordering Information

### Solder Cup Plugs

| Positions | Zinc-Plated Shell<br>with Yellow Chromate Finish |             | Tin-Plated Shell<br>with Grounding Indents |              |
|-----------|--|-------------|--|--------------|
|           | Gold Flash                                       | 30µin. Gold | Gold Flash                                 | 30µin. Gold  |
| 9         | TE-9PS   | TE-9PS-30   | TE-9PTIS                                   | TE-9PTIS-30  |
| 15        | TA-15PS  | TA-15PS-30  | TA-15PTIS                                  | TA-15PTIS-30 |
| 25        | TB-25PS  | TB-25PS-30  | TB-25PTIS                                  | TB-25PTIS-30 |
| 37        | TC-37PS  | TC-37PS-30  | TC-37PTIS                                  | TC-37PTIS-30 |

### Solder Cup Sockets

| Positions | Zinc-Plated Shell<br>with Yellow Chromate Finish |             | Tin-Plated Shell |             |
|-----------|--|-------------|------------------|-------------|
|           | Gold Flash                                       | 30µin. Gold | Gold Flash       | 30µin. Gold |
| 9         | TE-9SS   | TE-9SS-30   | TE-9STS          | TE-9STS-30  |
| 15        | TA-15SS  | TA-15SS-30  | TA-15STS         | TA-15STS-30 |
| 25        | TB-25SS  | TB-25SS-30  | TB-25STS         | TB-25STS-30 |
| 37        | TC-37SS  | TC-37SS-30  | TC-37STS         | TC-37STS-30 |

# D-subminiature Metal Shell IDC for Discrete Cable Wire T\* Series



- Will accommodate 24-26 AWG solid or stranded PVC wire.



## Ordering Information

### IDC Plugs

| Positions | Zinc-Plated Shell<br>with Yellow Chromate Finish |             | Tin-Plated Shell<br>with Grounding Indents |              |
|-----------|--|-------------|--|--------------|
|           | Gold Flash                                       | 30µin. Gold | Gold Flash                                 | 30µin. Gold  |
| 9         | TE-9PSH  | TE-9PSH-30  | TES-9PTI                                   | TES-9PTI-30  |
| 15        | TA-15PSH   | TA-15PSH-30 | TAS-15PTI                                  | TAS-15PTI-30 |
| 25        | TB-25PSH   | TB-25PSH-30 | TBS-25PTI                                  | TBS-25PTI-30 |
| 37        | TC-37PSH   | TC-37PSH-30 | TCS-37PTI                                  | TCS-37PTI-30 |

### IDC Sockets

| Positions | Zinc-Plated Shell<br>with Yellow Chromate Finish |             | Tin-Plated Shell |             |
|-----------|--|-------------|------------------|-------------|
|           | Gold Flash                                       | 30µin. Gold | Gold Flash       | 30µin. Gold |
| 9         | TE-9SSH  | TE-9SSH-30  | TES-9ST          | TES-9ST-30  |
| 15        | TA-15SSH   | TA-15SSH-30 | TAS-15ST         | TAS-15ST-30 |
| 25        | TB-25SSH   | TB-25SSH-30 | TBS-25ST         | TBS-25ST-30 |
| 37        | TC-37SSH   | TC-37SSH-30 | TCS-37ST         | TCS-37ST-30 |

# D-subminiature Metal Shell IDC for Discrete Cable Wire T\* Series



- Auto-Clinch D Semi-Automatic Termination Tool #ACD-432: See page 4-100.
  - Certi-Clinch D Manual Termination Tool #SD-CCWN: For 24-26 AWG wire: See page 4-100.
  - Uni-Clinch D Single-Wire Hand Insertion Tool #SD-UC: See page 4-100.
  - Super D Manual Stay Band Tool #SD-MSBT: See page 4-100.
- 
- Optional strain relief covers for connectors when backshell is not required.

## Ordering Information

| Positions | Catalog No. |
|-----------|-------------|
| 9         | SSD-WC9     |
| 15        | SSD-WC15    |
| 25        | SSD-WC25    |
| 37        | SSD-WC37    |

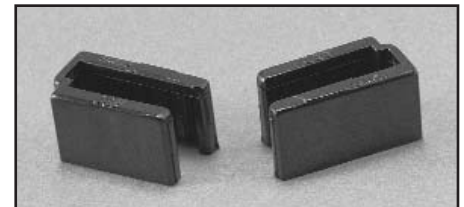
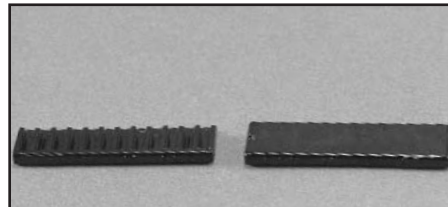

- One-piece cover for 9 contact size. Order one per connector. Two-piece cover for other sizes. Order two per connector.
- Cover fits both plug and socket.

# D-subminiature All-Plastic IDC for Discrete Cable Wire T\* Series



- For use only with SDH Series Gray Backshell on pages 4-89 thru 4-90.
- Offered in 9, 15, 25, and 37 position plugs and sockets.
- Connector will accommodate 24-28 AWG wire.
- Offered with plain flanges and .120 mounting holes, threaded bushings, latch blocks, or latch blocks and threaded bushings.

- Auto-Clinch D Semi-Automatic Termination Tool #ACD-432: See page 4-100.
- Certi-Clinch D Manual Termination Tool #SD-CC for 24-28 AWG wire: See page 4-100.
- Uni-Clinch D Single-Wire Hand Insertion Tool #SD-UC: See page 4-100.
- Super D Manual Stay Band Tool #SD-MSBT: See page 4-100.



Plug with Latching Blocks



Socket with Latching Blocks



## Dimensions

| Positions | A     |       | A     |       | B     |       | CP    |       | CS    |       | D     |       |
|-----------|-------|-------|-------|-------|-------|-------|-------|-------|-------|-------|-------|-------|
|           | in    | mm    | in    | mm    | in    | mm    | in    | mm    | in    | mm    | in    | mm    |
| 9         | 1.209 | 30.71 | 1.309 | 33.25 | .984  | 24.99 | .668  | 16.96 | .642  | 16.31 | .592  | 15.04 |
| 15        | 1.536 | 39.01 | 1.636 | 41.55 | 1.312 | 33.32 | .995  | 25.28 | .970  | 24.64 | .918  | 23.31 |
| 25        | 2.079 | 52.81 | 2.179 | 55.35 | 1.852 | 47.04 | 1.535 | 38.99 | 1.512 | 38.40 | 1.462 | 37.13 |
| 37        | 2.724 | 69.19 | 2.824 | 71.73 | 2.500 | 63.50 | 2.183 | 55.45 | 2.158 | 54.81 | 2.114 | 53.70 |



# D-subminiature All-Plastic IDC for Discrete Wire T\* Series



## Ordering Information

### IDC All-Plastic Plugs

#### Plain Flange

| Positions | Mounting Holes |             | 4-40 Threaded Bushings |             |
|-----------|----------------|-------------|------------------------|-------------|
|           | Gold Flash     | 30µin. Gold | Gold Flash             | 30µin. Gold |
| 9         | TE-9P          | TE-9P-30    | TE-9PTB                | TE-9PTB-30  |
| 15        | TA-15P         | TA-15P-30   | TA-15PTB               | TA-15PTB-30 |
| 25        | TB-25P         | TB-25P-30   | TB-25PTB               | TB-25PTB-30 |
| 37        | TC-37P         | TC-37P-30   | TC-37PTB               | TC-37PTB-30 |

#### Flange with Latch Block

| Positions | Mounting Holes |             | 4-40 Threaded Bushings |               |
|-----------|----------------|-------------|------------------------|---------------|
|           | Gold Flash     | 30µin. Gold | Gold Flash             | 30µin. Gold   |
| 9         | TE-9PLB        | TE-9PLB-30  | TE-9PLB-1              | TE-9PLB-1-30  |
| 15        | TA-15PLB       | TA-15PLB-30 | TA-15PLB-1             | TA-15PLB-1-30 |
| 25        | TB-25PLB       | TB-25PLB-30 | TB-25PLB-1             | TB-25PLB-1-30 |
| 37        | TC-37PLB       | TC-37PLB-30 | TC-37PLB-1             | TC-37PLB-1-30 |

### IDC All-Plastic Sockets

#### Plain Flange

| Positions | Mounting Holes |             | 4-40 Threaded Bushings |             |
|-----------|----------------|-------------|------------------------|-------------|
|           | Gold Flash     | 30µin. Gold | Gold Flash             | 30µin. Gold |
| 9         | TE-9S          | TE-9S-30    | TE-9STB                | TE-9STB-30  |
| 15        | TA-15S         | TA-15S-30   | TA-15STB               | TA-15STB-30 |
| 25        | TB-25S         | TB-25S-30   | TB-25STB               | TB-25STB-30 |
| 37        | TC-37S         | TC-37S-30   | TC-37STB               | TC-37STB-30 |

#### Flange with Latch Block

| Positions | Mounting Holes |             | 4-40 Threaded Bushings |               |
|-----------|----------------|-------------|------------------------|---------------|
|           | Gold Flash     | 30µin. Gold | Gold Flash             | 30µin. Gold   |
| 9         | TE-9SLB        | TE-9SLB-30  | TE-9SLB-1              | TE-9SLB-1-30  |
| 15        | TA-15SLB       | TA-15SLB-30 | TA-15SLB-1             | TA-15SLB-1-30 |
| 25        | TB-25SLB       | TB-25SLB-30 | TB-25SLB-1             | TB-25SLB-1-30 |
| 37        | TC-37SLB       | TC-37SLB-30 | TC-37SLB-1             | TC-37SLB-1-30 |

# D-subminiature Metal Shell Solder Cup, Vertical PCB Mount, and Wire Wrap Basic D Series



## FEATURES

- Offered in Wire Wrap and Solder Cup styles for wire termination and vertical style for PCB mount.
- Offered with .120 mounting holes, 4-40 clinch nuts, and dual float bushings.
- Offered in 9, 15, 25, 37, and 50 position plugs and sockets.
- Available with gold flash or 30µin. gold plating.
- Approvals:
  - UL Recognized - Files E170218 (UL1977) and E130965 (UL1863).
  - CSA Approved - File LR31996.
- See pages 4-5 thru 4-10 for standard dimensions, contact arrangements, and panel mounting specifications.

## MATERIALS

**Insulator Material:** Glass-filled polyester (white), UL 94V-O rated  
**Connector Shell:** Steel with zinc plating and yellow chromate finish or tin plating (grounding indents on plug)  
**4-40 Clinch Nut:** Steel with cadmium plating and yellow chromate finish  
**Dual Float Bushing:** Stainless steel, passivated

## ENVIRONMENTAL

**Operating Temperature:** -65°C to + 125°C  
**Shock:** 50G peak per MIL-STD-202, Method 213, Condition G  
**Vibration:** 12 cycles in three perpendicular directions @ 10-2000Hz, per MIL-STD-202, Method 204, Condition D  
**Moisture Resistance:** 90-95% relative humidity @ 40°C for 96 hours per MIL-STD-202, Method 103

## ELECTRICAL

**Withstanding Voltage:** Minimum 1250V RMS @ sea level  
**Current Rating:** 5 Amps  
**Contact Resistance:** 2.7 milliohms maximum  
**Insulation Resistance:** 5000 megohms maximum (initial); 1000 megohms (minimum) after environmental testing

## MECHANICAL

**Individual Contact Insertion and Separation Force (minimum/maximum):** 0.7 oz./12 oz.  
**Durability:** 500 mating cycles



# D-subminiature Metal Shell Solder Cup Basic D Series



- Available with stamped or machined contacts.
- Will accommodate up to 20 AWG wire.

## Materials

- Contact Material: Copper Alloy
- Contact Plating:
  - Stamped contacts with gold flash or 30µin. gold in mating area, gold flash or tin/lead on remainder. All over nickel.
  - Screw machine contacts with gold flash or 30µin. gold. All over nickel.



## Ordering Information

### Solder Cup Plugs

#### Zinc-Plated Shell with Yellow Chromate Finish

##### Stamped Contact with Gold Flash in Solder Cup

| Positions | Mounting Holes |             | 4-40 Clinch Nuts |             | Dual Float Bushings |             |
|-----------|----------------|-------------|------------------|-------------|---------------------|-------------|
|           | Gold Flash     | 30µin. Gold | Gold Flash       | 30µin. Gold | Gold Flash          | 30µin. Gold |
| 9         | DE-9P          | DE-9P-30    | DEE-9P           | DEE-9P-30   | DEY-9P              | DEY-9P-30   |
| 15        | DA-15P         | DA-15P-30   | DAE-15P          | DAE-15P-30  | DAY-15P             | DAY-15P-30  |
| 25        | DB-25P         | DB-25P-30   | DBE-25P          | DBE-25P-30  | DBY-25P             | DBY-25P-30  |
| 37        | DC-37P         | DC-37P-30   | DCE-37P          | DCE-37P-30  | DCY-37P             | DCY-37P-30  |
| 50        | DD-50P         | DD-50P-30   | DDE-50P          | DDE-50P-30  | DDY-50P             | DDY-50P-30  |

##### Stamped Contact with Tin/Lead in Solder Cup

| Positions | Mounting Holes |              | 4-40 Clinch Nuts |               | Dual Float Bushings |               |
|-----------|----------------|--------------|------------------|---------------|---------------------|---------------|
|           | Gold Flash     | 30µin. Gold  | Gold Flash       | 30µin. Gold   | Gold Flash          | 30µin. Gold   |
| 9         | DE-9P-II       | DE-9P-II-30  | DEE-9P-II        | DEE-9P-II-30  | DEY-9P-II           | DEY-9P-II-30  |
| 15        | DA-15P-II      | DA-15P-II-30 | DAE-15P-II       | DAE-15P-II-30 | DAY-15P-II          | DAY-15P-II-30 |
| 25        | DB-25P-II      | DB-25P-II-30 | DBE-25P-II       | DBE-25P-II-30 | DBY-25P-II          | DBY-25P-II-30 |
| 37        | DC-37P-II      | DC-37P-II-30 | DCE-37P-II       | DCE-37P-II-30 | DCY-37P-II          | DCY-37P-II-30 |
| 50        | DD-50P-II      | DD-50P-II-30 | DDE-50P-II       | DDE-50P-II-30 | DDY-50P-II          | DDY-50P-II-30 |

##### Screw Machine Contact

| Positions | Mounting Holes |              | 4-40 Clinch Nuts |               | Dual Float Bushings |               |
|-----------|----------------|--------------|------------------|---------------|---------------------|---------------|
|           | Gold Flash     | 30µin. Gold  | Gold Flash       | 30µin. Gold   | Gold Flash          | 30µin. Gold   |
| 9         | DE-9P-SM       | DE-9P-SM-30  | DEE-9P-SM        | DEE-9P-SM-30  | DEY-9P-SM           | DEY-9P-SM-30  |
| 15        | DA-15P-SM      | DA-15P-SM-30 | DAE-15P-SM       | DAE-15P-SM-30 | DAY-15P-SM          | DAY-15P-SM-30 |
| 25        | DB-25P-SM      | DB-25P-SM-30 | DBE-25P-SM       | DBE-25P-SM-30 | DBY-25P-SM          | DBY-25P-SM-30 |
| 37        | DC-37P-SM      | DC-37P-SM-30 | DCE-37P-SM       | DCE-37P-SM-30 | DCY-37P-SM          | DCY-37P-SM-30 |
| 50        | DD-50P-SM      | DD-50P-SM-30 | DDE-50P-SM       | DDE-50P-SM-30 | DDY-50P-SM          | DDY-50P-SM-30 |



# D-subminiature Metal Shell Solder Cup Basic D Series



## Ordering Information

### Solder Cup Plugs (Cont'd)

#### Tin-Plated Shell with Grounding Indents

##### Stamped Contact with Gold Flash in Solder Cup

| Positions | Mounting Holes |             | 4-40 Clinch Nuts |              | Dual Float Bushings |              |
|-----------|----------------|-------------|------------------|--------------|---------------------|--------------|
|           | Gold Flash     | 30µin. Gold | Gold Flash       | 30µin. Gold  | Gold Flash          | 30µin. Gold  |
| 9         | DE-9PTI        | DE-9PTI-30  | DEE-9PTI         | DEE-9PTI-30  | DEY-9PTI            | DEY-9PTI-30  |
| 15        | DA-15PTI       | DA-15PTI-30 | DAE-15PTI        | DAE-15PTI-30 | DAY-15PTI           | DAY-15PTI-30 |
| 25        | DB-25PTI       | DB-25PTI-30 | DBE-25PTI        | DBE-25PTI-30 | DBY-25PTI           | DBY-25PTI-30 |
| 37        | DC-37PTI       | DC-37PTI-30 | DCE-37PTI        | DCE-37PTI-30 | DCY-37PTI           | DCY-37PTI-30 |
| 50        | DD-50PTI       | DD-50PTI-30 | DDE-50PTI        | DDE-50PTI-30 | DDY-50PTI           | DDY-50PTI-30 |

##### Stamped Contact with Tin/Lead in Solder Cup

| Positions | Mounting Holes |                | 4-40 Clinch Nuts |                 | Dual Float Bushings |                 |
|-----------|----------------|----------------|------------------|-----------------|---------------------|-----------------|
|           | Gold Flash     | 30µin. Gold    | Gold Flash       | 30µin. Gold     | Gold Flash          | 30µin. Gold     |
| 9         | DE-9PTI-II     | DE-9PTI-II-30  | DEE-9PTI-II      | DEE-9PTI-II-30  | DEY-9PTI-II         | DEY-9PTI-II-30  |
| 15        | DA-15PTI-II    | DA-15PTI-II-30 | DAE-15PTI-II     | DAE-15PTI-II-30 | DAY-15PTI-II        | DAY-15PTI-II-30 |
| 25        | DB-25PTI-II    | DB-25PTI-II-30 | DBE-25PTI-II     | DBE-25PTI-II-30 | DBY-25PTI-II        | DBY-25PTI-II-30 |
| 37        | DC-37PTI-II    | DC-37PTI-II-30 | DCE-37PTI-II     | DCE-37PTI-II-30 | DCY-37PTI-II        | DCY-37PTI-II-30 |
| 50        | DD-50PTI-II    | DD-50PTI-II-30 | DDE-50PTI-II     | DDE-50PTI-II-30 | DDY-50PTI-II        | DDY-50PTI-II-30 |

##### Screw Machine Contact

| Positions | Mounting Holes |                | 4-40 Clinch Nuts |                 | Dual Float Bushings |                 |
|-----------|----------------|----------------|------------------|-----------------|---------------------|-----------------|
|           | Gold Flash     | 30µin. Gold    | Gold Flash       | 30µin. Gold     | Gold Flash          | 30µin. Gold     |
| 9         | DE-9PTI-SM     | DE-9PTI-SM-30  | DEE-9PTI-SM      | DEE-9PTI-SM-30  | DEY-9PTI-SM         | DEY-9PTI-SM-30  |
| 15        | DA-15PTI-SM    | DA-15PTI-SM-30 | DAE-15PTI-SM     | DAE-15PTI-SM-30 | DAY-15PTI-SM        | DAY-15PTI-SM-30 |
| 25        | DB-25PTI-SM    | DB-25PTI-SM-30 | DBE-25PTI-SM     | DBE-25PTI-SM-30 | DBY-25PTI-SM        | DBY-25PTI-SM-30 |
| 37        | DC-37PTI-SM    | DC-37PTI-SM-30 | DCE-37PTI-SM     | DCE-37PTI-SM-30 | DCY-37PTI-SM        | DCY-37PTI-SM-30 |
| 50        | DD-50PTI-SM    | DD-50PTI-SM-30 | DDE-50PTI-SM     | DDE-50PTI-SM-30 | DDY-50PTI-SM        | DDY-50PTI-SM-30 |



# D-subminiature Metal Shell Solder Cup Basic D Series



## Ordering Information

### Solder Cup Sockets

#### Zinc-Plated Shell with Yellow Chromate Finish

##### Stamped Contact with Gold Flash in Solder Cup

| Positions | Mounting Holes |             | 4-40 Clinch Nuts |             | Dual Float Bushings |             |
|-----------|----------------|-------------|------------------|-------------|---------------------|-------------|
|           | Gold Flash     | 30µin. Gold | Gold Flash       | 30µin. Gold | Gold Flash          | 30µin. Gold |
| 9         | DE-9S          | DE-9S-30    | DEE-9S           | DEE-9S-30   | DEY-9S              | DEY-9S-30   |
| 15        | DA-15S         | DA-15S-30   | DAE-15S          | DAE-15S-30  | DAY-15S             | DAY-15S-30  |
| 25        | DB-25S         | DB-25S-30   | DBE-25S          | DBE-25S-30  | DBY-25S             | DBY-25S-30  |
| 37        | DC-37S         | DC-37S-30   | DCE-37S          | DCE-37S-30  | DCY-37S             | DCY-37S-30  |
| 50        | DD-50S         | DD-50S-30   | DDE-50S          | DDE-50S-30  | DDY-50S             | DDY-50S-30  |

##### Stamped Contact Tin/Lead in Solder Cup

| Positions | Mounting Holes |              | 4-40 Clinch Nuts |               | Dual Float Bushings |               |
|-----------|----------------|--------------|------------------|---------------|---------------------|---------------|
|           | Gold Flash     | 30µin. Gold  | Gold Flash       | 30µin. Gold   | Gold Flash          | 30µin. Gold   |
| 9         | DE-9S-II       | DE-9S-II-30  | DEE-9S-II        | DEE-9S-II-30  | DEY-9S-II           | DEY-9S-II-30  |
| 15        | DA-15S-II      | DA-15S-II-30 | DAE-15S-II       | DAE-15S-II-30 | DAY-15S-II          | DAY-15S-II-30 |
| 25        | DB-25S-II      | DB-25S-II-30 | DBE-25S-II       | DBE-25S-II-30 | DBY-25S-II          | DBY-25S-II-30 |
| 37        | DC-37S-II      | DC-37S-II-30 | DCE-37S-II       | DCE-37S-II-30 | DCY-37S-II          | DCY-37S-II-30 |
| 50        | DD-50S-II      | DD-50S-II-30 | DDE-50S-II       | DDE-50S-II-30 | DDY-50S-II          | DDY-50S-II-30 |

##### Screw Machine Contact

| Positions | Mounting Holes |              | 4-40 Clinch Nuts |               | Dual Float Bushings |               |
|-----------|----------------|--------------|------------------|---------------|---------------------|---------------|
|           | Gold Flash     | 30µin. Gold  | Gold Flash       | 30µin. Gold   | Gold Flash          | 30µin. Gold   |
| 9         | DE-9S-SM       | DE-9S-SM-30  | DEE-9S-SM        | DEE-9S-SM-30  | DEY-9S-SM           | DEY-9S-SM-30  |
| 15        | DA-15S-SM      | DA-15S-SM-30 | DAE-15S-SM       | DAE-15S-SM-30 | DAY-15S-SM          | DAY-15S-SM-30 |
| 25        | DB-25S-SM      | DB-25S-SM-30 | DBE-25S-SM       | DBE-25S-SM-30 | DBY-25S-SM          | DBY-25S-SM-30 |
| 37        | DC-37S-SM      | DC-37S-SM-30 | DCE-37S-SM       | DCE-37S-SM-30 | DCY-37S-SM          | DCY-37S-SM-30 |
| 50        | DD-50S-SM      | DD-50S-SM-30 | DDE-50S-SM       | DDE-50S-SM-30 | DDY-50S-SM          | DDY-50S-SM-30 |

### Tin-Plated Shell

##### Stamped Contact with Gold Flash in Solder Cup

| Positions | Mounting Holes |             | 4-40 Clinch Nuts |             | Dual Float Bushings |             |
|-----------|----------------|-------------|------------------|-------------|---------------------|-------------|
|           | Gold Flash     | 30µin. Gold | Gold Flash       | 30µin. Gold | Gold Flash          | 30µin. Gold |
| 9         | DE-9ST         | DE-9ST-30   | DEE-9ST          | DEE-9ST-30  | DEY-9ST             | DEY-9ST-30  |
| 15        | DA-15ST        | DA-15ST-30  | DAE-15ST         | DAE-15ST-30 | DAY-15ST            | DAY-15ST-30 |
| 25        | DB-25ST        | DB-25ST-30  | DBE-25ST         | DBE-25ST-30 | DBY-25ST            | DBY-25ST-30 |
| 37        | DC-37ST        | DC-37ST-30  | DCE-37ST         | DCE-37ST-30 | DCY-37ST            | DCY-37ST-30 |
| 50        | DD-50ST        | DD-50ST-30  | DDE-50ST         | DDE-50ST-30 | DDY-50ST            | DDY-50ST-30 |

##### Stamped Contact with Tin/Lead in Solder Cup

| Positions | Mounting Holes |               | 4-40 Clinch Nuts |                | Dual Float Bushings |                |
|-----------|----------------|---------------|------------------|----------------|---------------------|----------------|
|           | Gold Flash     | 30µin. Gold   | Gold Flash       | 30µin. Gold    | Gold Flash          | 30µin. Gold    |
| 9         | DE-9ST-II      | DE-9ST-II-30  | DEE-9ST-II       | DEE-9ST-II-30  | DEY-9ST-II          | DEY-9ST-II-30  |
| 15        | DA-15ST-II     | DA-15ST-II-30 | DAE-15ST-II      | DAE-15ST-II-30 | DAY-15ST-II         | DAY-15ST-II-30 |
| 25        | DB-25ST-II     | DB-25ST-II-30 | DBE-25ST-II      | DBE-25ST-II-30 | DBY-25ST-II         | DBY-25ST-II-30 |
| 37        | DC-37ST-II     | DC-37ST-II-30 | DCE-37ST-II      | DCE-37ST-II-30 | DCY-37ST-II         | DCY-37ST-II-30 |
| 50        | DD-50ST-II     | DD-50ST-II-30 | DDE-50ST-II      | DDE-50ST-II-30 | DDY-50ST-II         | DDY-50ST-II-30 |

##### Screw Machine Contact

| Positions | Mounting Holes |               | 4-40 Clinch Nuts |                | Dual Float Bushings |                |
|-----------|----------------|---------------|------------------|----------------|---------------------|----------------|
|           | Gold Flash     | 30µin. Gold   | Gold Flash       | 30µin. Gold    | Gold Flash          | 30µin. Gold    |
| 9         | DE-9ST-SM      | DE-9ST-SM-30  | DEE-9ST-SM       | DEE-9ST-SM-30  | DEY-9ST-SM          | DEY-9ST-SM-30  |
| 15        | DA-15ST-SM     | DA-15ST-SM-30 | DAE-15ST-SM      | DAE-15ST-SM-30 | DAY-15ST-SM         | DAY-15ST-SM-30 |
| 25        | DB-25ST-SM     | DB-25ST-SM-30 | DBE-25ST-SM      | DBE-25ST-SM-30 | DBY-25ST-SM         | DBY-25ST-SM-30 |
| 37        | DC-37ST-SM     | DC-37ST-SM-30 | DCE-37ST-SM      | DCE-37ST-SM-30 | DCY-37ST-SM         | DCY-37ST-SM-30 |
| 50        | DD-50ST-SM     | DD-50ST-SM-30 | DDE-50ST-SM      | DDE-50ST-SM-30 | DDY-50ST-SM         | DDY-50ST-SM-30 |



# D-subminiature Metal Shell Vertical Dip Solder PCB Basic D Series



- .040" contact diameter.
- Short rear insulator provides low profile on PCB.
- Offered with .120 mounting holes, dual float bushings, or optional 4-40 clinch nuts.

## Materials

- Contact Material: Socket - Phosphor bronze (machined), Plug - Brass (machined).
- Contact Plating: Gold flash or 30µin. gold over nickel.



## Ordering Information

### Vertical PCB Plugs

#### Zinc-Plated Shell with Yellow Chromate Finish

| Positions | Mounting Holes |             | 4-40 Clinch Nuts |             | Dual Float Bushings |             |
|-----------|----------------|-------------|------------------|-------------|---------------------|-------------|
|           | Gold Flash     | 30µin. Gold | Gold Flash       | 30µin. Gold | Gold Flash          | 30µin. Gold |
| 9         | DE-9PV         | DE-9PV-30   | DEE-9PV          | DEE-9PV-30  | DEY-9PV             | DEY-9PV-30  |
| 15        | DA-15PV        | DA-15PV-30  | DAE-15PV         | DAE-15PV-30 | DAY-15PV            | DAY-15PV-30 |
| 25        | DB-25PV        | DB-25PV-30  | DBE-25PV         | DBE-25PV-30 | DBY-25PV            | DBY-25PV-30 |
| 37        | DC-37PV        | DC-37PV-30  | DCE-37PV         | DCE-37PV-30 | DCY-37PV            | DCY-37PV-30 |
| 50        | DD-50PV        | DD-50PV-30  | DDE-50PV         | DDE-50PV-30 | DCY-50PV            | DDY-50PV-30 |

#### Tin-Plated Shell with Grounding Indents

| Positions | Mounting Holes |              | 4-40 Clinch Nuts |               | Dual Float Bushings |               |
|-----------|----------------|--------------|------------------|---------------|---------------------|---------------|
|           | Gold Flash     | 30µin. Gold  | Gold Flash       | 30µin. Gold   | Gold Flash          | 30µin. Gold   |
| 9         | DE-9PVTI       | DE-9PVTI-30  | DEE-9PVTI        | DEE-9PVTI-30  | DEY-9PVTI           | DEY-9PVTI-30  |
| 15        | DA-15PVTI      | DA-15PVTI-30 | DAE-15PVTI       | DAE-15PVTI-30 | DAY-15PVTI          | DAY-15PVTI-30 |
| 25        | DB-25PVTI      | DB-25PVTI-30 | DBE-25PVTI       | DBE-25PVTI-30 | DBY-25PVTI          | DBY-25PVTI-30 |
| 37        | DC-37PVTI      | DC-37PVTI-30 | DCE-37PVTI       | DCE-37PVTI-30 | DCY-37PVTI          | DCY-37PVTI-30 |
| 50        | DD-50PVTI      | DD-50PVTI-30 | DDE-50PVTI       | DDE-50PVTI-30 | DCY-50PVTI          | DDY-50PVTI-30 |

### Vertical PCB Sockets

#### Zinc-Plated Shell with Yellow Chromate Finish

| Positions | Mounting Holes |             | 4-40 Clinch Nuts |             | Dual Float Bushings |             |
|-----------|----------------|-------------|------------------|-------------|---------------------|-------------|
|           | Gold Flash     | 30µin. Gold | Gold Flash       | 30µin. Gold | Gold Flash          | 30µin. Gold |
| 9         | DE-9SV         | DE-9SV-30   | DEE-9SV          | DEE-9SV-30  | DEY-9SV             | DEY-9SV-30  |
| 15        | DA-15SV        | DA-15SV-30  | DAE-15SV         | DAE-15SV-30 | DAY-15SV            | DAY-15SV-30 |
| 25        | DB-25SV        | DB-25SV-30  | DBE-25SV         | DBE-25SV-30 | DBY-25SV            | DBY-25SV-30 |
| 37        | DC-37SV        | DC-37SV-30  | DCE-37SV         | DCE-37SV-30 | DCY-37SV            | DCY-37SV-30 |
| 50        | DD-50SV        | DD-50SV-30  | DDE-50SV         | DDE-50SV-30 | DCY-50SV            | DDY-50SV-30 |

#### Tin-Plated Shell

| Positions | Mounting Holes |             | 4-40 Clinch Nuts |              | Dual Float Bushings |              |
|-----------|----------------|-------------|------------------|--------------|---------------------|--------------|
|           | Gold Flash     | 30µin. Gold | Gold Flash       | 30µin. Gold  | Gold Flash          | 30µin. Gold  |
| 9         | DE-9SVT        | DE-9SVT-30  | DEE-9SVT         | DEE-9SVT-30  | DEY-9SVT            | DEY-9SVT-30  |
| 15        | DA-15SVT       | DA-15SVT-30 | DAE-15SVT        | DAE-15SVT-30 | DAY-15SVT           | DAY-15SVT-30 |
| 25        | DB-25SVT       | DB-25SVT-30 | DBE-25SVT        | DBE-25SVT-30 | DBY-25SVT           | DBY-25SVT-30 |
| 37        | DC-37SVT       | DC-37SVT-30 | DCE-37SVT        | DCE-37SVT-30 | DCY-37SVT           | DCY-37SVT-30 |
| 50        | DD-50SVT       | DD-50SVT-30 | DDE-50SVT        | DDE-50SVT-30 | DDY-50SVT           | DDY-50SVT-30 |

# D-subminiature Metal Shell Wire Wrap Basic D Series



- Reliable wire wrap termination.
- Two contact lengths: .375" or .585".
- .025" square contact tails.

## Materials

- Contact Material: Copper alloy (machined).
- Contact Plating: Gold flash or 30µin. gold. All over nickel.



## Ordering Information

### Wire Wrap Plugs

#### .375" Tail Length

#### Zinc-Plated Shell with Yellow Chromate Finish

| Positions | Mounting Holes |                | 4-40 Clinch Nuts |                 | Dual Float Bushings |                 |
|-----------|----------------|----------------|------------------|-----------------|---------------------|-----------------|
|           | Gold Flash     | 30µin. Gold    | Gold Flash       | 30µin. Gold     | Gold Flash          | 30µin. Gold     |
| 9         | DE-9P-F179     | DE-9P-F179-30  | DEE-9P-F179      | DEE-9P-F179-30  | DEY-9P-F179         | DEY-9P-F179-30  |
| 15        | DA-15P-F179    | DA-15P-F179-30 | DAE-15P-F179     | DAE-15P-F179-30 | DAY-15P-F179        | DAY-15P-F179-30 |
| 25        | DB-25P-F179    | DB-25P-F179-30 | DBE-25P-F179     | DBE-25P-F179-30 | DBY-25P-F179        | DBY-25P-F179-30 |
| 37        | DC-37P-F179    | DC-37P-F179-30 | DCE-37P-F179     | DCE-37P-F179-30 | DCY-37P-F179        | DCY-37P-F179-30 |
| 50        | DD-50P-F179    | DD-50P-F179-30 | DDE-50P-F179     | DDE-50P-F179-30 | DDY-50P-F179        | DDY-50P-F179-30 |

#### Tin-Plated Shell with Grounding Indents

| Positions | Mounting Holes |                  | 4-40 Clinch Nuts |                   | Dual Float Bushings |                   |
|-----------|----------------|------------------|------------------|-------------------|---------------------|-------------------|
|           | Gold Flash     | 30µin. Gold      | Gold Flash       | 30µin. Gold       | Gold Flash          | 30µin. Gold       |
| 9         | DE-9PTI-F179   | DE-9PTI-F179-30  | DEE-9PTI-F179    | DEE-9PTI-F179-30  | DEY-9PTI-F179       | DEY-9PTI-F179-30  |
| 15        | DA-15PTI-F179  | DA-15PTI-F179-30 | DAE-15PTI-F179   | DAE-15PTI-F179-30 | DAY-15PTI-F179      | DAY-15PTI-F179-30 |
| 25        | DB-25PTI-F179  | DB-25PTI-F179-30 | DBE-25PTI-F179   | DBE-25PTI-F179-30 | DBY-25PTI-F179      | DBY-25PTI-F179-30 |
| 37        | DC-37PTI-F179  | DC-37PTI-F179-30 | DCE-37PTI-F179   | DCE-37PTI-F179-30 | DCY-37PTI-F179      | DCY-37PTI-F179-30 |
| 50        | DD-50PTI-F179  | DD-50PTI-F179-30 | DDE-50PTI-F179   | DDE-50PTI-F179-30 | DDY-50PTI-F179      | DDY-50PTI-F179-30 |



# D-subminiature Metal Shell

## Wire Wrap

### Basic D Series



#### Ordering Information

#### Wire Wrap Plugs (Cont'd)

#### .585" Tail Length

#### Zinc-Plated Shell with Yellow Chromate Finish

| Positions | Mounting Holes |                 | 4-40 Clinch Nuts |                  | Dual Float Bushings |                  |
|-----------|----------------|-----------------|------------------|------------------|---------------------|------------------|
|           | Gold Flash     | 30µin. Gold     | Gold Flash       | 30µin. Gold      | Gold Flash          | 30µin. Gold      |
| 9         | DE-9P-F179C    | DE-9P-F179C-30  | DEE-9P-F179C     | DEE-9PF-179C-30  | DEY-9P-F179C        | DEY-9P-F179C-30  |
| 15        | DA-15P-F179C   | DA-15P-F179C-30 | DAE-15P-F179C    | DAE-15PF-179C-30 | DAY-15P-F179C       | DAY-15P-F179C-30 |
| 25        | DB-25P-F179C   | DB-25P-F179C-30 | DBE-25P-F179C    | DBE-25PF-179C-30 | DBY-25P-F179C       | DBY-25P-F179C-30 |
| 37        | DC-37P-F179C   | DC-37P-F179C-30 | DCE-37P-F179C    | DCE-37PF-179C-30 | DCY-37P-F179C       | DCY-37P-F179C-30 |
| 50        | DD-50P-F179C   | DD-50P-F179C-30 | DDE-50P-F179C    | DDE-50PF-179C-30 | DDY-50P-F179C       | DDY-50P-F179C-30 |

#### Tin-Plated Shell with Grounding Indents

| Positions | Mounting Holes |                   | 4-40 Clinch Nuts |                    | Dual Float Bushings |                    |
|-----------|----------------|-------------------|------------------|--------------------|---------------------|--------------------|
|           | Gold Flash     | 30µin. Gold       | Gold Flash       | 30µin. Gold        | Gold Flash          | 30µin. Gold        |
| 9         | DE-9PTI-F179C  | DE-9PTI-F179C-30  | DEE-9PTI-F179C   | DEE-9PTI-F179C-30  | DEY-9PTI-F179C      | DEY-9PTI-F179C-30  |
| 15        | DA-15PTI-F179C | DA-15PTI-F179C-30 | DAE-15PTI-F179C  | DAE-15PTI-F179C-30 | DAY-15PTI-F179C     | DAY-15PTI-F179C-30 |
| 25        | DB-25PTI-F179C | DB-25PTI-F179C-30 | DBE-25PTI-F179C  | DBE-25PTI-F179C-30 | DBY-25PTI-F179C     | DBY-25PTI-F179C-30 |
| 37        | DC-37PTI-F179C | DC-37PTI-F179C-30 | DCE-37PTI-F179C  | DCE-37PTI-F179C-30 | DCY-37PTI-F179C     | DCY-37PTI-F179C-30 |
| 50        | DD-50PTI-F179C | DD-50PTI-F179C-30 | DDE-50PTI-F179C  | DDE-50PTI-F179C-30 | DDY-50PTI-F179C     | DDY-50PTI-F179C-30 |

4

# D-subminiature Metal Shell

## Wire Wrap

### Basic D Series



#### Ordering Information

#### Wire Wrap Sockets

#### .375" Tail Length

##### Zinc-Plated Shell with Yellow Chromate Finish

| Positions | Mounting Holes |                | 4-40 Clinch Nuts |                 | Dual Float Bushings |                 |
|-----------|----------------|----------------|------------------|-----------------|---------------------|-----------------|
|           | Gold Flash     | 30µin. Gold    | Gold Flash       | 30µin. Gold     | Gold Flash          | 30µin. Gold     |
| 9         | DE-9S-F179     | DE-9S-F179-30  | DEE-9S-F179      | DEE-9S-F179-30  | DEY-9S-F179         | DEY-9S-F179-30  |
| 15        | DA-15S-F179    | DA-15S-F179-30 | DAE-15S-F179     | DAE-15S-F179-30 | DAY-15S-F179        | DAY-15S-F179-30 |
| 25        | DB-25S-F179    | DB-25S-F179-30 | DBE-25S-F179     | DBE-25S-F179-30 | DBY-25S-F179        | DBY-25S-F179-30 |
| 37        | DC-37S-F179    | DC-37S-F179-30 | DCE-37S-F179     | DCE-37S-F179-30 | DCY-37S-F179        | DCY-37S-F179-30 |
| 50        | DD-50S-F179    | DD-50S-F179-30 | DDE-50S-F179     | DDE-50S-F179-30 | DDY-50S-F179        | DDY-50S-F179-30 |

##### Tin-Plated Shell

| Positions | Mounting Holes |                 | 4-40 Clinch Nuts |                  | Dual Float Bushings |                  |
|-----------|----------------|-----------------|------------------|------------------|---------------------|------------------|
|           | Gold Flash     | 30µin. Gold     | Gold Flash       | 30µin. Gold      | Gold Flash          | 30µin. Gold      |
| 9         | DE-9ST-F179    | DE-9ST-F179-30  | DEE-9ST-F179     | DEE-9ST-F179-30  | DEY-9ST-F179        | DEY-9ST-F179-30  |
| 15        | DA-15ST-F179   | DA-15ST-F179-30 | DAE-15ST-F179    | DAE-15ST-F179-30 | DAY-15ST-F179       | DAY-15ST-F179-30 |
| 25        | DB-25ST-F179   | DB-25ST-F179-30 | DBE-25ST-F179    | DBE-25ST-F179-30 | DBY-25ST-F179       | DBY-25ST-F179-30 |
| 37        | DC-37ST-F179   | DC-37ST-F179-30 | DCE-37ST-F179    | DCE-37ST-F179-30 | DCY-37ST-F179       | DCY-37ST-F179-30 |
| 50        | DD-50ST-F179   | DD-50ST-F179-30 | DDE-50ST-F179    | DDE-50ST-F179-30 | DDY-50ST-F179       | DDY-50ST-F179-30 |

#### .585" Tail Length

##### Zinc-Plated Shell with Yellow Chromate Finish

| Positions | Mounting Holes |                 | 4-40 Clinch Nuts |                  | Dual Float Bushings |                  |
|-----------|----------------|-----------------|------------------|------------------|---------------------|------------------|
|           | Gold Flash     | 30µin. Gold     | Gold Flash       | 30µin. Gold      | Gold Flash          | 30µin. Gold      |
| 9         | DE-9S-F179C    | DE-9S-F179C-30  | DEE-9S-F179C     | DEE-9S-F179C-30  | DEY-9S-F179C        | DEY-9S-F179C-30  |
| 15        | DA-15S-F179C   | DA-15S-F179C-30 | DAE-15S-F179C    | DAE-15S-F179C-30 | DAY-15S-F179C       | DAY-15S-F179C-30 |
| 25        | DB-25S-F179C   | DB-25S-F179C-30 | DBE-25S-F179C    | DBE-25S-F179C-30 | DBY-25S-F179C       | DBY-25S-F179C-30 |
| 37        | DC-37S-F179C   | DC-37S-F179C-30 | DCE-37S-F179C    | DCE-37S-F179C-30 | DCY-37S-F179C       | DCY-37S-F179C-30 |
| 50        | DD-50S-F179C   | DD-50S-F179C-30 | DDE-50S-F179C    | DDE-50S-F179C-30 | DDY-50S-F179C       | DDY-50S-F179C-30 |

##### Tin-Plated Shell

| Positions | Mounting Holes |                  | 4-40 Clinch Nuts |                   | Dual Float Bushings |                   |
|-----------|----------------|------------------|------------------|-------------------|---------------------|-------------------|
|           | Gold Flash     | 30µin. Gold      | Gold Flash       | 30µin. Gold       | Gold Flash          | 30µin. Gold       |
| 9         | DE-9ST-F179C   | DE-9ST-F179C-30  | DEE-9ST-F179C    | DEE-9ST-F179C-30  | DEY-9ST-F179C       | DEY-9ST-F179C-30  |
| 15        | DA-15ST-F179C  | DA-15ST-F179C-30 | DAE-15ST-F179C   | DAE-15ST-F179C-30 | DAY-15ST-F179C      | DAY-15ST-F179C-30 |
| 25        | DB-25ST-F179C  | DB-25ST-F179C-30 | DBE-25ST-F179C   | DBE-25ST-F179C-30 | DBY-25ST-F179C      | DBY-25ST-F179C-30 |
| 37        | DC-37ST-F179C  | DC-37ST-F179C-30 | DCE-37ST-F179C   | DCE-37ST-F179C-30 | DCY-37ST-F179C      | DCY-37ST-F179C-30 |
| 50        | DD-50ST-F179C  | DD-50ST-F179C-30 | DDE-50ST-F179C   | DDE-50ST-F179C-30 | DDY-50ST-F179C      | DDY-50ST-F179C-30 |



# D-subminiature Metal Shell Solder Cup, Right-Angle, and Vertical PCB Series 1 - High Reliability



## FEATURES

- Available in vertical and right-angle dip solder PCB connectors and solder cup version for wire termination.
- Commercial version of M24308 military connectors with tin-plated or zinc-plated shell and 30µin. gold plating.
- Monoblock green diallyl phthalate insulator for improved electrical performance.
- Machined contacts for precision performance.
- Offered in 9, 15, 25, 37, and 50 (except right-angle version) position plugs and sockets.
- Offered with .120 mounting holes, 4-40 clinch nuts (except right-angle version), or dual float bushings (except right-angle version).
- Approvals:
  - UL Recognized - Files E170218 (UL1977) and E130965 (UL1863).
  - CSA Approved - File LR31996.
- See pages 4-5 thru 4-10 for standard dimensions, contact arrangements, and panel mounting specifications.

## MATERIALS

**Insulator Material:** Glass-filled diallyl phthalate (green)  
UL 94V-0 rated

**Connector Shell:** Steel with zinc plating and yellow chromate finish or tin plating (grounding indents on plug)

**Contact Material:** Plug - Brass (machined), Socket - Phosphor bronze (machined)

**Contact Plating:** 30µin. gold over nickel

**4-40 Clinch Nut:** Steel with cadmium plating and yellow chromate finish

**Dual Float Bushing:** Stainless steel, passivated



## ENVIRONMENTAL

**Operating Temperature:** -65°C to + 125°C

**Shock:** 50G peak per MIL-STD-202, Method 213, Condition G

**Vibration:** 12 cycles in three perpendicular directions @ 10-2000Hz, per MIL-STD-202, Method 204, Condition D

**Moisture Resistance:** 90-95% relative humidity @ 40°C for 96 hours per MIL-STD-202, Method 103



## ELECTRICAL

**Withstanding Voltage:** Minimum 1250V RMS @ sea level

**Current Rating:** 5 Amps

**Contact Resistance:** 2.7 milliohms maximum

**Insulation Resistance:** 5000 megohms maximum (initial);  
1000 megohms (minimum) after environmental testing



## MECHANICAL

**Individual Contact Insertion and Separation Force (minimum/maximum):** 0.7 oz./12 oz.

**Durability:** 500 mating cycles



# D-subminiature Metal Shell Solder Cup Series 1 - High Reliability



- Will accommodate up to 20 AWG wire.



## Ordering Information

### Solder Cup Plugs

| Positions | Zinc-Plated Shell with Yellow Chromate Finish |                 |                     | Tin-Plated Shell with Grounding Indents |                 |                     |
|-----------|---|-----------------|---------------------|---|-----------------|---------------------|
|           | Mounting Hole                                 | 4-40 Clinch Nut | Dual Float Bushings | Mounting Hole                           | 4-40 Clinch Nut | Dual Float Bushings |
| 9         | DEM-9P  | DEME-9P         | DEMY-9P             | DEM-9PTI                                | DEME-9PTI       | DEMY-9PTI           |
| 15        | DAM-15P                                       | DAME-15P        | DAMY-15P            | DAM-15PTI                               | DAME-15PTI      | DAMY-15PTI          |
| 25        | DBM-25P                                       | DBME-25P        | DBMY-25P            | DBM-25PTI                               | DBME-25PTI      | DBMY-25PTI          |
| 37        | DCM-37P                                       | DCME-37P        | DCMY-37P            | DCM-37PTI                               | DCME-37PTI      | DCMY-37PTI          |
| 50        | DDM-50P                                       | DDME-50P        | DDMY-50P            | DDM-50PTI                               | DDME-50PTI      | DDMY-50PTI          |

### Solder Cup Sockets

| Positions | Zinc-Plated Shell with Yellow Chromate Finish |                 |                     | Tin-Plated Shell |                 |                     |
|-----------|---|-----------------|---------------------|------------------|-----------------|---------------------|
|           | Mounting Hole                                 | 4-40 Clinch Nut | Dual Float Bushings | Mounting Hole    | 4-40 Clinch Nut | Dual Float Bushings |
| 9         | DEM-9S  | DEME-9S         | DEMY-9S             | DEM-9ST          | DEME-9ST        | DEMY-9ST            |
| 15        | DAM-15S                                       | DAME-15S        | DAMY-15S            | DAM-15ST         | DAME-15ST       | DAMY-15ST           |
| 25        | DBM-25S                                       | DBME-25S        | DBMY-25S            | DBM-25ST         | DBME-25ST       | DBMY-25ST           |
| 37        | DCM-37S                                       | DCME-37S        | DCMY-37S            | DCM-37ST         | DCME-37ST       | DCMY-37ST           |
| 50        | DDM-50S                                       | DDME-50S        | DDMY-50S            | DDM-50ST         | DDME-50ST       | DDMY-50ST           |

4

# D-subminiature Metal Shell Right-Angle Dip Solder PCB Series 1 - High Reliability



- .283" footprint uses minimal board space.
- Available with three contact tail lengths (.125", .158", and .185") and two contact diameters (.030" and .040").

## Materials

- Mounting bracket: Black nylon. Can be removed if necessary.



## 4

### Ordering Information

#### Right-Angle PCB Plugs

##### Zinc-Plated Shell with Yellow Chromate Finish

| Positions | .125 Tail Length      | .158 Tail Length      | .185 Tail Length      | .125 Tail Length      | .158 Tail Length      | .185 Tail Length      |
|-----------|-----------------------|-----------------------|-----------------------|-----------------------|-----------------------|-----------------------|
|           | .030 Contact Diameter | .030 Contact Diameter | .030 Contact Diameter | .040 Contact Diameter | .040 Contact Diameter | .040 Contact Diameter |
| 9         | DEM-9PD               | DEM-9PL               | DEM-9PS               | DEM-9PA               | DEM-9PG               | DEM-9PW               |
| 15        | DAM-15PD              | DAM-15PL              | DAM-15PS              | DAM-15PA              | DAM-15PG              | DAM-15PW              |
| 25        | DBM-25PD              | DBM-25PL              | DBM-25PS              | DBM-25PA              | DBM-25PG              | DBM-25PW              |
| 37        | DCM-37PD              | DCM-37PL              | DCM-37PS              | DCM-37PA              | DCM-37PG              | DCM-37PW              |

##### Tin-Plated Shell with Grounding Indents

| Positions | .125 Tail Length      | .158 Tail Length      | .185 Tail Length      | .125 Tail Length      | .158 Tail Length      | .185 Tail Length      |
|-----------|-----------------------|-----------------------|-----------------------|-----------------------|-----------------------|-----------------------|
|           | .030 Contact Diameter | .030 Contact Diameter | .030 Contact Diameter | .040 Contact Diameter | .040 Contact Diameter | .040 Contact Diameter |
| 9         | DEM-9PDTI             | DEM-9PLTI             | DEM-9PSTI             | DEM-9PATI             | DEM-9PGTI             | DEM-9PWTI             |
| 15        | DAM-15PDTI            | DAM-15PLTI            | DAM-15PSTI            | DAM-15PATI            | DAM-15PGTI            | DAM-15PWTI            |
| 25        | DBM-25PDTI            | DBM-25PLTI            | DBM-25PSTI            | DBM-25PATI            | DBM-25PGTI            | DBM-25PWTI            |
| 37        | DCM-37PDTI            | DCM-37PLTI            | DCM-37PSTI            | DCM-37PATI            | DCM-37PGTI            | DCM-37PWTI            |



# D-subminiature Metal Shell Right-Angle Dip Solder PCB Series 1 - High Reliability



## Ordering Information

### Right-Angle PCB Sockets

#### Zinc-Plated Shell with Yellow Chromate Finish

| Positions | .125 Tail Length      | .158 Tail Length      | .185 Tail Length      | .125 Tail Length      | .158 Tail Length      | .185 Tail Length      |
|-----------|-----------------------|-----------------------|-----------------------|-----------------------|-----------------------|-----------------------|
|           | .030 Contact Diameter | .030 Contact Diameter | .030 Contact Diameter | .040 Contact Diameter | .040 Contact Diameter | .040 Contact Diameter |
| 9         | DEM-9SD               | DEM-9SL               | DEM-9SS               | DEM-9SA               | DEM-9SG               | DEM-9SW               |
| 15        | DAM-15SD              | DAM-15SL              | DAM-15SS              | DAM-15SA              | DAM-15SG              | DAM-15SW              |
| 25        | DBM-25SD              | DBM-25SL              | DBM-25SS              | DBM-25SA              | DBM-25SG              | DBM-25SW              |
| 37        | DCM-37SD              | DCM-37SL              | DCM-37SS              | DCM-37SA              | DCM-37SG              | DCM-37SW              |

#### Tin-Plated Shell

| Positions | .125 Tail Length      | .158 Tail Length      | .185 Tail Length      | .125 Tail Length      | .158 Tail Length      | .185 Tail Length      |
|-----------|-----------------------|-----------------------|-----------------------|-----------------------|-----------------------|-----------------------|
|           | .030 Contact Diameter | .030 Contact Diameter | .030 Contact Diameter | .040 Contact Diameter | .040 Contact Diameter | .040 Contact Diameter |
| 9         | DEM-9SDT              | DEM-9SLT              | DEM-9SST              | DEM-9SAT              | DEM-9SGT              | DEM-9SWT              |
| 15        | DAM-15SDT             | DAM-15SLT             | DAM-15SST             | DAM-15SAT             | DAM-15SGT             | DAM-15SWT             |
| 25        | DBM-25SDT             | DBM-25SLT             | DBM-25SST             | DBM-25SAT             | DBM-25SGT             | DBM-25SWT             |
| 37        | DCM-37SDT             | DCM-37SLT             | DCM-37SST             | DCM-37SAT             | DCM-37SGT             | DCM-37SWT             |

# D-subminiature Metal Shell Vertical Dip Solder PCB Series 1 - High Reliability



- Available with three contact tail lengths (.125", .158", and .185") and two contact diameters (.030" and .040").



## Ordering Information

### Vertical PCB Plugs

#### Zinc-Plated Shell with Yellow Chromate Finish

| Positions | .125 Tail Length      | .158 Tail Length      | .185 Tail Length      | .125 Tail Length      | .158 Tail Length      | .185 Tail Length      |
|-----------|-----------------------|-----------------------|-----------------------|-----------------------|-----------------------|-----------------------|
|           | .030 Contact Diameter | .030 Contact Diameter | .030 Contact Diameter | .040 Contact Diameter | .040 Contact Diameter | .040 Contact Diameter |
| 9         | DEM-9PE               | DEM-9PM               | DEM-9PZ               | DEM-9PB               | DEM-9PH               | DEM-9PX               |
| 15        | DAM-15PE              | DAM-15PM              | DAM-15PZ              | DAM-15PB              | DAM-15PH              | DAM-15PX              |
| 25        | DBM-25PE              | DBM-25PM              | DBM-25PZ              | DBM-25PB              | DBM-25PH              | DBM-25PX              |
| 37        | DCM-37PE              | DCM-37PM              | DCM-37PZ              | DCM-37PB              | DCM-37PH              | DCM-37PX              |
| 50        | DDM-50PE              | DDM-50PM              | DDM-50PZ              | DDM-50PB              | DDM-50PH              | DDM-50PX              |

#### Zinc-Plated Shell with Yellow Chromate Finish and 4-40 Clinch Nuts

| Positions | .125 Tail Length      | .158 Tail Length      | .185 Tail Length      | .125 Tail Length      | .158 Tail Length      | .185 Tail Length      |
|-----------|-----------------------|-----------------------|-----------------------|-----------------------|-----------------------|-----------------------|
|           | .030 Contact Diameter | .030 Contact Diameter | .030 Contact Diameter | .040 Contact Diameter | .040 Contact Diameter | .040 Contact Diameter |
| 9         | DEME-9PE              | DEME-9PM              | DEME-9PZ              | DEME-9PB              | DEME-9PH              | DEME-9PX              |
| 15        | DAME-15PE             | DAME-15PM             | DAME-15PZ             | DAME-15PB             | DAME-15PH             | DAME-15PX             |
| 25        | DBME-25PE             | DBME-25PM             | DBME-25PZ             | DBME-25PB             | DBME-25PH             | DBME-25PX             |
| 37        | DCME-37PE             | DCME-37PM             | DCME-37PZ             | DCME-37PB             | DCME-37PH             | DCME-37PX             |
| 50        | DDME-50PE             | DDME-50PM             | DDME-50PZ             | DDME-50PB             | DDME-50PH             | DDME-50PX             |

#### Zinc-Plated Shell with Yellow Chromate Finish and Dual Float Bushings

| Positions | .125 Tail Length      | .158 Tail Length      | .185 Tail Length      | .125 Tail Length      | .158 Tail Length      | .185 Tail Length      |
|-----------|-----------------------|-----------------------|-----------------------|-----------------------|-----------------------|-----------------------|
|           | .030 Contact Diameter | .030 Contact Diameter | .030 Contact Diameter | .040 Contact Diameter | .040 Contact Diameter | .040 Contact Diameter |
| 9         | DEMY-9PE              | DEMY-9PM              | DEMY-9PZ              | DEMY-9PB              | DEMY-9PH              | DEMY-9PX              |
| 15        | DAMY-15PE             | DAMY-15PM             | DAMY-15PZ             | DAMY-15PB             | DAMY-15PH             | DAMY-15PX             |
| 25        | DBMY-25PE             | DBMY-25PM             | DBMY-25PZ             | DBMY-25PB             | DBMY-25PH             | DBMY-25PX             |
| 37        | DCMY-37PE             | DCMY-37PM             | DCMY-37PZ             | DCMY-37PB             | DCMY-37PH             | DCMY-37PX             |
| 50        | DDMY-50PE             | DDMY-50PM             | DDMY-50PZ             | DDMY-50PB             | DDMY-50PH             | DDMY-50PX             |

# D-subminiature Metal Shell Vertical Dip Solder PCB Series 1 - High Reliability



## Ordering Information

### Vertical PCB Plugs (Cont'd)

#### Tin-Plated Shell with Grounding Indents

| Positions | .125 Tail Length<br>.030 Contact<br>Diameter | .158 Tail Length<br>.030 Contact<br>Diameter | .185 Tail Length<br>.030 Contact<br>Diameter | .125 Tail Length<br>.040 Contact<br>Diameter | .158 Tail Length<br>.040 Contact<br>Diameter | .185 Tail Length<br>.040 Contact<br>Diameter |
|-----------|--|--|--|--|--|--|
| 9         | DEM-9PETI                                    | DEM-9PMTI                                    | DEM-9PZTI                                    | DEM-9PBTI                                    | DEM-9PHTI                                    | DEM-9PXTI                                    |
| 15        | DAM-15PETI                                   | DAM-15PMTI                                   | DAM-15PZTI                                   | DAM-15PBTI                                   | DAM-15PHTI                                   | DAM-15PXTI                                   |
| 25        | DBM-25PETI                                   | DBM-25PMTI                                   | DBM-25PZTI                                   | DBM-25PBTI                                   | DBM-25PHTI                                   | DBM-25PXTI                                   |
| 37        | DCM-37PETI                                   | DCM-37PMTI                                   | DCM-37PZTI                                   | DCM-37PBTI                                   | DCM-37PHTI                                   | DCM-37PXTI                                   |
| 50        | DDM-50PETI                                   | DDM-50PMTI                                   | DDM-50PZTI                                   | DDM-50PBTI                                   | DDM-50PHTI                                   | DDM-50PXTI                                   |

#### Tin-Plated Shell with Grounding Indents and 4-40 Clinch Nuts

| Positions | .125 Tail Length<br>.030 Contact<br>Diameter | .158 Tail Length<br>.030 Contact<br>Diameter | .185 Tail Length<br>.030 Contact<br>Diameter | .125 Tail Length<br>.040 Contact<br>Diameter | .158 Tail Length<br>.040 Contact<br>Diameter | .185 Tail Length<br>.040 Contact<br>Diameter |
|-----------|--|--|--|--|--|--|
| 9         | DEME-9PETI                                   | DEME-9PMTI                                   | DEME-9PZTI                                   | DEME-9PBTI                                   | DEME-9PHTI                                   | DEME-9PXTI                                   |
| 15        | DAME-15PETI                                  | DAME-15PMTI                                  | DAME-15PZTI                                  | DAME-15PBTI                                  | DAME-15PHTI                                  | DAME-15PXTI                                  |
| 25        | DBME-25PETI                                  | DBME-25PMTI                                  | DBME-25PZTI                                  | DBME-25PBTI                                  | DBME-25PHTI                                  | DBME-25PXTI                                  |
| 37        | DCME-37PETI                                  | DCME-37PMTI                                  | DCME-37PZTI                                  | DCME-37PBTI                                  | DCME-37PHTI                                  | DCME-37PXTI                                  |
| 50        | DDME-50PETI                                  | DDME-50PMTI                                  | DDME-50PZTI                                  | DDME-50PBTI                                  | DDME-50PHTI                                  | DDME-50PXTI                                  |

#### Tin-Plated Shell with Grounding Indents and Dual Float Bushings

| Positions | .125 Tail Length<br>.030 Contact<br>Diameter | .158 Tail Length<br>.030 Contact<br>Diameter | .185 Tail Length<br>.030 Contact<br>Diameter | .125 Tail Length<br>.040 Contact<br>Diameter | .158 Tail Length<br>.040 Contact<br>Diameter | .185 Tail Length<br>.040 Contact<br>Diameter |
|-----------|--|--|--|--|--|--|
| 9         | DEMY-9PETI                                   | DEMY-9PMTI                                   | DEMY-9PZTI                                   | DEMY-9PBTI                                   | DEMY-9PHTI                                   | DEMY-9PXTI                                   |
| 15        | DAMY-15PETI                                  | DAMY-15PMTI                                  | DAMY-15PZTI                                  | DAMY-15PBTI                                  | DAMY-15PHTI                                  | DAMY-15PXTI                                  |
| 25        | DBMY-25PETI                                  | DBMY-25PMTI                                  | DBMY-25PZTI                                  | DBMY-25PBTI                                  | DBMY-25PHTI                                  | DBMY-25PXTI                                  |
| 37        | DCMY-37PETI                                  | DCMY-37PMTI                                  | DCMY-37PZTI                                  | DCMY-37PBTI                                  | DCMY-37PHTI                                  | DCMY-37PXTI                                  |
| 50        | DDMY-50PETI                                  | DDMY-50PMTI                                  | DDMY-50PZTI                                  | DDMY-50PBTI                                  | DDMY-50PHTI                                  | DDMY-50PXTI                                  |

### Vertical PCB Sockets

#### Zinc-Plated Shell with Yellow Chromate Finish

| Positions | .125 Tail Length<br>.030 Contact<br>Diameter | .158 Tail Length<br>.030 Contact<br>Diameter | .185 Tail Length<br>.030 Contact<br>Diameter | .125 Tail Length<br>.040 Contact<br>Diameter | .158 Tail Length<br>.040 Contact<br>Diameter | .185 Tail Length<br>.040 Contact<br>Diameter |
|-----------|--|--|--|--|--|--|
| 9         | DEM-9SE                                      | DEM-9SM                                      | DEM-9SZ                                      | DEM-9SB                                      | DEM-9SH                                      | DEM-9SX                                      |
| 15        | DAM-15SE                                     | DAM-15SM                                     | DAM-15SZ                                     | DAM-15SB                                     | DAM-15SH                                     | DAM-15SX                                     |
| 25        | DBM-25SE                                     | DBM-25SM                                     | DBM-25SZ                                     | DBM-25SB                                     | DBM-25SH                                     | DBM-25SX                                     |
| 37        | DCM-37SE                                     | DCM-37SM                                     | DCM-37SZ                                     | DCM-37SB                                     | DCM-37SH                                     | DCM-37SX                                     |
| 50        | DDM-50SE                                     | DDM-50SM                                     | DDM-50SZ                                     | DDM-50SB                                     | DDM-50SH                                     | DDM-50SX                                     |

# D-subminiature Metal Shell Vertical Dip Solder PCB Series 1 - High Reliability



## Ordering Information

### Vertical PCB Sockets (Cont'd)

#### Zinc-Plated Shell with Yellow Chromate Finish and 4-40 Clinch Nuts

| Positions | .125 Tail Length      | .158 Tail Length      | .185 Tail Length      | .125 Tail Length      | .158 Tail Length      | .185 Tail Length      |
|-----------|-----------------------|-----------------------|-----------------------|-----------------------|-----------------------|-----------------------|
|           | .030 Contact Diameter | .030 Contact Diameter | .030 Contact Diameter | .040 Contact Diameter | .040 Contact Diameter | .040 Contact Diameter |
| 9         | DEME-9SE              | DEME-9SM              | DEME-9SZ              | DEME-9SB              | DEME-9SH              | DEME-9SX              |
| 15        | DAME-15SE             | DAME-15SM             | DAME-15SZ             | DAME-15SB             | DAME-15SH             | DAME-15SX             |
| 25        | DBME-25SE             | DBME-25SM             | DBME-25SZ             | DBME-25SB             | DBME-25SH             | DBME-25SX             |
| 37        | DCME-37SE             | DCME-37SM             | DCME-37SZ             | DCME-37SB             | DCME-37SH             | DCME-37SX             |
| 50        | DDME-50SE             | DDME-50SM             | DDME-50SZ             | DDME-50SB             | DDME-50SH             | DDME-50SX             |

#### Zinc-Plated Shell with Yellow Chromate Finish and Dual Float Bushings

| Positions | .125 Tail Length      | .158 Tail Length      | .185 Tail Length      | .125 Tail Length      | .158 Tail Length      | .185 Tail Length      |
|-----------|-----------------------|-----------------------|-----------------------|-----------------------|-----------------------|-----------------------|
|           | .030 Contact Diameter | .030 Contact Diameter | .030 Contact Diameter | .040 Contact Diameter | .040 Contact Diameter | .040 Contact Diameter |
| 9         | DEMY-9SE              | DEMY-9SM              | DEMY-9SZ              | DEMY-9SB              | DEMY-9SH              | DEMY-9SX              |
| 15        | DAMY-15SE             | DAMY-15SM             | DAMY-15SZ             | DAMY-15SB             | DAMY-15SH             | DAMY-15SX             |
| 25        | DBMY-25SE             | DBMY-25SM             | DBMY-25SZ             | DBMY-25SB             | DBMY-25SH             | DBMY-25SX             |
| 37        | DCMY-37SE             | DCMY-37SM             | DCMY-37SZ             | DCMY-37SB             | DCMY-37SH             | DCMY-37SX             |
| 50        | DDMY-50SE             | DDMY-50SM             | DDMY-50SZ             | DDMY-50SB             | DDMY-50SH             | DDMY-50SX             |

#### Tin-Plated Shell

| Positions | .125 Tail Length      | .158 Tail Length      | .185 Tail Length      | .125 Tail Length      | .158 Tail Length      | .185 Tail Length      |
|-----------|-----------------------|-----------------------|-----------------------|-----------------------|-----------------------|-----------------------|
|           | .030 Contact Diameter | .030 Contact Diameter | .030 Contact Diameter | .040 Contact Diameter | .040 Contact Diameter | .040 Contact Diameter |
| 9         | DEM-9SET              | DEM-9SMT              | DEM-9SZT              | DEM-9SBT              | DEM-9SHT              | DEM-9SXT              |
| 15        | DAM-15SET             | DAM-15SMT             | DAM-15SZT             | DAM-15SBT             | DAM-15SHT             | DAM-15SXT             |
| 25        | DBM-25SET             | DBM-25SMT             | DBM-25SZT             | DBM-25SBT             | DBM-25SHT             | DBM-25SXT             |
| 37        | DCM-37SET             | DCM-37SMT             | DCM-37SZT             | DCM-37SBT             | DCM-37SHT             | DCM-37SXT             |
| 50        | DDM-50SET             | DDM-50SMT             | DDM-50SZT             | DDM-50SBT             | DDM-50SHT             | DDM-50SXT             |

#### Tin-Plated Shell with 4-40 Clinch Nuts

| Positions | .125 Tail Length      | .158 Tail Length      | .185 Tail Length      | .125 Tail Length      | .158 Tail Length      | .185 Tail Length      |
|-----------|-----------------------|-----------------------|-----------------------|-----------------------|-----------------------|-----------------------|
|           | .030 Contact Diameter | .030 Contact Diameter | .030 Contact Diameter | .040 Contact Diameter | .040 Contact Diameter | .040 Contact Diameter |
| 9         | DEME-9SET             | DEME-9SMT             | DEME-9SZT             | DEME-9SBT             | DEME-9SHT             | DEME-9SXT             |
| 15        | DAME-15SET            | DAME-15SMT            | DAME-15SZT            | DAME-15SBT            | DAME-15SHT            | DAME-15SXT            |
| 25        | DBME-25SET            | DBME-25SMT            | DBME-25SZT            | DBME-25SBT            | DBME-25SHT            | DBME-25SXT            |
| 37        | DCME-37SET            | DCME-37SMT            | DCME-37SZT            | DCME-37SBT            | DCME-37SHT            | DCME-37SXT            |
| 50        | DDME-50SET            | DDME-50SMT            | DDME-50SZT            | DDME-50SBT            | DDME-50SHT            | DDME-50SXT            |

#### Tin-Plated Shell with Dual Float Bushings

| Positions | .125 Tail Length      | .158 Tail Length      | .185 Tail Length      | .125 Tail Length      | .158 Tail Length      | .185 Tail Length      |
|-----------|-----------------------|-----------------------|-----------------------|-----------------------|-----------------------|-----------------------|
|           | .030 Contact Diameter | .030 Contact Diameter | .030 Contact Diameter | .040 Contact Diameter | .040 Contact Diameter | .040 Contact Diameter |
| 9         | DEMY-9SET             | DEMY-9SMT             | DEMY-9SZT             | DEMY-9SBT             | DEMY-9SHT             | DEMY-9SXT             |
| 15        | DAMY-15SET            | DAMY-15SMT            | DAMY-15SZT            | DAMY-15SBT            | DAMY-15SHT            | DAMY-15SXT            |
| 25        | DBMY-25SET            | DBMY-25SMT            | DBMY-25SZT            | DBMY-25SBT            | DBMY-25SHT            | DBMY-25SXT            |
| 37        | DCMY-37SET            | DCMY-37SMT            | DCMY-37SZT            | DCMY-37SBT            | DCMY-37SHT            | DCMY-37SXT            |
| 50        | DDMY-50SET            | DDMY-50SMT            | DDMY-50SZT            | DDMY-50SBT            | DDMY-50SHT            | DDMY-50SXT            |

# D-subminiature Metal Shell - Combination Layout Solder Cup and Vertical PCB Series 1 - High Reliability



- Shell Sizes (equivalent to standard size): E (Size 9), A (Size 15 ), B (Size 25 ), C (Size 25 ), and D (Size 25 ).
- Offered in a variety of combination layouts in vertical style for PCB mount or solder cup style for wire termination.
- Signal Contacts (Size 20) are fixed and non-removable.
  - Vertical Dip Solder Contacts are available with three contact tail lengths (.125", .158", and .185") and two contact diameters (.030" and .040").
- Removable Coaxial, High Power, High Voltage contacts must be ordered separately.
- See Series 1 page 4-48 for specifications.
- Available with 30µin. or 50µin. gold contact plating.

## Materials

Connector Shell:

- Steel with zinc or cadmium plating and yellow chromate finish or tin plating (grounding indents on plug).



# D-subminiature Metal Shell - Combination Layout Series 1 - High Reliability



## Combination Layouts



|                     |     |     |     |      |
|---------------------|-----|-----|-----|------|
| Shell Size          | E   | A   | A   | A    |
| Contact Arrangement | 5W1 | 3W3 | 7W2 | 11W1 |
| Signal Contacts     | 4   | 0   | 5   | 10   |
| Coax Cavities       | 1   | 1   | 1   | 1    |



|                     |     |      |      |      |
|---------------------|-----|------|------|------|
| Shell Size          | B   | B    | B    | B    |
| Contact Arrangement | 9W4 | 13W3 | 17W2 | 21W1 |
| Signal Contacts     | 5   | 10   | 15   | 20   |
| Coax Cavities       | 4   | 3    | 2    | 1    |



|                     |      |     |      |
|---------------------|------|-----|------|
| Shell Size          | C    | C   | C    |
| Contact Arrangement | 13W6 | 8W8 | 17W5 |
| Signal Contacts     | 7    | 0   | 12   |
| Coax Cavities       | 5    | 8   | 5    |



|                     |        |      |      |
|---------------------|--------|------|------|
| Shell Size          | C      | C    | C    |
| Contact Arrangement | 21WA-4 | 25W3 | 27W2 |
| Signal Contacts     | 17     | 22   | 25   |
| Coax Cavities       | 4      | 3    | 2    |



|                     |      |      |      |
|---------------------|------|------|------|
| Shell Size          | D    | D    | D    |
| Contact Arrangement | 24W7 | 36W4 | 43W2 |
| Signal Contacts     | 25   | 32   | 41   |
| Coax Cavities       | 2    | 4    | 2    |

NOTE: Mating face of plug is shown, socket is mirror image. Position numbers are for male only.

# D-subminiature Metal Shell - Combination Layout Solder Cup Series 1 - High Reliability



- Will accommodate up to 20 AWG wire.



## Ordering Information

### Combo D-sub Solder Cup Plugs

30µin. Gold Plating

| Shell Size | Zinc-Plated Shell with Yellow Chromate Finish |                  |                     | Tin-Plated Shell with Grounding Indents |                  |                     |
|------------|---|------------------|---------------------|---|------------------|---------------------|
|            | Mounting Holes                                | 4-40 Clinch Nuts | Dual Float Bushings | Mounting Holes                          | 4-40 Clinch Nuts | Dual Float Bushings |
| E          | DEM-XXWX*P                                    | DEME-XXWX*P      | DEMY-XXWX*P         | DEM-XXWX*PTI                            | DEME-XXWX*PTI    | DEMY-XXWX*PTI       |
| A          | DAM-XXWX*P                                    | DAME-XXWX*P      | DAMY-XXWX*P         | DAM-XXWX*PTI                            | DAME-XXWX*PTI    | DAMY-XXWX*PTI       |
| B          | DBM-XXWX*P                                    | DBME-XXWX*P      | DBMY-XXWX*P         | DBM-XXWX*PTI                            | DBME-XXWX*PTI    | DBMY-XXWX*PTI       |
| C          | DCM-XXWX*P                                    | DCME-XXWX*P      | DCMY-XXWX*P         | DCM-XXWX*PTI                            | DCME-XXWX*PTI    | DCMY-XXWX*PTI       |
| D          | DDM-XXWX*P                                    | DDME-XXWX*P      | DDMY-XXWX*P         | DDM-XXWX*PTI                            | DDME-XXWX*PTI    | DDMY-XXWX*PTI       |

### Combo D-sub Solder Cup Sockets

30µin. Gold Plating

| Shell Size | Zinc-Plated Shell with Yellow Chromate Finish |                  |                     | Tin-Plated Shell |                  |                     |
|------------|---|------------------|---------------------|------------------|------------------|---------------------|
|            | Mounting Holes                                | 4-40 Clinch Nuts | Dual Float Bushings | Mounting Holes   | 4-40 Clinch Nuts | Dual Float Bushings |
| E          | DEM-XXWX*S                                    | DEME-XXWX*S      | DEMY-XXWX*S         | DEM-XXWX*ST      | DEME-XXWX*ST     | DEMY-XXWX*ST        |
| A          | DAM-XXWX*S                                    | DAME-XXWX*S      | DAMY-XXWX*S         | DAM-XXWX*ST      | DAME-XXWX*ST     | DAMY-XXWX*ST        |
| B          | DBM-XXWX*S                                    | DBME-XXWX*S      | DBMY-XXWX*S         | DBM-XXWX*ST      | DBME-XXWX*ST     | DBMY-XXWX*ST        |
| C          | DCM-XXWX*S                                    | DCME-XXWX*S      | DCMY-XXWX*S         | DCM-XXWX*ST      | DCME-XXWX*ST     | DCMY-XXWX*ST        |
| D          | DDM-XXWX*S                                    | DDME-XXWX*S      | DDMY-XXWX*S         | DDM-XXWX*ST      | DDME-XXWX*ST     | DDMY-XXWX*ST        |

### Combo D-sub Solder Cup Plugs and Sockets

50µin. Gold Plating

#### Cadmium-Plated Shell with Yellow Chromate Finish

| Shell Size | Plugs          |                  |                     | Sockets        |                  |                     |
|------------|----------------|------------------|---------------------|----------------|------------------|---------------------|
|            | Mounting Holes | 4-40 Clinch Nuts | Dual Float Bushings | Mounting Holes | 4-40 Clinch Nuts | Dual Float Bushings |
| E          | DEMM-XXWX*P    | DEMME-XXWX*P     | DEMMY-XXWX*P        | DEMM-XXWX*S    | DEMME-XXWX*S     | DEMMY-XXWX*S        |
| A          | DAMM-XXWX*P    | DAMME-XXWX*P     | DAMMY-XXWX*P        | DAMM-XXWX*S    | DAMME-XXWX*S     | DAMMY-XXWX*S        |
| B          | DBMM-XXWX*P    | DBMME-XXWX*P     | DBMMY-XXWX*P        | DBMM-XXWX*S    | DBMME-XXWX*S     | DBMMY-XXWX*S        |
| C          | DCMM-XXWX*P    | DCMME-XXWX*P     | DCMMY-XXWX*P        | DCMM-XXWX*S    | DCMME-XXWX*S     | DCMMY-XXWX*S        |
| D          | DDMM-XXWX*P    | DDMME-XXWX*P     | DDMMY-XXWX*P        | DDMM-XXWX*S    | DDMME-XXWX*S     | DDMMY-XXWX*S        |

\*Note: XXWX means insert combo layout contact arrangement from page 4-56 in catalog number i.e., 13W3.

# D-subminiature Metal Shell - Combination Layout

## Vertical PCB Dip Solder Tails

### Series 1 - High Reliability



#### Ordering Information

#### Combo D-sub Vertical PCB Plugs

#### 30µin. Gold Plating

#### Zinc-Plated Shell with Yellow Chromate Finish and Mounting Holes

| Shell Size | .125 Tail Length<br>.030 Contact<br>Diameter | .158 Tail Length<br>.030 Contact<br>Diameter | .185 Tail Length<br>.030 Contact<br>Diameter | .125 Tail Length<br>.040 Contact<br>Diameter | .158 Tail Length<br>.040 Contact<br>Diameter | .185 Tail Length<br>.040 Contact<br>Diameter |
|------------|--|--|--|--|--|--|
| E          | DEM-XXWX*PE                                  | DEM-XXWX*PM                                  | DEM-XXWX*PZ                                  | DEM-XXWX*PB                                  | DEM-XXWX*PH                                  | DEM-XXWX*PX                                  |
| A          | DAM-XXWX*PE                                  | DAM-XXWX*PM                                  | DAM-XXWX*PZ                                  | DAM-XXWX*PB                                  | DAM-XXWX*PH                                  | DAM-XXWX*PX                                  |
| B          | DBM-XXWX*PE                                  | DBM-XXWX*PM                                  | DBM-XXWX*PZ                                  | DBM-XXWX*PB                                  | DBM-XXWX*PH                                  | DBM-XXWX*PX                                  |
| C          | DCM-XXWX*PE                                  | DCM-XXWX*PM                                  | DCM-XXWX*PZ                                  | DCM-XXWX*PB                                  | DCM-XXWX*PH                                  | DCM-XXWX*PX                                  |
| D          | DDM-XXWX*PE                                  | DDM-XXWX*PM                                  | DDM-XXWX*PZ                                  | DDM-XXWX*PB                                  | DDM-XXWX*PH                                  | DDM-XXWX*PX                                  |

#### Zinc-Plated Shell with Yellow Chromate Finish and 4-40 Clinch Nuts

| Shell Size | .125 Tail Length<br>.030 Contact<br>Diameter | .158 Tail Length<br>.030 Contact<br>Diameter | .185 Tail Length<br>.030 Contact<br>Diameter | .125 Tail Length<br>.040 Contact<br>Diameter | .158 Tail Length<br>.040 Contact<br>Diameter | .185 Tail Length<br>.040 Contact<br>Diameter |
|------------|--|--|--|--|--|--|
| E          | DEME-XXWX*PE                                 | DEME-XXWX*PM                                 | DEME-XXWX*PZ                                 | DEME-XXWX*PB                                 | DEME-XXWX*PH                                 | DEME-XXWX*PX                                 |
| A          | DAME-XXWX*PE                                 | DAME-XXWX*PM                                 | DAME-XXWX*PZ                                 | DAME-XXWX*PB                                 | DAME-XXWX*PH                                 | DAME-XXWX*PX                                 |
| B          | DBME-XXWX*PE                                 | DBME-XXWX*PM                                 | DBME-XXWX*PZ                                 | DBME-XXWX*PB                                 | DBME-XXWX*PH                                 | DBME-XXWX*PX                                 |
| C          | DCME-XXWX*PE                                 | DCME-XXWX*PM                                 | DCME-XXWX*PZ                                 | DCME-XXWX*PB                                 | DCME-XXWX*PH                                 | DCME-XXWX*PX                                 |
| D          | DDME-XXWX*PE                                 | DDME-XXWX*PM                                 | DDME-XXWX*PZ                                 | DDME-XXWX*PB                                 | DDME-XXWX*PH                                 | DDME-XXWX*PX                                 |

#### Zinc-Plated Shell with Yellow Chromate Finish and Dual Float Bushings

| Shell Size | .125 Tail Length<br>.030 Contact<br>Diameter | .158 Tail Length<br>.030 Contact<br>Diameter | .185 Tail Length<br>.030 Contact<br>Diameter | .125 Tail Length<br>.040 Contact<br>Diameter | .158 Tail Length<br>.040 Contact<br>Diameter | .185 Tail Length<br>.040 Contact<br>Diameter |
|------------|--|--|--|--|--|--|
| E          | DEMY-XXWX*PE                                 | DEMY-XXWX*PM                                 | DEMY-XXWX*PZ                                 | DEMY-XXWX*PB                                 | DEMY-XXWX*PH                                 | DEMY-XXWX*PX                                 |
| A          | DAMY-XXWX*PE                                 | DAMY-XXWX*PM                                 | DAMY-XXWX*PZ                                 | DAMY-XXWX*PB                                 | DAMY-XXWX*PH                                 | DAMY-XXWX*PX                                 |
| B          | DBMY-XXWX*PE                                 | DBMY-XXWX*PM                                 | DBMY-XXWX*PZ                                 | DBMY-XXWX*PB                                 | DBMY-XXWX*PH                                 | DBMY-XXWX*PX                                 |
| C          | DCMY-XXWX*PE                                 | DCMY-XXWX*PM                                 | DCMY-XXWX*PZ                                 | DCMY-XXWX*PB                                 | DCMY-XXWX*PH                                 | DCMY-XXWX*PX                                 |
| D          | DDMY-XXWX*PE                                 | DDMY-XXWX*PM                                 | DDMY-XXWX*PZ                                 | DDMY-XXWX*PB                                 | DDMY-XXWX*PH                                 | DDMY-XXWX*PX                                 |

#### Tin-Plated Shell with Grounding Indents and Mounting Holes

| Shell Size | .125 Tail Length<br>.030 Contact<br>Diameter | .158 Tail Length<br>.030 Contact<br>Diameter | .185 Tail Length<br>.030 Contact<br>Diameter | .125 Tail Length<br>.040 Contact<br>Diameter | .158 Tail Length<br>.040 Contact<br>Diameter | .185 Tail Length<br>.040 Contact<br>Diameter |
|------------|--|--|--|--|--|--|
| E          | DEM-XXWX*PETI                                | DEM-XXWX*PMTI                                | DEM-XXWX*PZTI                                | DEM-XXWX*PBTI                                | DEM-XXWX*PHTI                                | DEM-XXWX*PXTI                                |
| A          | DAM-XXWX*PETI                                | DAM-XXWX*PMTI                                | DAM-XXWX*PZTI                                | DAM-XXWX*PBTI                                | DAM-XXWX*PHTI                                | DAM-XXWX*PXTI                                |
| B          | DBM-XXWX*PETI                                | DBM-XXWX*PMTI                                | DBM-XXWX*PZTI                                | DBM-XXWX*PBTI                                | DBM-XXWX*PHTI                                | DBM-XXWX*PXTI                                |
| C          | DCM-XXWX*PETI                                | DCM-XXWX*PMTI                                | DCM-XXWX*PZTI                                | DCM-XXWX*PBTI                                | DCM-XXWX*PHTI                                | DCM-XXWX*PXTI                                |
| D          | DDM-XXWX*PETI                                | DDM-XXWX*PMTI                                | DDM-XXWX*PZTI                                | DDM-XXWX*PBTI                                | DDM-XXWX*PHTI                                | DDM-XXWX*PXTI                                |

\* Note: XXWX means insert combo layout contact arrangement from page 4-56 in catalog number i.e., 13W3.



# D-subminiature Metal Shell - Combination Layout

## Vertical PCB Dip Solder Tails

### Series 1 - High Reliability



#### Ordering Information

#### Combo D-sub Vertical PCB Plugs

#### 30µin. Gold Plating (Cont'd)

##### Tin-Plated Shell with Grounding Indents and 4-40 Clinch Nuts

| Shell Size | .125 Tail Length<br>.030 Contact<br>Diameter | .158 Tail Length<br>.030 Contact<br>Diameter | .185 Tail Length<br>.030 Contact<br>Diameter | .125 Tail Length<br>.040 Contact<br>Diameter | .158 Tail Length<br>.040 Contact<br>Diameter | .185 Tail Length<br>.040 Contact<br>Diameter |
|------------|--|--|--|--|--|--|
| E          | DEME-XXWX*PETI                               | DEME-XXWX*PMTI                               | DEME-XXWX*PZTI                               | DEME-XXWX*PBTI                               | DEME-XXWX*PHTI                               | DEME-XXWX*PXTI                               |
| A          | DAME-XXWX*PETI                               | DAME-XXWX*PMTI                               | DAME-XXWX*PZTI                               | DAME-XXWX*PBTI                               | DAME-XXWX*PHTI                               | DAME-XXWX*PXTI                               |
| B          | DBME-XXWX*PETI                               | DBME-XXWX*PMTI                               | DBME-XXWX*PZTI                               | DBME-XXWX*PBTI                               | DBME-XXWX*PHTI                               | DBME-XXWX*PXTI                               |
| C          | DCME-XXWX*PETI                               | DCME-XXWX*PMTI                               | DCME-XXWX*PZTI                               | DCME-XXWX*PBTI                               | DCME-XXWX*PHTI                               | DCME-XXWX*PXTI                               |
| D          | DDME-XXWX*PETI                               | DDME-XXWX*PMTI                               | DDME-XXWX*PZTI                               | DDME-XXWX*PBTI                               | DDME-XXWX*PHTI                               | DDME-XXWX*PXTI                               |

##### Tin-Plated Shell with Grounding Indents and Dual Float Bushings

| Shell Size | .125 Tail Length<br>.030 Contact<br>Diameter | .158 Tail Length<br>.030 Contact<br>Diameter | .185 Tail Length<br>.030 Contact<br>Diameter | .125 Tail Length<br>.040 Contact<br>Diameter | .158 Tail Length<br>.040 Contact<br>Diameter | .185 Tail Length<br>.040 Contact<br>Diameter |
|------------|--|--|--|--|--|--|
| E          | DEMY-XXWX*PETI                               | DEMY-XXWX*PMTI                               | DEMY-XXWX*PZTI                               | DEMY-XXWX*PBTI                               | DEMY-XXWX*PHTI                               | DEMY-XXWX*PXTI                               |
| A          | DAMY-XXWX*PETI                               | DAMY-XXWX*PMTI                               | DAMY-XXWX*PZTI                               | DAMY-XXWX*PBTI                               | DAMY-XXWX*PHTI                               | DAMY-XXWX*PXTI                               |
| B          | DBMY-XXWX*PETI                               | DBMY-XXWX*PMTI                               | DBMY-XXWX*PZTI                               | DBMY-XXWX*PBTI                               | DBMY-XXWX*PHTI                               | DBMY-XXWX*PXTI                               |
| C          | DCMY-XXWX*PETI                               | DCMY-XXWX*PMTI                               | DCMY-XXWX*PZTI                               | DCMY-XXWX*PBTI                               | DCMY-XXWX*PHTI                               | DCMY-XXWX*PXTI                               |
| D          | DDMY-XXWX*PETI                               | DDMY-XXWX*PMTI                               | DDMY-XXWX*PZTI                               | DDMY-XXWX*PBTI                               | DDMY-XXWX*PHTI                               | DDMY-XXWX*PXTI                               |

#### 50µin. Gold Plating

##### Cadmium-Plated Shell with Yellow Chromate Finish and Mounting Holes

| Shell Size | .125 Tail Length<br>.030 Contact<br>Diameter | .158 Tail Length<br>.030 Contact<br>Diameter | .185 Tail Length<br>.030 Contact<br>Diameter | .125 Tail Length<br>.040 Contact<br>Diameter | .158 Tail Length<br>.040 Contact<br>Diameter | .185 Tail Length<br>.040 Contact<br>Diameter |
|------------|--|--|--|--|--|--|
| E          | DEMM-XXWX*PE                                 | DEMM-XXWX*PM                                 | DEMM-XXWX*PZ                                 | DEMM-XXWX*PB                                 | DEMM-XXWX*PH                                 | DEMM-XXWX*PX                                 |
| A          | DAMM-XXWX*PE                                 | DAMM-XXWX*PM                                 | DAMM-XXWX*PZ                                 | DAMM-XXWX*PB                                 | DAMM-XXWX*PH                                 | DAMM-XXWX*PX                                 |
| B          | DBMM-XXWX*PE                                 | DBMM-XXWX*PM                                 | DBMM-XXWX*PZ                                 | DBMM-XXWX*PB                                 | DBMM-XXWX*PH                                 | DBMM-XXWX*PX                                 |
| C          | DCMM-XXWX*PE                                 | DCMM-XXWX*PM                                 | DCMM-XXWX*PZ                                 | DCMM-XXWX*PB                                 | DCMM-XXWX*PH                                 | DCMM-XXWX*PX                                 |
| D          | DDMM-XXWX*PE                                 | DDMM-XXWX*PM                                 | DDMM-XXWX*PZ                                 | DDMM-XXWX*PB                                 | DDMM-XXWX*PH                                 | DDMM-XXWX*PX                                 |

##### Cadmium-Plated Shell with Yellow Chromate Finish and 4-40 Clinch Nuts

| Shell Size | .125 Tail Length<br>.030 Contact<br>Diameter | .158 Tail Length<br>.030 Contact<br>Diameter | .185 Tail Length<br>.030 Contact<br>Diameter | .125 Tail Length<br>.040 Contact<br>Diameter | .158 Tail Length<br>.040 Contact<br>Diameter | .185 Tail Length<br>.040 Contact<br>Diameter |
|------------|--|--|--|--|--|--|
| E          | DEMME-XXWX*PE                                | DEMME-XXWX*PM                                | DEMME-XXWX*PZ                                | DEMME-XXWX*PB                                | DEMME-XXWX*PH                                | DEMME-XXWX*PX                                |
| A          | DAMME-XXWX*PE                                | DAMME-XXWX*PM                                | DAMME-XXWX*PZ                                | DAMME-XXWX*PB                                | DAMME-XXWX*PH                                | DAMME-XXWX*PX                                |
| B          | DBMME-XXWX*PE                                | DBMME-XXWX*PM                                | DBMME-XXWX*PZ                                | DBMME-XXWX*PB                                | DBMME-XXWX*PH                                | DBMME-XXWX*PX                                |
| C          | DCMME-XXWX*PE                                | DCMME-XXWX*PM                                | DCMME-XXWX*PZ                                | DCMME-XXWX*PB                                | DCMME-XXWX*PH                                | DCMME-XXWX*PX                                |
| D          | DDMME-XXWX*PE                                | DDMME-XXWX*PM                                | DDMME-XXWX*PZ                                | DDMME-XXWX*PB                                | DDMME-XXWX*PH                                | DDMME-XXWX*PX                                |

##### Cadmium-Plated Shell with Yellow Chromate Finish and Dual Float Bushings

| Shell Size | .125 Tail Length<br>.030 Contact<br>Diameter | .158 Tail Length<br>.030 Contact<br>Diameter | .185 Tail Length<br>.030 Contact<br>Diameter | .125 Tail Length<br>.040 Contact<br>Diameter | .158 Tail Length<br>.040 Contact<br>Diameter | .185 Tail Length<br>.040 Contact<br>Diameter |
|------------|--|--|--|--|--|--|
| E          | DEMMY-XXWX*PE                                | DEMMY-XXWX*PM                                | DEMMY-XXWX*PZ                                | DEMMY-XXWX*PB                                | DEMMY-XXWX*PH                                | DEMMY-XXWX*PX                                |
| A          | DAMMY-XXWX*PE                                | DAMMY-XXWX*PM                                | DAMMY-XXWX*PZ                                | DAMMY-XXWX*PB                                | DAMMY-XXWX*PH                                | DAMMY-XXWX*PX                                |
| B          | DBMMY-XXWX*PE                                | DBMMY-XXWX*PM                                | DBMMY-XXWX*PZ                                | DBMMY-XXWX*PB                                | DBMMY-XXWX*PH                                | DBMMY-XXWX*PX                                |
| C          | DCMMY-XXWX*PE                                | DCMMY-XXWX*PM                                | DCMMY-XXWX*PZ                                | DCMMY-XXWX*PB                                | DCMMY-XXWX*PH                                | DCMMY-XXWX*PX                                |
| D          | DDMMY-XXWX*PE                                | DDMMY-XXWX*PM                                | DDMMY-XXWX*PZ                                | DDMMY-XXWX*PB                                | DDMMY-XXWX*PH                                | DDMMY-XXWX*PX                                |

\*Note: XXWX means insert combo layout contact arrangement from page 4-56 in catalog number i.e., 13W3.

# D-subminiature Metal Shell - Combination Layout

## Vertical PCB Mount Dip Solder Tails

### Series 1 High Reliability



#### Ordering Information

#### Combo D-sub Vertical PCB Sockets

#### 30µin. Gold Plating

#### Zinc-Plated Shell with Yellow Chromate Finish and Mounting Holes

| Shell Size | .125 Tail Length<br>.030 Contact<br>Diameter | .158 Tail Length<br>.030 Contact<br>Diameter | .185 Tail Length<br>.030 Contact<br>Diameter | .125 Tail Length<br>.040 Contact<br>Diameter | .158 Tail Length<br>.040 Contact<br>Diameter | .185 Tail Length<br>.040 Contact<br>Diameter |
|------------|--|--|--|--|--|--|
| E          | DEM-XXWX*SE                                  | DEM-XXWX*SM                                  | DEM-XXWX*SZ                                  | DEM-XXWX*SB                                  | DEM-XXWX*SH                                  | DEM-XXWX*SX                                  |
| A          | DAM-XXWX*SE                                  | DAM-XXWX*SM                                  | DAM-XXWX*SZ                                  | DAM-XXWX*SB                                  | DAM-XXWX*SH                                  | DAM-XXWX*SX                                  |
| B          | DBM-XXWX*SE                                  | DBM-XXWX*SM                                  | DBM-XXWX*SZ                                  | DBM-XXWX*SB                                  | DBM-XXWX*SH                                  | DBM-XXWX*SX                                  |
| C          | DCM-XXWX*SE                                  | DCM-XXWX*SM                                  | DCM-XXWX*SZ                                  | DCM-XXWX*SB                                  | DCM-XXWX*SH                                  | DCM-XXWX*SX                                  |
| D          | DDM-XXWX*SE                                  | DDM-XXWX*SM                                  | DDM-XXWX*SZ                                  | DDM-XXWX*SB                                  | DDM-XXWX*SH                                  | DDM-XXWX*SX                                  |

#### Zinc-Plated Shell with Yellow Chromate Finish and 4-40 Clinch Nuts

| Shell Size | .125 Tail Length<br>.030 Contact<br>Diameter | .158 Tail Length<br>.030 Contact<br>Diameter | .185 Tail Length<br>.030 Contact<br>Diameter | .125 Tail Length<br>.040 Contact<br>Diameter | .158 Tail Length<br>.040 Contact<br>Diameter | .185 Tail Length<br>.040 Contact<br>Diameter |
|------------|--|--|--|--|--|--|
| E          | DEME-XXWX*SE                                 | DEME-XXWX*SM                                 | DEME-XXWX*SZ                                 | DEME-XXWX*SB                                 | DEME-XXWX*SH                                 | DEME-XXWX*SX                                 |
| A          | DAME-XXWX*SE                                 | DAME-XXWX*SM                                 | DAME-XXWX*SZ                                 | DAME-XXWX*SB                                 | DAME-XXWX*SH                                 | DAME-XXWX*SX                                 |
| B          | DBME-XXWX*SE                                 | DBME-XXWX*SM                                 | DBME-XXWX*SZ                                 | DBME-XXWX*SB                                 | DBME-XXWX*SH                                 | DBME-XXWX*SX                                 |
| C          | DCME-XXWX*SE                                 | DCME-XXWX*SM                                 | DCME-XXWX*SZ                                 | DCME-XXWX*SB                                 | DCME-XXWX*SH                                 | DCME-XXWX*SX                                 |
| D          | DDME-XXWX*SE                                 | DDME-XXWX*SM                                 | DDME-XXWX*SZ                                 | DDME-XXWX*SB                                 | DDME-XXWX*SH                                 | DDME-XXWX*SX                                 |

4

#### Zinc-Plated Shell with Yellow Chromate Finish and Dual Float Bushings

| Shell Size | .125 Tail Length<br>.030 Contact<br>Diameter | .158 Tail Length<br>.030 Contact<br>Diameter | .185 Tail Length<br>.030 Contact<br>Diameter | .125 Tail Length<br>.040 Contact<br>Diameter | .158 Tail Length<br>.040 Contact<br>Diameter | .185 Tail Length<br>.040 Contact<br>Diameter |
|------------|--|--|--|--|--|--|
| E          | DEMY-XXWX*SE                                 | DEMY-XXWX*SM                                 | DEMY-XXWX*SZ                                 | DEMY-XXWX*SB                                 | DEMY-XXWX*SH                                 | DEMY-XXWX*SX                                 |
| A          | DAMY-XXWX*SE                                 | DAMY-XXWX*SM                                 | DAMY-XXWX*SZ                                 | DAMY-XXWX*SB                                 | DAMY-XXWX*SH                                 | DAMY-XXWX*SX                                 |
| B          | DBMY-XXWX*SE                                 | DBMY-XXWX*SM                                 | DBMY-XXWX*SZ                                 | DBMY-XXWX*SB                                 | DBMY-XXWX*SH                                 | DBMY-XXWX*SX                                 |
| C          | DCMY-XXWX*SE                                 | DCMY-XXWX*SM                                 | DCMY-XXWX*SZ                                 | DCMY-XXWX*SB                                 | DCMY-XXWX*SH                                 | DCMY-XXWX*SX                                 |
| D          | DDMY-XXWX*SE                                 | DDMY-XXWX*SM                                 | DDMY-XXWX*SZ                                 | DDMY-XXWX*SB                                 | DDMY-XXWX*SH                                 | DDMY-XXWX*SX                                 |

#### Tin-Plated Shell with Mounting Holes

| Shell Size | .125 Tail Length<br>.030 Contact<br>Diameter | .158 Tail Length<br>.030 Contact<br>Diameter | .185 Tail Length<br>.030 Contact<br>Diameter | .125 Tail Length<br>.040 Contact<br>Diameter | .158 Tail Length<br>.040 Contact<br>Diameter | .185 Tail Length<br>.040 Contact<br>Diameter |
|------------|--|--|--|--|--|--|
| E          | DEM-XXWX*SET                                 | DEM-XXWX*SMT                                 | DEM-XXWX*SZT                                 | DEM-XXWX*SBT                                 | DEM-XXWX*SHT                                 | DEM-XXWX*SXT                                 |
| A          | DAM-XXWX*SET                                 | DAM-XXWX*SMT                                 | DAM-XXWX*SZT                                 | DAM-XXWX*SBT                                 | DAM-XXWX*SHT                                 | DAM-XXWX*SXT                                 |
| B          | DBM-XXWX*SET                                 | DBM-XXWX*SMT                                 | DBM-XXWX*SZT                                 | DBM-XXWX*SBT                                 | DBM-XXWX*SHT                                 | DBM-XXWX*SXT                                 |
| C          | DCM-XXWX*SET                                 | DCM-XXWX*SMT                                 | DCM-XXWX*SZT                                 | DCM-XXWX*SBT                                 | DCM-XXWX*SHT                                 | DCM-XXWX*SXT                                 |
| D          | DDM-XXWX*SET                                 | DDM-XXWX*SMT                                 | DDM-XXWX*SZT                                 | DDM-XXWX*SBT                                 | DDM-XXWX*SHT                                 | DDM-XXWX*SXT                                 |

\* Note: XXWX means insert combo layout contact arrangement from page 4-56 in catalog number i.e., 13W3.

# D-subminiature Metal Shell - Combination Layout

## Vertical PCB Mount Dip Solder Tails

### Series 1 - High Reliability



#### Ordering Information

#### Combo D-sub Vertical PCB Sockets (Cont'd)

#### 30µin. Gold Plating (Cont'd)

##### Tin-Plated Shell with 4-40 Clinch Nuts

| Shell Size | .125 Tail Length<br>.030 Contact<br>Diameter | .158 Tail Length<br>.030 Contact<br>Diameter | .185 Tail Length<br>.030 Contact<br>Diameter | .125 Tail Length<br>.040 Contact<br>Diameter | .158 Tail Length<br>.040 Contact<br>Diameter | .185 Tail Length<br>.040 Contact<br>Diameter |
|------------|--|--|--|--|--|--|
| E          | DEME-XXWX*SET                                | DEME-XXWX*SMT                                | DEME-XXWX*SZT                                | DEME-XXWX*SBT                                | DEME-XXWX*SHT                                | DEME-XXWX*SXT                                |
| A          | DAME-XXWX*SET                                | DAME-XXWX*SMT                                | DAME-XXWX*SZT                                | DAME-XXWX*SBT                                | DAME-XXWX*SHT                                | DAME-XXWX*SXT                                |
| B          | DBME-XXWX*SET                                | DBME-XXWX*SMT                                | DBME-XXWX*SZT                                | DBME-XXWX*SBT                                | DBME-XXWX*SHT                                | DBME-XXWX*SXT                                |
| C          | DCME-XXWX*SET                                | DCME-XXWX*SMT                                | DCME-XXWX*SZT                                | DCME-XXWX*SBT                                | DCME-XXWX*SHT                                | DCME-XXWX*SXT                                |
| D          | DDME-XXWX*SET                                | DDME-XXWX*SMT                                | DDME-XXWX*SZT                                | DDME-XXWX*SBT                                | DDME-XXWX*SHT                                | DDME-XXWX*SXT                                |

##### Tin-Plated Shell and Dual Float Bushings

| Shell Size | .125 Tail Length<br>.030 Contact<br>Diameter | .158 Tail Length<br>.030 Contact<br>Diameter | .185 Tail Length<br>.030 Contact<br>Diameter | .125 Tail Length<br>.040 Contact<br>Diameter | .158 Tail Length<br>.040 Contact<br>Diameter | .185 Tail Length<br>.040 Contact<br>Diameter |
|------------|--|--|--|--|--|--|
| E          | DEMY-XXWX*SET                                | DEMY-XXWX*SMT                                | DEMY-XXWX*SZT                                | DEMY-XXWX*SBT                                | DEMY-XXWX*SHT                                | DEMY-XXWX*SXT                                |
| A          | DAMY-XXWX*SET                                | DAMY-XXWX*SMT                                | DAMY-XXWX*SZT                                | DAMY-XXWX*SBT                                | DAMY-XXWX*SHT                                | DAMY-XXWX*SXT                                |
| B          | DBMY-XXWX*SET                                | DBMY-XXWX*SMT                                | DBMY-XXWX*SZT                                | DBMY-XXWX*SBT                                | DBMY-XXWX*SHT                                | DBMY-XXWX*SXT                                |
| C          | DCMY-XXWX*SET                                | DCMY-XXWX*SMT                                | DCMY-XXWX*SZT                                | DCMY-XXWX*SBT                                | DCMY-XXWX*SHT                                | DCMY-XXWX*SXT                                |
| D          | DDMY-XXWX*SET                                | DDMY-XXWX*SMT                                | DDMY-XXWX*SZT                                | DDMY-XXWX*SBT                                | DDMY-XXWX*SHT                                | DDMY-XXWX*SXT                                |

#### 50µin. Gold Plating

##### Cadmium-Plated Shell with Yellow Chromate Finish and Mounting Holes

| Shell Size | .125 Tail Length<br>.030 Contact<br>Diameter | .158 Tail Length<br>.030 Contact<br>Diameter | .185 Tail Length<br>.030 Contact<br>Diameter | .125 Tail Length<br>.040 Contact<br>Diameter | .158 Tail Length<br>.040 Contact<br>Diameter | .185 Tail Length<br>.040 Contact<br>Diameter |
|------------|--|--|--|--|--|--|
| E          | DEMM-XXWX*SE                                 | DEMM-XXWX*SM                                 | DEMM-XXWX*SZ                                 | DEMM-XXWX*SB                                 | DEMM-XXWX*SH                                 | DEMM-XXWX*SX                                 |
| A          | DAMM-XXWX*SE                                 | DAMM-XXWX*SM                                 | DAMM-XXWX*SZ                                 | DAMM-XXWX*SB                                 | DAMM-XXWX*SH                                 | DAMM-XXWX*SX                                 |
| B          | DBMM-XXWX*SE                                 | DBMM-XXWX*SM                                 | DBMM-XXWX*SZ                                 | DBMM-XXWX*PB                                 | DBMM-XXWX*SH                                 | DBMM-XXWX*SX                                 |
| C          | DCMM-XXWX*SE                                 | DCMM-XXWX*SM                                 | DCMM-XXWX*SZ                                 | DCMM-XXWX*SB                                 | DCMM-XXWX*SH                                 | DCMM-XXWX*SX                                 |
| D          | DDMM-XXWX*SE                                 | DDMM-XXWX*SM                                 | DDMM-XXWX*SZ                                 | DDMM-XXWX*SB                                 | DDMM-XXWX*SH                                 | DDMM-XXWX*SX                                 |

##### Cadmium-Plated Shell with Yellow Chromate Finish and 4-40 Clinch Nuts

| Shell Size | .125 Tail Length<br>.030 Contact<br>Diameter | .158 Tail Length<br>.030 Contact<br>Diameter | .185 Tail Length<br>.030 Contact<br>Diameter | .125 Tail Length<br>.040 Contact<br>Diameter | .158 Tail Length<br>.040 Contact<br>Diameter | .185 Tail Length<br>.040 Contact<br>Diameter |
|------------|--|--|--|--|--|--|
| E          | DEMME-XXWX*SE                                | DEMME-XXWX*SM                                | DEMME-XXWX*SZ                                | DEMME-XXWX*SB                                | DEMME-XXWX*SH                                | DEMME-XXWX*SX                                |
| A          | DAMME-XXWX*SE                                | DAMME-XXWX*SM                                | DAMME-XXWX*SZ                                | DAMME-XXWX*SB                                | DAMME-XXWX*SH                                | DAMME-XXWX*SX                                |
| B          | DBMME-XXWX*SE                                | DBMME-XXWX*SM                                | DBMME-XXWX*SZ                                | DBMME-XXWX*SB                                | DBMME-XXWX*SH                                | DBMME-XXWX*SX                                |
| C          | DCMME-XXWX*SE                                | DCMME-XXWX*SM                                | DCMME-XXWX*SZ                                | DCMME-XXWX*SB                                | DCMME-XXWX*SH                                | DCMME-XXWX*SX                                |
| D          | DDMME-XXWX*SE                                | DDMME-XXWX*SM                                | DDMME-XXWX*SZ                                | DDMME-XXWX*SB                                | DDMME-XXWX*SH                                | DDMME-XXWX*SX                                |

##### Cadmium-Plated Shell with Yellow Chromate Finish and Dual Float Bushings

| Shell Size | .125 Tail Length<br>.030 Contact<br>Diameter | .158 Tail Length<br>.030 Contact<br>Diameter | .185 Tail Length<br>.030 Contact<br>Diameter | .125 Tail Length<br>.040 Contact<br>Diameter | .158 Tail Length<br>.040 Contact<br>Diameter | .185 Tail Length<br>.040 Contact<br>Diameter |
|------------|--|--|--|--|--|--|
| E          | DEMMY-XXWX*SE                                | DEMMY-XXWX*SM                                | DEMMY-XXWX*SZ                                | DEMMY-XXWX*SB                                | DEMMY-XXWX*SH                                | DEMMY-XXWX*SX                                |
| A          | DAMMY-XXWX*SE                                | DAMMY-XXWX*SM                                | DAMMY-XXWX*SZ                                | DAMMY-XXWX*SB                                | DAMMY-XXWX*SH                                | DAMMY-XXWX*SX                                |
| B          | DBMMY-XXWX*SE                                | DBMMY-XXWX*SM                                | DBMMY-XXWX*SZ                                | DBMMY-XXWX*SB                                | DBMMY-XXWX*SH                                | DBMMY-XXWX*SX                                |
| C          | DCMMY-XXWX*SE                                | DCMMY-XXWX*SM                                | DCMMY-XXWX*SZ                                | DCMMY-XXWX*SB                                | DCMMY-XXWX*SH                                | DCMMY-XXWX*SX                                |
| D          | DDMMY-XXWX*SE                                | DDMMY-XXWX*SM                                | DDMMY-XXWX*SZ                                | DDMMY-XXWX*SB                                | DDMMY-XXWX*SH                                | DDMMY-XXWX*SX                                |

\*Note: XXWX means insert combo layout contact arrangement from page 4-56 in catalog number i.e., 13W3.

## D-subminiature Contacts Coaxial - High Power - High Voltage



FEATURES

- Available in Coaxial (50Ω and 75Ω), High-Voltage, and High-Power styles.
- Cable termination and PCB mount contacts are available in right-angle and straight plugs and receptacles.
- Precision screw machine construction results in uniform contact impedance and excellent contact retention.
- Available with 30μin. or 50μin. gold contact plating.
- Cable braid can be soldered or crimped.
- See pages 4-55 thru 4-61 for Cinch combination layout D-subminiature connectors.

### Termination Tooling

- No tools are required for coaxial contact insertion. Contacts snap into connector. Coaxial and high-voltage contact extraction tool #CET-C6B for removing contacts after termination. See page 4-103.
- Tool to crimp sleeve over cable braid: Use 3-cavity die #CCD-26 with crimp frame #FCT-552. See page 4-103.

### NOTE: In order to determine which contact to use with a cable wire not specifically listed:

- Check the style of contact required: straight or right-angle, solder braid or crimp braid, etc.
- Refer to the cable wire manufacturer's specifications to determine:
  - The O.D. of the insulator.
  - The O.D. of the jacket.
- Compare the above with the corresponding dimensions C and E in the straight contacts and dimensions B and C in the right-angle contacts.



# D-subminiature Contacts

## Coaxial - 50Ω

### Right-Angle and Straight



#### Materials

- Receptacle: Body - Beryllium copper, Insulator - Teflon, Contacts - Brass.
- Plug: Body - Brass, Insulator - Teflon, Contacts - Beryllium copper.
- Plating: 30μin. gold over nickel, 50μin. gold over copper.

#### Electrical Characteristics

##### Dielectric Withstanding Voltage:

- Cable Contacts: minimum AC 1000V RMS @ sea level.
- PCB Contacts: minimum AC 800V RMS @ sea level.

Frequency Range: 0-900 MHz.

#### Right-Angle

##### Plug



##### Receptacle



#### Straight

##### Plug



##### Receptacle



#### Ordering Information

##### Right-Angle PCB Coaxial Contacts - 50Ω

|         | 30μin. Gold | 50μin. Gold |
|---------|-------------|-------------|
| Plug    | DM53761-30  | DM53761-50  |
| Recept. | DM53763-30  | DM53763-50  |

##### Straight PCB Coaxial Contacts - 50Ω

|         | 30μin. Gold | 50μin. Gold |
|---------|-------------|-------------|
| Plug    | DM53760-30  | DM53760-50  |
| Recept. | DM53762-30  | DM53762-50  |

# D-subminiature Contacts

## Coaxial - 50Ω

### Straight



- Material and electrical specifications: See page 4-63.



Plug

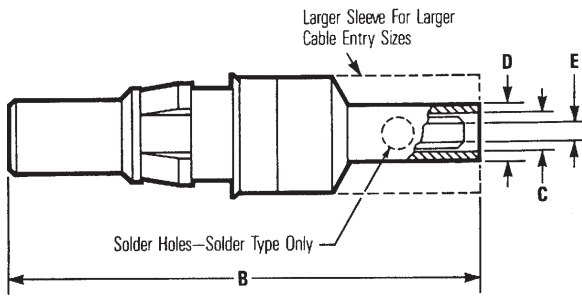

Receptacle

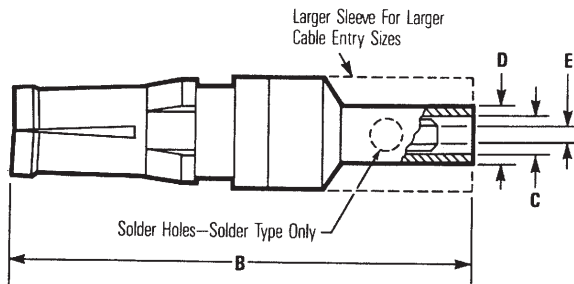

4

## Ordering Information

### Straight Solder Braid Coaxial Contacts

|         | 30µin. Gold  |              | 50µin. Gold |       | A Max. |       | B Ref. |      | C    |      | D    |      | E ±.005" |        | RG Cable |     |
|---------|--------------|--------------|-------------|-------|--------|-------|--------|------|------|------|------|------|----------|--------|----------|-----|
|         | Part No.     | Part No.     | in          | mm    | in     | mm    | in     | mm   | in   | mm   | in   | mm   | in       | mm     | Old      | New |
| Plug    | DM53740-5008 | DM53740-5105 | .739        | 18.77 | 0.929  | 23.60 | .093   | 2.36 | .124 | 3.15 | .040 | 1.02 | 196/U    | 178B/U |          |     |
| Plug    | DM53740-5001 | DM53740-5099 | .739        | 18.77 | 0.929  | 23.60 | .125   | 3.18 | .152 | 3.86 | .067 | 1.70 | 187/U    | 179B/U |          |     |
| Plug    | DM53740-5002 | DM53740-5104 | .847        | 21.51 | 1.037  | 26.34 | .202   | 5.13 | .235 | 5.97 | .110 | 2.79 | 195/U    | 180B/U |          |     |
| Plug    | DM53740-5005 | DM53740-5101 | .847        | 21.51 | 1.037  | 26.34 | .202   | 5.13 | .235 | 5.97 | .125 | 3.18 | 58/U     | 58B/U  |          |     |
| Recept. | DM53742-5006 | DM53742-5092 | .739        | 18.77 | 0.929  | 23.60 | .093   | 2.36 | .124 | 3.15 | .040 | 1.02 | 196/U    | 178B/U |          |     |
| Recept. | DM53742-5001 | DM53742-5089 | .739        | 18.77 | 0.929  | 23.60 | .125   | 3.18 | .152 | 3.86 | .067 | 1.70 | 187/U    | 179B/U |          |     |
| Recept. | DM53742-5002 | DM53742-5091 | .847        | 21.51 | 1.037  | 26.34 | .202   | 5.13 | .235 | 5.97 | .110 | 2.79 | 195/U    | 180B/U |          |     |
| Recept. | DM53742-5004 | DM53742-5086 | .847        | 21.51 | 1.037  | 26.34 | .202   | 5.13 | .235 | 5.97 | .125 | 3.18 | 58/U     | 58B/U  |          |     |
| Plug    | DM53740-5000 | DM53740-5100 | .670        | 17.02 | 0.860  | 21.84 | .093   | 2.36 | .124 | 3.15 | .040 | 1.02 | 196/U    | 178B/U |          |     |
| Recept. | DM53742-5000 | DM53742-5085 | .670        | 17.02 | 0.860  | 21.84 | .093   | 2.36 | .124 | 3.15 | .040 | 1.02 | 196/U    | 178B/U |          |     |

### Straight Crimp Braid Coaxial Contacts

|         | 30µin. Gold |            | 50µin. Gold |       | A Max. |       | B Ref. |      | C    |      | D    |      | E ±.005"        |                   | RG Cable |     |
|---------|-------------|------------|-------------|-------|--------|-------|--------|------|------|------|------|------|-----------------|-------------------|----------|-----|
|         | Part No.    | Part No.   | in          | mm    | in     | mm    | in     | mm   | in   | mm   | in   | mm   | in              | mm                | Old      | New |
| Plug    | DM53740     | DM53740-17 | .739        | 18.77 | .929   | 23.60 | .093   | 2.36 | .124 | 3.15 | .040 | 1.02 | 196/U           | 178B/U            |          |     |
| Plug    | DM53740-1   | DM53740-15 | .739        | 18.77 | .929   | 23.60 | .125   | 3.18 | .152 | 3.86 | .067 | 1.70 | 187/U           | 179B/U            |          |     |
| Plug    | DM53740-3   | DM53740-16 | .847        | 21.51 | 1.037  | 26.34 | .202   | 5.13 | .235 | 5.97 | .110 | 2.79 | 195/U           | 180B/U            |          |     |
| Plug    | DM53740-5   | DM53740-18 | .847        | 21.51 | 1.037  | 26.34 | .202   | 5.13 | .235 | 5.97 | .125 | 3.18 | 58/U            | 58B/U             |          |     |
| Recept. | DM53742     | DM53742-18 | .739        | 18.77 | .929   | 23.60 | .093   | 2.36 | .124 | 3.15 | .040 | 1.02 | 196/U           | 178B/U            |          |     |
| Recept. | DM53742-1   | DM53742-16 | .739        | 18.77 | .929   | 23.60 | .125   | 3.18 | .152 | 3.86 | .067 | 1.70 | 187/U,<br>188/U | 179B/U,<br>316/BU |          |     |
| Recept. | DM53742-3   | DM53742-17 | .847        | 21.51 | 1.037  | 26.34 | .202   | 5.13 | .235 | 5.97 | .110 | 2.79 | 195/U           | 180B/U            |          |     |
| Recept. | DM53742-5   | DM53742-19 | .847        | 21.51 | 1.037  | 26.34 | .202   | 5.13 | .235 | 5.97 | .125 | 3.18 | 58/U            | 58B/U             |          |     |

# D-subminiature Contacts

## Coaxial - 50Ω

### Right Angle

- Material and electrical specifications: See page 4-63.

#### Plug



#### Receptacle



### Right-Angle Solder Braid Coaxial Contacts - 50Ω

| 30μin. Gold        | 50μin. Gold  | A    |       | B    |       | C    |       | D    |      | E    |      | F    |      | RG Cable |                         |
|--------------------|--------------|------|-------|------|-------|------|-------|------|------|------|------|------|------|----------|-------------------------|
|                    |              | in   | mm    | in   | mm    | in   | mm    | in   | mm   | in   | mm   | in   | mm   | Old      | New                     |
| <b>Plugs</b>       |              |      |       |      |       |      |       |      |      |      |      |      |      |          |                         |
| DM53741-5000       | DM53741-5059 | .530 | 13.46 | .734 | 18.64 | .492 | 12.50 | .040 | 1.02 | .093 | 2.36 | .125 | 3.18 | RG 196/U | RG 178B/U               |
| DM53741-5001       | DM53741-5062 | .530 | 13.46 | .734 | 18.64 | .492 | 12.50 | .067 | 1.70 | .125 | 3.18 | .152 | 3.86 | RG 187/U | RG 179B/U,<br>RG 316B/U |
| DM53741-5003       | DM53741-5063 | .530 | 13.46 | .734 | 18.64 | .601 | 15.27 | .110 | 2.79 | .202 | 5.13 | .235 | 5.97 | RG 195/U | RG 180B/U               |
| DM53741-5004       | DM53741-5060 | .530 | 13.46 | .734 | 18.64 | .601 | 15.27 | .125 | 3.18 | .202 | 5.13 | .235 | 5.97 | RG 196/U | RG 58B/U                |
| <b>Receptacles</b> |              |      |       |      |       |      |       |      |      |      |      |      |      |          |                         |
| DM53743-5000       | DM53743-5073 | .530 | 13.46 | .734 | 18.64 | .492 | 12.50 | .040 | 1.02 | .093 | 2.36 | .125 | 3.18 | RG 196/U | RG 178B/U               |
| DM53743-5001       | DM53743-5076 | .530 | 13.46 | .734 | 18.64 | .492 | 12.50 | .067 | 1.70 | .125 | 3.18 | .152 | 3.86 | RG 187/U | RG 179B/U,<br>RG 316B/U |
| DM53743-5003       | DM53743-5077 | .530 | 13.46 | .734 | 18.64 | .601 | 15.27 | .110 | 2.79 | .202 | 5.13 | .235 | 5.97 | RG 195/U | RG 180B/U               |
| DM53743-5004       | DM53743-5074 | .530 | 13.46 | .734 | 18.64 | .601 | 15.27 | .125 | 3.18 | .202 | 5.13 | .235 | 5.97 | RG 58/U  | RG 58B/U                |

### Right-Angle Crimp Braid Coaxial Contacts - 50Ω

| 30μin. Gold        | 50μin. Gold | A    |       | B    |       | C    |       | D    |      | E    |      | F    |      | RG Cable |                         |
|--------------------|-------------|------|-------|------|-------|------|-------|------|------|------|------|------|------|----------|-------------------------|
|                    |             | in   | mm    | in   | mm    | in   | mm    | in   | mm   | in   | mm   | in   | mm   | Old      | New                     |
| <b>Plugs</b>       |             |      |       |      |       |      |       |      |      |      |      |      |      |          |                         |
| DM53741-0          | DM53741-12  | .530 | 13.46 | .734 | 18.64 | .492 | 12.50 | .040 | 1.02 | .093 | 2.36 | .125 | 3.18 | RG 196/U | RG 178B/U               |
| DM53741-1          | DM53741-11  | .530 | 13.46 | .734 | 18.64 | .492 | 12.50 | .067 | 1.70 | .125 | 3.18 | .152 | 3.86 | RG 187/U | RG 179B/U,<br>RG 316B/U |
| DM53741-3          | DM53741-10  | .530 | 13.46 | .734 | 18.64 | .601 | 15.27 | .110 | 2.79 | .202 | 5.13 | .235 | 5.97 | RG 195/U | RG 180B/U               |
| DM53741-4          | DM53741-13  | .530 | 13.46 | .734 | 18.64 | .601 | 15.27 | .125 | 3.18 | .202 | 5.13 | .235 | 5.97 | RG 58/U  | RG 58B/U                |
| <b>Receptacles</b> |             |      |       |      |       |      |       |      |      |      |      |      |      |          |                         |
| DM53743-2          | DM53743-18  | .530 | 13.46 | .734 | 18.64 | .492 | 12.50 | .040 | 1.02 | .093 | 2.36 | .125 | 3.18 | RG 196/U | RG 178B/U               |
| DM53743-3          | DM53743-16  | .530 | 13.46 | .734 | 18.64 | .492 | 12.50 | .067 | 1.70 | .125 | 3.18 | .152 | 3.86 | RG 187/U | RG 179B/U,<br>RG 316B/U |
| DM53743-5          | DM53743-17  | .530 | 13.46 | .734 | 18.64 | .601 | 15.27 | .110 | 2.79 | .202 | 5.13 | .235 | 5.97 | RG 195/U | RG 180B/U               |
| DM53743-6          | DM53743-19  | .530 | 13.46 | .734 | 18.64 | .601 | 15.27 | .125 | 3.18 | .202 | 5.13 | .235 | 5.97 | RG 58/U  | RG 58B/U                |

# D-subminiature Contacts

## Coaxial - 75Ω

### Straight



#### Materials

- Receptacle: Body - Brass or beryllium copper, Insulator - Teflon, Contacts - Brass.
- Plug: Body - Brass, Insulator - Teflon, Contacts - Beryllium copper.
- Plating: 30μin. gold over nickel, 50μin. gold over copper

#### Electrical Characteristics

**Nominal Impedance:** 75Ω.

**Dielectric Withstanding Voltage:** Minimum 1000V RMS @ sea level.

**VWSR:** 1.05 max. for 0-1 GHz and 1.25 max for 1-2 GHz

Plug



Receptacle



4

#### Ordering Information

##### 75Ω Crimp/Solder Termination Straight Coaxial Contacts

|         | 30μin. Gold | 50μin. Gold | A     |       | B    |      | Material         | Cable       |
|---------|-------------|-------------|-------|-------|------|------|------------------|-------------|
|         |             |             | in    | mm    | in   | mm   |                  |             |
| Plug    | DM53750-12  | DM53750-52  | 1.037 | 26.34 | .108 | 2.74 | Brass            | Belden 8218 |
| Plug    | DM53750-11  | DM53750-51  | 0.929 | 23.60 | .067 | 1.70 | Brass            | RG 179 B/U  |
| Recept. | DM53752-8   | DM53752-58  | 1.037 | 26.34 | .108 | 2.74 | Brass            | Belden 8218 |
| Recept. | DM53752-7   | DM53752-57  | 0.929 | 23.60 | .067 | 1.70 | Brass            | RG 179 B/U  |
| Recept. | DM53752-6   | DM53752-56  | 1.037 | 26.34 | .108 | 2.74 | Beryllium Copper | Belden 8218 |
| Recept. | DM53752-5   | DM53752-55  | 0.929 | 23.60 | .067 | 1.70 | Beryllium Copper | RG 179 B/U  |

##### 75Ω Crimp/Crimp Termination Straight Coaxial Contacts

|         | 30μin. Gold | 50μin. Gold | A     |       | B    |      | Material         | Cable       |
|---------|-------------|-------------|-------|-------|------|------|------------------|-------------|
|         |             |             | in    | mm    | in   | mm   |                  |             |
| Plug    | DM53750-010 | DM53750-510 | 1.050 | 26.67 | .108 | 2.74 | Brass            | Belden 8218 |
| Plug    | DM53750-009 | DM53750-509 | 1.050 | 26.67 | .067 | 1.70 | Brass            | RG 179 B/U  |
| Recept. | DM53752-004 | DM53752-504 | 1.090 | 27.69 | .108 | 2.74 | Brass            | Belden 8218 |
| Recept. | DM53752-003 | DM53752-503 | 1.090 | 27.69 | .067 | 1.70 | Brass            | RG 179 B/U  |
| Recept. | DM53752-002 | DM53752-502 | 1.090 | 27.69 | .108 | 2.74 | Beryllium Copper | Belden 8218 |
| Recept. | DM53752-001 | DM53752-501 | 1.090 | 27.69 | .067 | 1.70 | Beryllium Copper | RG 179 B/U  |



# D-subminiature Contacts High Voltage Right-Angle and Straight



## Materials

- Contact: Body - Nylon per MIL-P-20693
- Plating: 30µin. gold over nickel, 50µin. gold over copper

## Electrical Characteristics

**Dielectric Withstanding Voltage:** Minimum AC 2800VAC RMS to shell @ sea level

**High-Voltage Contacts - For #20 AWG wire**

### Straight

#### Plug



#### Receptacle



### Right-Angle

#### Plug



#### Receptacle



## Ordering Information

### Straight High-Voltage Contacts - #20 AWG Wire

|         | 30µin. Gold | 50µin. Gold | A    |       | B    |       | Wire Size |
|---------|-------------|-------------|------|-------|------|-------|-----------|
|         |             |             | in   | mm    | in   | mm    |           |
| Plug    | DM51157-0   | DM51157-8   | .539 | 13.69 | .734 | 18.64 | #20       |
| Recept. | DM51155-0   | DM51155-7   | .539 | 13.69 | .734 | 18.64 | #20       |

### Right-Angle High-Voltage Contacts - #20 AWG Wire

|         | 30µin. Gold  | 50µin. Gold  | A    |       | B    |       | Wire Size |
|---------|--------------|--------------|------|-------|------|-------|-----------|
|         |              |              | in   | mm    | in   | mm    |           |
| Plug    | DM51157-5000 | DM51157-5005 | .491 | 12.47 | .697 | 17.70 | #20       |
| Recept. | DM51155-5000 | DM51155-5004 | .491 | 12.47 | .697 | 17.70 | #20       |



# D-subminiature Contacts

## High-Power

### Straight



- High-Power Contacts will accommodate up to 40 Amps current rating.

#### Materials

- Contact Plating:
  - 30µin. gold over nickel
  - 50µin. gold over copper
- Receptacle: Beryllium copper
- Plug: Brass

#### Plug



#### Receptacle



#### Ordering Information

#### Straight High-Power Contacts

|         | 30µin. Gold | 50µin. Gold | A    |       | B    |       | C    |      | Current Rating (Amps) | Wire Size (AWG) |
|---------|-------------|-------------|------|-------|------|-------|------|------|-----------------------|-----------------|
|         |             |             | in   | mm    | in   | mm    | in   | mm   |                       |                 |
| Plug    | DM53745-1   | DM53745-28  | .666 | 16.92 | .866 | 22.00 | .188 | 4.78 | 40                    | #8              |
| Plug    | DM53745-7   | DM53745-27  | .666 | 16.92 | .866 | 22.00 | .112 | 2.84 | 20                    | #12             |
| Plug    | DM53745-8   | DM53745-25  | .666 | 16.92 | .866 | 22.00 | .069 | 1.75 | 10                    | #16             |
| Recept. | DM53744-1   | DM53744-21  | .666 | 16.92 | .866 | 22.00 | .188 | 4.78 | 40                    | #8              |
| Recept. | DM53744-6   | DM53744-25  | .666 | 16.92 | .866 | 22.00 | .112 | 2.84 | 20                    | #12             |
| Recept. | DM53744-7   | DM53744-24  | .666 | 16.92 | .866 | 22.00 | .069 | 1.75 | 10                    | #16             |

# D-subminiature Metal Shell Crimp and Poke Series 3 - High Reliability



## FEATURES

- **High-reliability in a commercial grade connector.**
- **Monoblock diallyl phthalate insulator for improved electrical performance.**
- **Offered in 9, 15, 25, 37, and 50 position plugs and sockets.**
- **Offered with .120 mounting holes, 4-40 clinch nuts, or dual float bushings.**
- **Commercial version of M24308 Military connectors with tin-plated or zinc-plated shell and 30µin. gold contact plating.**
- **Screw Machine Crimp and Poke contacts available as follows:**
  - **Note that all contacts are packed loose.**
  - **Plating options: 30µin. gold.**
  - **Can be included with the connector or purchased separately (FO part numbers).**
- **See pages 4-5 thru 4-10 for standard dimensions, contact arrangements, and panel mounting specifications.**

## MATERIALS

**Insulator Material:** Glass fiber-filled diallyl phthalate (green), UL 94V-0

**Connector Shell:** Steel with zinc plating and yellow chromate finish

**Contact Material:** Plug - Brass (machined), Socket - Phosphor bronze (machined)

**Contact Plating:** 30µin. gold over nickel

**4-40 Clinch Nut:** Steel with cadmium plating and yellow chromate finish

**Dual Float Bushing:** Stainless steel, passivated



## ENVIRONMENTAL

**Operating Temperature:** -65°C to + 125°C

**Shock:** 50G peak per MIL-STD-202, Method 213, Condition G

**Vibration:** 12 cycles in three perpendicular directions @ 10-2000Hz, per MIL-STD-202, Method 204, Condition D

**Moisture Resistance:** 90-95% relative humidity @ 40°C for 96 hours per MIL-STD-202, Method 103



## ELECTRICAL

**Withstanding Voltage:** Minimum 1250V RMS @ sea level

**Current Rating:** 5 Amps

**Contact Resistance:** 2.7 milliohms maximum

**Insulation Resistance:** 5000 megohms maximum (initial); 1000 megohms (minimum) after environmental testing



## MECHANICAL

**Individual Contact Insertion and Separation Force (minimum/maximum):** 0.7 oz./12 oz.

**Durability:** 500 mating cycles

# D-subminiature Metal Shell Crimp and Poke Series 3 - High Reliability



## Termination Tooling

- Contact Insertion/Extraction Tool: #CIET-20-HD (Military #M81969/39-01). See page 4-103.
- Crimp Contact Hand Tool: Military #M22520/2-01. See page 4-103. Contact Positioner (below) required.
- Positioner for machine contacts for Hand Tool #M22520/2-01 (locates contact in the correct position): #M22520/2-08. See page 4-103.

## Ordering Information

### Crimp and Poke - Plugs

#### Zinc-Plated Shell with Yellow Chromate Finish

| Positions | Mounting Holes       |                  | 4-40 Clinch Nuts     |                  | Dual Float Bushings  |                  |
|-----------|----------------------|------------------|----------------------|------------------|----------------------|------------------|
|           | 30µin. Gold Contacts | Without Contacts | 30µin. Gold Contacts | Without Contacts | 30µin. Gold Contacts | Without Contacts |
| 9         | DEMA-9P              | DEMA-9P-FO       | DEMAE-9P             | DEMAE-9P-FO      | DEMAY-9P             | DEMAY-9P-FO      |
| 15        | DAMA-15P             | DAMA-15P-FO      | DAMAE-15P            | DAMAE-15P-FO     | DAMAY-15P            | DAMAY-15P-FO     |
| 25        | DBMA-25P             | DBMA-25P-FO      | DBMAE-25P            | DBMAE-25P-FO     | DBMAY-25P            | DBMAY-25P-FO     |
| 37        | DCMA-37P             | DCMA-37P-FO      | DCMAE-37P            | DCMAE-37P-FO     | DCMAY-37P            | DCMAY-37P-FO     |
| 50        | DDMA-50P             | DDMA-50P-FO      | DDMAE-50P            | DDMAE-50P-FO     | DDMAY-50P            | DDMAY-50P-FO     |

#### Tin-Plated Shells with Grounding Indents

| Positions | Mounting Holes       |                  | 4-40 Clinch Nuts     |                  | Dual Float Bushings  |                  |
|-----------|----------------------|------------------|----------------------|------------------|----------------------|------------------|
|           | 30µin. Gold Contacts | Without Contacts | 30µin. Gold Contacts | Without Contacts | 30µin. Gold Contacts | Without Contacts |
| 9         | DEMA-9PTI            | DEMA-9PTI-FO     | DEMAE-9PTI           | DEMAE-9PTI-FO    | DEMAY-9PTI           | DEMAY-9PTI-FO    |
| 15        | DAMA-15PTI           | DAMA-15PTI-FO    | DAMAE-15PTI          | DAMAE-15PTI-FO   | DAMAY-15PTI          | DAMAY-15PTI-FO   |
| 25        | DBMA-25PTI           | DBMA-25PTI-FO    | DBMAE-25PTI          | DBMAE-25PTI-FO   | DBMAY-25PTI          | DBMAY-25PTI-FO   |
| 37        | DCMA-37PTI           | DCMA-37PTI-FO    | DCMAE-37PTI          | DCMAE-37PTI-FO   | DCMAY-37PTI          | DCMAY-37PTI-FO   |
| 50        | DDMA-50PTI           | DDMA-50PTI-FO    | DDMAE-50PTI          | DDMAE-50PTI-FO   | DDMAY-50PTI          | DDMAY-50PTI-FO   |

# D-subminiature Metal Shell Crimp and Poke Series 3 - High Reliability



## Ordering Information

### Crimp and Poke - Sockets

#### Zinc-Plated Shell with Yellow Chromate Finish

| Positions | Mounting Holes       |                  | 4-40 Clinch Nuts     |                  | Dual Float Bushings  |                  |
|-----------|----------------------|------------------|----------------------|------------------|----------------------|------------------|
|           | 30µin. Gold Contacts | Without Contacts | 30µin. Gold Contacts | Without Contacts | 30µin. Gold Contacts | Without Contacts |
| 9         | DEMA-9S              | DEMA-9S-FO       | DEMAE-9S             | DEMAE-9S-FO      | DEMAY-9S             | DEMAY-9S-FO      |
| 15        | DAMA-15S             | DAMA-15S-FO      | DAMAE-15S            | DAMAE-15S-FO     | DAMAY-15S            | DAMAY-15S-FO     |
| 25        | DBMA-25S             | DBMA-25S-FO      | DBMAE-25S            | DBMAE-25S-FO     | DBMAY-25S            | DBMAY-25S-FO     |
| 37        | DCMA-37S             | DCMA-37S-FO      | DCMAE-37S            | DCMAE-37S-FO     | DCMAY-37S            | DCMAY-37S-FO     |
| 50        | DDMA-50S             | DDMA-50S-FO      | DDMAE-50S            | DDMAE-50S-FO     | DDMAY-50S            | DDMAY-50S-FO     |

#### Tin-Plated Shell

| Positions | Mounting Holes       |                  | 4-40 Clinch Nuts     |                  | Dual Float Bushings  |                  |
|-----------|----------------------|------------------|----------------------|------------------|----------------------|------------------|
|           | 30µin. Gold Contacts | Without Contacts | 30µin. Gold Contacts | Without Contacts | 30µin. Gold Contacts | Without Contacts |
| 9         | DEMA-9ST             | DEMA-9ST-FO      | DEMAE-9ST            | DEMAE-9ST-FO     | DEMAY-9ST            | DEMAY-9ST-FO     |
| 15        | DAMA-15ST            | DAMA-15ST-FO     | DAMAE-15ST           | DAMAE-15ST-FO    | DAMAY-15ST           | DAMAY-15ST-FO    |
| 25        | DBMA-25ST            | DBMA-25ST-FO     | DBMAE-25ST           | DBMAE-25ST-FO    | DBMAY-25ST           | DBMAY-25ST-FO    |
| 37        | DCMA-37ST            | DCMA-37ST-FO     | DCMAE-37ST           | DCMAE-37ST-FO    | DCMAY-37ST           | DCMAY-37ST-FO    |
| 50        | DDMA-50ST            | DDMA-50ST-FO     | DDMAE-50ST           | DDMAE-50ST-FO    | DDMAY-50ST           | DDMAY-50ST-FO    |

4

### Crimp and Poke Machined Contacts

- Will accommodate 20, 22, and 24 AWG wire.



## Ordering Information

### Contacts

#### Description

|        |               |
|--------|---------------|
| Pin    | M39029/64-369 |
| Socket | M39029/63-368 |

**D-subminiature Metal Shell  
MIL-C-24308  
M24308 Series**



**FEATURES**

- *Meets all MIL-C-24308 Class G specifications.*
- *Offered in Crimp and Poke and Solder Cup and PCB vertical and right-angle.*
- *Offered in 9, 15, 25, 37, and 50 position plugs and sockets except right-angle (9 to 37 positions).*
- *Monoblock green diallyl phthalate insulator for improved electrical performance.*
- *See pages 4-5 thru 4-10 for standard dimensions, contact arrangements, and panel mounting specifications.*

**MATERIALS**

**Insulator Material:** Glass-filled diallyl phthalate (green) per MIL-M-14, Type SDG-F  
**Connector Shell:** Steel with cadmium plating and yellow chromate finish  
**Contact Material:** Plug - Brass (machined), Socket - Phosphor bronze (machined)  
**Contact Plating:** 50µin. gold over copper or nickel  
**Dual Float Bushing:** Stainless steel, passivated or non-magnetic brass

**ENVIRONMENTAL**

**Operating Temperature:** -65°C to + 125°C  
**Shock:** 50G peak per MIL-STD-202, Method 213, Condition G  
**Vibration:** 12 cycles in three perpendicular directions @ 10-2000Hz, per MIL-STD-202 Method 204, Condition D  
**Moisture Resistance:** 90-95% relative humidity @ 40°C for 96 hours per MIL-STD-202, Method 103

**ELECTRICAL**

**Withstanding Voltage:** Minimum 1250V RMS @ sea level  
**Current Rating:** 5 Amps  
**Contact Resistance:** 2.7 milliohms maximum  
**Insulation Resistance:** 5000 megohms maximum (initial); 1000 megohms (minimum) after environmental testing

**MECHANICAL**

**Individual Contact Insertion and Separation Force (minimum/maximum):** 0.7 oz./12 oz.  
**Durability:** 500 mating cycles



# D-subminiature Metal Shell MIL-C-24308 Crimp and Poke M24308 Series



- Available with .120 mounting holes, float bushings, or dual float bushings.
- Order with contacts included or separately.
- Order with contact Insertion/Extraction Tool included or order tool #CIET-20-HD separately. See page 4-103.



## Ordering Information

### Crimp and Poke Plugs

#### Steel Shell

##### Contacts Included. Insertion/Extraction Tool Not Included.

| Positions | Mounting Holes | Float Bushings | Dual Float Bushings |
|-----------|----------------|----------------|---------------------|
| 9         | M24308/4-1F    | M24308/4-302F  | M24308/4-435F       |
| 15        | M24308/4-2F    | M24308/4-303F  | M24308/4-436F       |
| 25        | M24308/4-3F    | M24308/4-304F  | M24308/4-437F       |
| 37        | M24308/4-4F    | M24308/4-305F  | M24308/4-438F       |
| 50        | M24308/4-5F    | M24308/4-306F  | M24308/4-439F       |

##### Contacts Included. Insertion/Extraction Tool Included.

| Positions | Mounting Holes | Float Bushings | Dual Float Bushings |
|-----------|----------------|----------------|---------------------|
| 9         | M24308/4-6F    | M24308/4-313F  | M24308/4-446F       |
| 15        | M24308/4-7F    | M24308/4-314F  | M24308/4-447F       |
| 25        | M24308/4-8F    | M24308/4-315F  | M24308/4-448F       |
| 37        | M24308/4-9F    | M24308/4-316F  | M24308/4-449F       |
| 50        | M24308/4-10F   | M24308/4-317F  | M24308/4-450F       |

##### Contacts Not Included. Insertion/Extraction Tool Not Included.

| Positions | Mounting Holes | Float Bushings | Dual Float Bushings |
|-----------|----------------|----------------|---------------------|
| 9         | M24308/4-259F  | M24308/4-324F  | M24308/4-457F       |
| 15        | M24308/4-260F  | M24308/4-325F  | M24308/4-458F       |
| 25        | M24308/4-261F  | M24308/4-326F  | M24308/4-459F       |
| 37        | M24308/4-262F  | M24308/4-327F  | M24308/4-460F       |
| 50        | M24308/4-263F  | M24308/4-328F  | M24308/4-461F       |

# D-subminiature Metal Shell MIL-C-24308 Crimp and Poke M24308 Series



## Ordering Information

### Crimp and Poke Sockets

#### Steel Shell

##### Contacts Included. Insertion/Extraction Tool Not Included.

| Positions | Mounting Holes | Float Bushings | Dual Float Bushings |
|-----------|----------------|----------------|---------------------|
| 9         | M24308/2-1F    | M24308/2-23F   | M24308/2-342F       |
| 15        | M24308/2-2F    | M24308/2-24F   | M24308/2-343F       |
| 25        | M24308/2-3F    | M24308/2-25F   | M24308/2-344F       |
| 37        | M24308/2-4F    | M24308/2-26F   | M24308/2-345F       |
| 50        | M24308/2-5F    | M24308/2-27F   | M24308/2-346F       |

##### Contacts Included. Insertion/Extraction Tool Included.

| Positions | Mounting Holes | Float Bushings | Dual Float Bushings |
|-----------|----------------|----------------|---------------------|
| 9         | M24308/2-6F    | M24308/2-34F   | M24308/2-353F       |
| 15        | M24308/2-7F    | M24308/2-35F   | M24308/2-354F       |
| 25        | M24308/2-8F    | M24308/2-36F   | M24308/2-355F       |
| 37        | M24308/2-9F    | M24308/2-37F   | M24308/2-356F       |
| 50        | M24308/2-10F   | M24308/2-38F   | M24308/2-357F       |

##### Contacts Not Included. Insertion/Extraction Tool Not Included.

| Positions | Mounting Holes | Float Bushings | Dual Float Bushings |
|-----------|----------------|----------------|---------------------|
| 9         | M24308/2-281F  | M24308/2-292F  | M24308/2-482F       |
| 15        | M24308/2-282F  | M24308/2-293F  | M24308/2-483F       |
| 25        | M24308/2-283F  | M24308/2-294F  | M24308/2-484F       |
| 37        | M24308/2-284F  | M24308/2-295F  | M24308/2-485F       |
| 50        | M24308/2-285F  | M24308/2-296F  | M24308/2-486F       |

4



# D-subminiature Metal Shell MIL-C-24308 Crimp and Poke M24308 Series



## Ordering Information

### Tooling

- Contact Insertion/Extraction Tool: #CIET-20-HD (Military #M81969/39-01). See page 4-103.
- Wire termination hand tool: #M22520/2-01. See page 4-103.
- Positioner for machine contacts for hand tool #M22520/2-08 (locates contact in the correct position). See page 4-103.

### Crimp and Poke Contacts



## Ordering Information

- Will accommodate 20, 22, and 24 AWG wire.

| Description |               |
|-------------|---------------|
| Pin         | M39029/64-369 |
| Socket      | M39029/63-368 |

# D-subminiature Metal Shell MIL-C-24308 Solder Cup M24308 Series



- Available with .120" mounting holes, float bushings, or dual float bushings.
- Will accommodate up to 20 AWG wire.



## Ordering Information

### Solder Cup Plugs

#### Steel Shell

| Positions | Mounting Holes | Float Bushings | Dual Float Bushings |
|-----------|----------------|----------------|---------------------|
| 9         | M24308/3-1F    | M24308/3-12F   | M24308/3-17F        |
| 15        | M24308/3-2F    | M24308/3-13F   | M24308/3-18F        |
| 25        | M24308/3-3F    | M24308/3-14F   | M24308/3-19F        |
| 37        | M24308/3-4F    | M24308/3-15F   | M24308/3-20F        |
| 50        | M24308/3-5F    | M24308/3-16F   | M24308/3-21F        |

#### Brass Non-Magnetic Shell

| Positions | Mounting Holes | Float Bushings | Dual Float Bushings |
|-----------|----------------|----------------|---------------------|
| 9         | M24308/7-1F    | M24308/7-12F   | M24308/7-17F        |
| 15        | M24308/7-2F    | M24308/7-13F   | M24308/7-18F        |
| 25        | M24308/7-3F    | M24308/7-14F   | M24308/7-19F        |
| 37        | M24308/7-4F    | M24308/7-15F   | M24308/7-20F        |
| 50        | M24308/7-5F    | M24308/7-16F   | M24308/7-21F        |

### Solder Cup Sockets

#### Steel Shell

| Positions | Mounting Holes | Float Bushings | Dual Float Bushings |
|-----------|----------------|----------------|---------------------|
| 9         | M24308/1-1F    | M24308/1-12F   | M24308/1-23F        |
| 15        | M24308/1-2F    | M24308/1-13F   | M24308/1-24F        |
| 25        | M24308/1-3F    | M24308/1-14F   | M24308/1-25F        |
| 37        | M24308/1-4F    | M24308/1-15F   | M24308/1-26F        |
| 50        | M24308/1-5F    | M24308/1-16F   | M24308/1-27F        |

#### Brass Non-Magnetic Shell

| Positions | Mounting Holes | Float Bushings | Dual Float Bushings |
|-----------|----------------|----------------|---------------------|
| 9         | M24308/5-1F    | M24308/5-12F   | M24308/5-23F        |
| 15        | M24308/5-2F    | M24308/5-13F   | M24308/5-24F        |
| 25        | M24308/5-3F    | M24308/5-14F   | M24308/5-25F        |
| 37        | M24308/5-4F    | M24308/5-15F   | M24308/5-26F        |
| 50        | M24308/5-5F    | M24308/5-16F   | M24308/5-27F        |

# D-subminiature Metal Shell MIL-C-24308 PCB M24308 Series



## Right-Angle Connector

- .283" footprint requires minimal PCB space.
- Available with three contact tail lengths (.127", .158", and .183") with .030" contact diameter.
- Available with two contact tail lengths (.127" and .183") with .040" contact diameter.
- Offered with .120" mounting holes.
- Mounting bracket: Black nylon. Can be removed if necessary.

Right-Angle



## Ordering Information

### Right-Angle PCB Plugs (Sockets not available)

#### Steel Shell

| Positions | .127 Tail Length      |                       |                       | .183 Tail Length      |                       |
|-----------|-----------------------|-----------------------|-----------------------|-----------------------|-----------------------|
|           | .030 Contact Diameter | .030 Contact Diameter | .030 Contact Diameter | .040 Contact Diameter | .040 Contact Diameter |
| 9         | M24308/24-25F         | M24308/24-31F         | M24308/24-49F         | M24308/24-37F         | M24308/24-55F         |
| 15        | M24308/24-26F         | M24308/24-32F         | M24308/24-50F         | M24308/24-38F         | M24308/24-56F         |
| 25        | M24308/24-27F         | M24308/24-33F         | M24308/24-51F         | M24308/24-39F         | M24308/24-57F         |
| 37        | M24308/24-28F         | M24308/24-34F         | M24308/24-52F         | M24308/24-40F         | M24308/24-58F         |

## Vertical Connector

- Available with two contact tail lengths (.158" and .183") and two contact diameters (.030" and .040").
- Offered with .120" mounting holes.

Vertical



## Ordering Information

### Vertical PCB Plugs

#### Steel Shell

| Positions | .158 Tail Length      |                       | .183 Tail Length      |                       |
|-----------|-----------------------|-----------------------|-----------------------|-----------------------|
|           | .030 Contact Diameter | .030 Contact Diameter | .040 Contact Diameter | .040 Contact Diameter |
| 9         | M24308/24-1F          | M24308/24-7F          | M24308/24-13F         | M24308/24-19F         |
| 15        | M24308/24-2F          | M24308/24-8F          | M24308/24-14F         | M24308/24-20F         |
| 25        | M24308/24-3F          | M24308/24-9F          | M24308/24-15F         | M24308/24-21F         |
| 37        | M24308/24-4F          | M24308/24-10F         | M24308/24-16F         | M24308/24-22F         |
| 50        | M24308/24-5F          | M24308/24-11F         | M24308/24-17F         | M24308/24-23F         |

## Vertical PCB Sockets

#### Steel Shell

| Positions | .158 Tail Length      |                       | .183 Tail Length      |                       |
|-----------|-----------------------|-----------------------|-----------------------|-----------------------|
|           | .030 Contact Diameter | .030 Contact Diameter | .040 Contact Diameter | .040 Contact Diameter |
| 9         | M24308/23-1F          | M24308/23-7F          | M24308/23-13F         | M24308/23-19F         |
| 15        | M24308/23-2F          | M24308/23-8F          | M24308/23-14F         | M24308/23-20F         |
| 25        | M24308/23-3F          | M24308/23-9F          | M24308/23-15F         | M24308/23-21F         |
| 37        | M24308/23-4F          | M24308/23-10F         | M24308/23-16F         | M24308/23-22F         |
| 50        | M24308/23-5F          | M24308/23-11F         | M24308/23-17F         | M24308/23-23F         |

Cinch backshells are offered in a variety of styles, each having a specific strength.

- **Backshells** have two-piece construction and are frequently used where appearance is a major factor. RFI/EMI shielding capability is also an option:
  - Plastic Backshells: No shielding.
  - Metallized Plastic: Economical method of shielding.
  - Diecast Backshells: Maximum shielding.
- Cinch **SDH Series** backshells utilize Cinch's Latch-N-Lock™ system with quick release disconnect. Just squeeze the latch levers to release the connector. Also available with standard 4-40 mounting hardware.
- **Junction Shells** come in a variety of sizes and shapes including right-angle and low profile. They are generally of one-piece construction with an adjustable clamp, but there is no shielding.
- **Hoods** have an improved appearance versus junction shells but no shielding. They are all-plastic and come in right-angle or straight configurations.
- **Hardware**, in the form of adjustable grommets or strain relief clamps and 4-40 screws, is generally supplied with the product; however, a variety of optional hardware is also available in the accessories section of this catalog.

# D-subminiature Backshells/Junction Shells/Hoods Accessories



The following is a summary of the various backshells, junction shells, and hoods that Cinch offers:

## Backshells

| Type  | 2-Piece | 2-Piece    | 2-Piece   | 2-Piece  | Super-D Connection System |              |
|---|---------|------------|-----------|----------|---------------------------|--------------|
| Material                                      | Plastic | Metallized | Diecast   | Diecast  | Black Plastic             | Gray Plastic |
| Series  | DPH     | DCH        | DMH       | Ethernet | SDH - B                   | SDH - G      |
| Shell Sizes*                                  | E A B C | E A B C D  | E A B C D | A        | E A B C                   | E A B C      |
| Cable Exit                                    | 180°    | 180°       | 180°      | 90°/180° | 90°/180°                  | 90°/180°     |
| <b>Fits Connector Series marked with “●”:</b> |         |            |           |          |                           |              |
| D*A Series                                    | ●       | ●          | ●         | ●        | ●                         |              |
| HTD Series                                    | ●       | ●          | ●         |          |                           |              |
| D*U Series                                    | ●       | ●          | ●         | ●        | ●                         |              |
| Series 3                                      | ●       | ●          | ●         | ●        | ●                         |              |
| T Series Metal Shell                          | ●       | ●          | ●         | ●        | ●                         |              |
| T Series All-Plastic                          |         |            |           |          |                           | ●            |
| Basic D                                       | ●       | ●          | ●         | ●        | ●                         |              |
| Series 1                                      | ●       | ●          | ●         | ●        | ●                         |              |

## Junction Shells/Hoods

| Type  | Junction Shells |             |                 |                     |                 | Hoods    |                  |                   |
|---|-----------------|-------------|-----------------|---------------------|-----------------|----------|------------------|-------------------|
|   | Straight Clamp  | Round Clamp | Rt. Angle Clamp | Deep Straight Clamp | Switching Shell | Phenolic | Straight Plastic | Rt. Angle Plastic |
| Material                                      | Metal           | Metal       | Metal           | Metal               | Metal           | Plastic  | Plastic          | Plastic           |
| Shell Sizes*                                  | A B C D         | A B C D     | E A B C D       | E A B C D           | A B C D         | A B      | E A B            | A B               |
| Cable Exit                                    | 180°            | 180°        | 90°             | 180°                | 180°            | 180°     | 180°             | 90°               |
| <b>Fits Connector Series marked with “●”:</b> |                 |             |                 |                     |                 |          |                  |                   |
| D*A Series                                    | ●               | ●           | ●               | ●                   | ●               | ●        | ●                | ●                 |
| D*U Series                                    | ●               | ●           | ●               | ●                   | ●               | ●        | ●                | ●                 |
| Series 3                                      | ●               | ●           | ●               | ●                   | ●               | ●        | ●                | ●                 |
| T Series Metal Shell                          | ●               | ●           | ●               | ●                   | ●               | ●        | ●                | ●                 |
| T Series All-Plastic                          |                 |             |                 |                     |                 |          |                  |                   |
| Basic D Series                                | ●               | ●           | ●               | ●                   | ●               | ●        | ●                | ●                 |
| Series 1                                      | ●               | ●           | ●               | ●                   | ●               | ●        | ●                | ●                 |

\*Conversion Chart between Standard Density Connectors and HPD/HTD Series 1.5 Density Connectors

| Shell Size | Standard D-sub | 1.5 D-Sub HTD |
|------------|----------------|---------------|
| E          | 9              | 15            |
| A          | 15             | 26            |
| B          | 25             | 44            |
| C          | 37             | 62            |
| D          | 50             | N/A           |

# D-subminiature Backshells - Two-Piece D\*H Series



- Standard two-piece construction available in plastic, metallized plastic, or diecast zinc versions with 180° straight cable entry.
- Fits standard metal shell D-subminiature plugs and sockets as well as HTD Series 1.5 D-sub.
- Ethernet hoods are available in diecast 15 position versions only with both 90° and 180° cable entry.
- Included in all backshells:
  - Hardware: 4-40 screws, hex nuts, 4-40 screw mounting bracket.
  - Grommets: To accommodate most cable sizes. Grommets also function as strain reliefs.
- Backshells are individually bagged.
- Note that slide locks may not be used with these backshells.
- Optional thumbscrew for backshell must be ordered separately if required.

## Materials

- 4-40 screws, hex nuts, mounting bracket: Steel with zinc plating and clear chromate coating.
- Standard Backshells:
  - Plastic Backshells: ABS (black), hardware - steel with zinc plating, grommets - polyphenylene, (black).
  - Metallized Plastic Backshells: ABS with nickel over copper plating, hardware - steel with zinc plating, grommets - PVC (black).
  - Diecast Backshells: Diecast zinc, grommets - PVC (black).
- Ethernet Backshells: Diecast zinc, grommets - PVC (black).

4



Plastic



Metallized



Diecast



Ethernet Straight



Ethernet Right-Angle

# D-subminiature Backshells - Two-Piece D\*H Series



## Straight (180°) Standard Backshells

### Plastic and Metallized Plastic Backshells



### Dimensions

| Shell Size | A     |       | B     |       | C     |       | D     |       | E     |       | F     |       |
|------------|-------|-------|-------|-------|-------|-------|-------|-------|-------|-------|-------|-------|
|            | in    | mm    | in    | mm    | in    | mm    | in    | mm    | in    | mm    | in    | mm    |
| E          | 1.225 | 31.12 | 1.547 | 39.29 | 0.640 | 16.26 | 0.645 | 16.38 | 0.400 | 10.16 | 0.984 | 24.99 |
| A          | 1.540 | 39.12 | 1.516 | 38.51 | 0.640 | 16.26 | 0.645 | 16.38 | 0.400 | 10.16 | 1.312 | 33.32 |
| B          | 2.090 | 53.09 | 1.655 | 42.04 | 0.710 | 18.03 | 0.645 | 16.38 | 0.522 | 13.26 | 1.857 | 47.17 |
| C          | 2.730 | 69.34 | 1.830 | 46.48 | 0.906 | 23.01 | 0.645 | 16.38 | 0.725 | 18.42 | 2.500 | 63.50 |
| D          | 2.645 | 67.18 | 1.855 | 41.12 | 0.940 | 23.88 | 0.750 | 19.05 | 0.725 | 18.42 | 2.406 | 61.11 |



# D-subminiature Backshells - Two-Piece D\*H Series



## EMI/RFI Shielded Diecast Backshells

### 9 and 15 Position

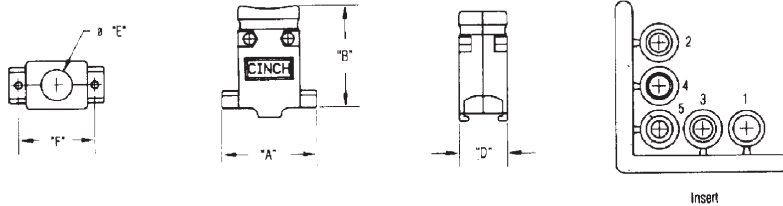

### 25 Position



### 37 and 50 Position

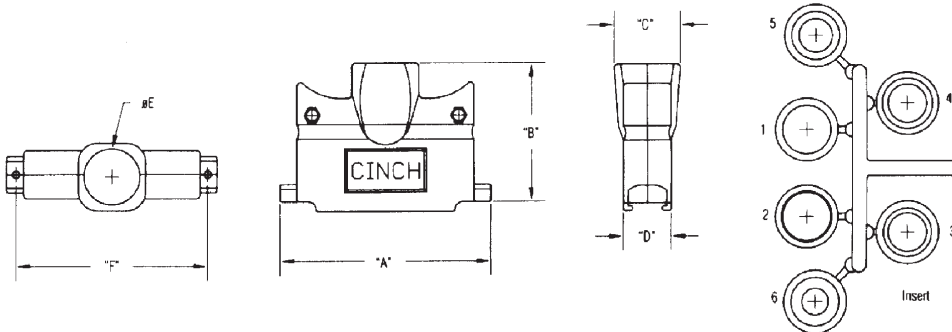

## Dimensions

| Shell Size | A     |       | B     |       | C     |       | D     |       | E     |       | F     |       |
|------------|-------|-------|-------|-------|-------|-------|-------|-------|-------|-------|-------|-------|
|            | in    | mm    | in    | mm    | in    | mm    | in    | mm    | in    | mm    | in    | mm    |
| E          | 1.225 | 31.12 | 1.465 | 37.21 | 0.620 | 15.75 | 0.620 | 15.75 | 0.400 | 10.16 | 0.984 | 24.99 |
| A          | 1.540 | 39.12 | 1.600 | 40.64 | 0.620 | 15.75 | 0.620 | 15.75 | 0.400 | 10.16 | 1.312 | 33.32 |
| B          | 2.090 | 53.09 | 1.570 | 39.88 | 0.690 | 17.53 | 0.620 | 15.75 | 0.525 | 13.34 | 1.857 | 47.17 |
| C          | 2.730 | 69.34 | 1.810 | 45.97 | 0.862 | 21.89 | 0.620 | 15.75 | 0.725 | 18.42 | 2.500 | 63.50 |
| D          | 2.624 | 66.65 | 1.800 | 45.72 | 0.862 | 21.89 | 0.730 | 18.54 | 0.725 | 18.42 | 2.406 | 61.11 |

## Ordering Information

### D\*H Two-Piece Backshells

| Shell Size | Fits             |                 | Cable Entry Style | Plastic   | Cable Dia. (in) | Metallized Plastic | Cable Dia. (in) | Diecast Metal | Cable Dia. (in) |
|------------|------------------|-----------------|-------------------|-----------|-----------------|--------------------|-----------------|---------------|-----------------|
|            | Standard Density | HTD 1.5 Density |                   |           |                 |                    |                 |               |                 |
| E          | 9                | 15              | Straight (180°)   | DPH-E-001 | .210-.320       | DCH-E-001          | .210-.350       | DMH-E-001     | .210-.320       |
| A          | 15               | 26              | Straight (180°)   | DPH-A-001 | .210-.320       | DCH-A-001          | .210-.350       | DMH-A-001     | .210-.320       |
| B          | 25               | 44              | Straight (180°)   | DPH-B-001 | .230-.450       | DCH-B-001          | .230-.450       | DMH-B-001     | .230-.450       |
| C          | 37               | 62              | Straight (180°)   | DPH-C-001 | .350-.650       | DCH-C-001          | .350-.640       | DMH-C-001     | .350-.650       |
| D          | 50               | N/A             | Straight (180°)   | DPH-D-001 | .350-.650       | DCH-D-001          | .350-.640       | DMH-D-001     | .350-.640       |



# D-subminiature Backshells - Two-Piece D\*H Series



## Straight (180°) Diecast Ethernet Backshells



Type 2

## Right-Angle (90°) Diecast Ethernet Backshells



## Ordering Information

### D\*H Ethernet Diecast Backshells

| Fits Shell Size | Fits Standard Density | Cable Diameter (in) | Cable Entry Style |             | A     |       | B     |       | C     |       | D    |       | E     |       | F     |       |
|-----------------|-----------------------|---------------------|-------------------|-------------|-------|-------|-------|-------|-------|-------|------|-------|-------|-------|-------|-------|
|                 |                       |                     |                   |             | in    | mm    | in    | mm    | in    | mm    | in   | mm    | in    | mm    | in    | mm    |
| A               | 15                    | .210-.320           | Straight (180°)   | DMH-A-001XL | 1.550 | 39.37 | 1.880 | 47.75 | 0.710 | 18.03 | 0.64 | 16.26 | 0.522 | 13.26 | 1.312 | 33.32 |
| A               | 15                    | .210-.320           | Rt. Angle (90°)   | DMH-A-901X  | 1.550 | 39.37 | 1.880 | 47.75 | 0.710 | 18.03 | 0.64 | 16.26 | 0.522 | 13.26 | 1.312 | 33.32 |



### THUMBSCREWS (OPTIONAL) FOR D\*H BACKSHELLS

Order #4-40-THMB-1 (two each required per backshell).

(Will not work with ethernet type backshells)

## D-subminiature Backshells - Super D SDH Series



### FEATURES

- *The Cinch Super D Interconnection System is a simple, fast, economical, and reliable way for mating connectors from cable to cable or cable to panel.*
- *Snap-on Super D plastic hoods captivate connectors providing positive, self-latching, audible mating with reliable retention and Latch-N-Lock quick release disconnect.*
- *Snap-on Super-D plastic hoods are also available with filler ends to utilize 4-40 mounting hardware.*
- *Super D hoods are available:*
  - *Straight (180°) or Right-Angle (90°) cable entry.*
  - *Sizes: 9, 15, 25, and 37.*
  - *Sizes 15, 25, and 37 are available in standard or large cable openings.*
- *Black SDH backshells accommodate any standard metal shell IDC, solder cup, or crimp and poke D-subminiature connector.*
- *Gray SDH backshells accommodate the Cinch All-Plastic IDC T-Series connector on pages 4-38 thru 4-39.*
- *Each Super-D plastic hood includes a stay band to strain relief the cable wire. Stay band tool SD-MSBT is required. Extra stay bands are available on page 4-90.*

### MATERIALS

**Hood:** Modified phenylene oxide - black for metal shell connectors or gray for all-plastic IDC connectors

**Latch Block:** Diecast zinc

**Screws for Latching Blocks:** Steel with nickel plating

**Stay Band:** Steel with zinc plating and clear chromate finish



# D-subminiature Backshells - For use with Metal Shell Connectors SDH Series



## Straight (180°) Cable Entry Black Backshells for Metal Shell Connectors

Adapter Hood with Filler Ends



Adapter Hood with Latches



## Right-Angle (90°) Cable Entry Black Backshells for Metal Shell Connectors

Right-Angle Adapter Hood



### Dimensions

| Positions | A $\pm .020$ " (.58mm) |       | B $\pm .020$ " (.58mm) |      | C $\pm .020$ " (.58mm) |       | D $\pm .020$ " (.58mm) |       | E $\pm .020$ " (.58mm) |       |
|-----------|------------------------|-------|------------------------|------|------------------------|-------|------------------------|-------|------------------------|-------|
|           | in                     | mm    | in                     | mm   | in                     | mm    | in                     | mm    | in                     | mm    |
| 9         | 1.47                   | 37.34 | .31                    | 7.87 | -                      | -     | 1.94                   | 49.21 | 1.25                   | 31.75 |
| 15        | 1.80                   | 45.72 | .31                    | 7.87 | .41                    | 10.41 | 2.25                   | 57.15 | 1.34                   | 34.13 |
| 25        | 2.35                   | 59.69 | .33                    | 8.40 | .47                    | 11.94 | 2.94                   | 74.61 | 1.50                   | 38.10 |
| 37        | 2.99                   | 75.95 | .37                    | 9.40 | .50                    | 12.70 | 3.59                   | 91.28 | 1.53                   | 38.89 |



# D-subminiature Backshells - For use with Metal Shell Connectors SDH Series



## Ordering Information

### Straight (180°) Cable Entry Black Backshells for Metal Shell Connectors

| Positions | Latches                |                     | Filler Ends            |                     | Filler Ends w/4-40 Screws |                     |
|-----------|------------------------|---------------------|------------------------|---------------------|---------------------------|---------------------|
|           | Standard Cable Opening | Large Cable Opening | Standard Cable Opening | Large Cable Opening | Standard Cable Opening    | Large Cable Opening |
| 9         | SDH-9BL                | N/A                 | SDH-9BF                | N/A                 | SDH-9BFCS                 | N/A                 |
| 15        | SDH-15BL               | SDH-15BLL           | SDH-15BF               | SDH-15BFL           | SDH-15BFCS                | SDH-15BFLCS         |
| 25        | SDH-25BL               | SDH-25BLL           | SDH-25BF               | SDH-25BFL           | SDH-25BFCS                | SDH-25BFLCS         |
| 37        | SDH-37BL               | SDH-37BLL           | SDH-37BF               | SDH-37BFL           | SDH-37BFCS                | SDH-37BFLCS         |

### Right-Angle (90°) Cable Entry Black Backshells for Metal Shell Connectors

## Ordering Information

| Positions | Latches                |                     |
|-----------|------------------------|---------------------|
|           | Standard Cable Opening | Large Cable Opening |
| 9         | SDH-9RBL               | N/A                 |
| 15        | SDH-15RBL              | SDH-15RBLL          |
| 25        | SDH-25RBL              | SDH-25RBLL          |
| 37        | SDH-37RBL              | SDH-37RBLL          |

### Latching Blocks for Super D Adapter System



## Ordering Information

| Description                                | For Panel Thickness | Qty per pack | Qty Required Per SDH Hood | Catalog Number |
|--|---------------------|--------------|---------------------------|----------------|
| Latching Block                             | N/A                 | 1 each       | 2 each                    | SD-LB          |
| Latching Block with SEM Screws             | Up to .060"         | 2 each       | 2 each                    | SD-LB-060      |
| Removable Mounting Screws for Adapter Hood | N/A                 | 1 each       | 2 each                    | 4-40UNC2AX3/4  |
| Latching Block with SEM Screws             | .060" to .080"      | 2 each       | 2 each                    | SD-LB-060-080  |
| Latching Block with SEM Screws             | .080" to .125"      | 2 each       | 2 each                    | SD-LB-125      |

# D-subminiature Backshells - Gray with All-Plastic Connectors SDH Series



- Fits only T Series All-Plastic IDC connector on pages 4-38 thru 4-39.

## Straight (180°) Cable Entry Gray Backshells for All-Plastic Connectors



### Dimensions

| Positions | A ±.020" (.58mm) |       | B ±.020" (.58mm) |      | C ±.020" (.58mm) |       |
|-----------|------------------|-------|------------------|------|------------------|-------|
|           | in               | mm    | in               | mm   | in               | mm    |
| 9         | 1.47             | 37.34 | .31              | 7.87 | ---              | ---   |
| 15        | 1.80             | 45.72 | .31              | 7.87 | .41              | 10.41 |
| 25        | 2.35             | 59.69 | .33              | 8.40 | .47              | 11.94 |
| 37        | 2.99             | 75.95 | .37              | 9.40 | .50              | 12.70 |

### Ordering Information

#### Straight (180°) Cable Entry Gray Backshells for All-Plastic Connectors

| Positions | Latches                |                     | Filler Ends            |                     | Filler Ends w/4-40 Screws |                     |
|-----------|------------------------|---------------------|------------------------|---------------------|---------------------------|---------------------|
|           | Standard Cable Opening | Large Cable Opening | Standard Cable Opening | Large Cable Opening | Standard Cable Opening    | Large Cable Opening |
| 9         | SDH-9GL                | N/A                 | SDH-9GF                | N/A                 | SDH-9GFCS                 | N/A                 |
| 15        | SDH-15GL               | SDH-15GLL           | SDH-15GF               | SDH-15GFL           | SDH-15GFCS                | SDH-15GFLCS         |
| 25        | SDH-25GL               | SDH-25GLL           | SDH-25GF               | SDH-25GFL           | SDH-25GFCS                | SDH-25GFLCS         |
| 37        | SDH-37GL               | SDH-37GLL           | SDH-37GF               | SDH-37GFL           | SDH-37GFCS                | SDH-37GFLCS         |



# D-subminiature Backshells - Gray use with All-Plastic Connectors SDH Series



## Right-Angle (90°) Cable Entry Gray Backshells for All-Plastic Connectors

- Fits only IDC connectors on pages 4-38 thru 4-39.



### Dimensions

| Positions | A ±.020" (.58mm) |       | B ±.020" (.58mm) |      | C ±.020" (.58mm) |       | D ±.020" (.58mm) |       |
|-----------|------------------|-------|------------------|------|------------------|-------|------------------|-------|
|           | in               | mm    | in               | mm   | in               | mm    | in               | mm    |
| 9         | 1.94             | 49.21 | .31              | 7.87 | --               | ---   | 1.25             | 31.75 |
| 15        | 2.25             | 57.15 | .31              | 7.87 | .41              | 10.41 | 1.34             | 34.13 |
| 25        | 2.94             | 74.61 | .33              | 8.40 | .47              | 11.94 | 1.50             | 38.10 |
| 37        | 3.59             | 91.28 | .37              | 9.40 | .50              | 12.70 | 1.53             | 38.89 |

### Ordering Information

#### Right-Angle (90°) Cable Entry Gray Backshells for All-Plastic Connectors

| Positions | Latches                |                     |
|-----------|------------------------|---------------------|
|           | Standard Cable Opening | Large Cable Opening |
| 9         | SDH-9RGL               | N/A                 |
| 15        | SDH-15RGL              | SDH-15RGLL          |
| 25        | SDH-25RGL              | SDH-25RGLL          |
| 37        | SDH-37RGL              | SDH-37RGLL          |

### Ordering Information

#### Accessories for Gray Backshells

| Positions | Optional        | Additional   |
|-----------|-----------------|--------------|
|           | Strain Reliefs* | Stay Bands** |
| 9         | SD-WC9          | SD-9-15-SB   |
| 15        | SD-WC15         | SD-9-15-SB   |
| 25        | SD-WC25         | SD-25-37-SB  |
| 37        | SD-WC37         | SD-25-37-SB  |

\* Two each required per backshell.

\*\* Stay band tool #SD-MSBT required. See page 4-100..



**Screw for screwlocking connector assembly - (2 each required):** 4-40UNC2AX3/4.

See page 4-85 for latch block drawing.

- **Shell Material:** Zinc-plated low carbon steel with yellow chromate finish.
- **Clamp:** Zinc-plated steel with yellow chromate finish.
- **Screw:** Zinc-plated steel with yellow chromate finish.
- **Stop Nut:** Zinc-plated brass with yellow chromate finish.

## Straight Clamp



| Shell Size | Positions | A     |       | B    |       | C     |       | E    |      | F    |       | G    |       |
|------------|-----------|-------|-------|------|-------|-------|-------|------|------|------|-------|------|-------|
|            |           | in    | mm    | in   | mm    | in    | mm    | in   | mm   | in   | mm    | in   | mm    |
| A          | 15        | 1.531 | 38.89 | .500 | 12.70 | 1.312 | 33.32 | .296 | 7.52 | .312 | 7.92  | .640 | 16.26 |
| B          | 25        | 2.078 | 52.78 | .500 | 12.70 | 1.852 | 47.04 | .296 | 7.52 | .796 | 20.22 | .640 | 16.26 |
| C          | 37        | 2.718 | 69.04 | .500 | 12.70 | 2.500 | 63.50 | .296 | 7.52 | .687 | 17.45 | .640 | 16.26 |
| D          | 50        | 2.625 | 66.68 | .609 | 15.47 | 2.406 | 61.11 | .390 | 9.91 | .687 | 17.45 | .703 | 17.86 |

## Round Clamp



| Shell Size | Positions | A     |       | B    |       | C     |       | D    |       | E     |       | F    |      | G     |       |
|------------|-----------|-------|-------|------|-------|-------|-------|------|-------|-------|-------|------|------|-------|-------|
|            |           | in    | mm    | in   | mm    | in    | mm    | in   | mm    | in    | mm    | in   | mm   | in    | mm    |
| A          | 15        | 1.531 | 38.89 | .500 | 12.70 | 1.312 | 33.32 | .406 | 10.31 | .984  | 23.72 | .125 | 3.18 | 1.031 | 26.19 |
| B          | 25        | 2.078 | 52.78 | .500 | 12.70 | 1.852 | 47.04 | .593 | 15.06 | 1.515 | 38.48 | .187 | 4.75 | 1.062 | 26.97 |

## Right-Angle Clamp



| Shell Size | Positions | A     |       | B     |       | C     |       | E    |       | F    |       | G    |       | H    |      |
|------------|-----------|-------|-------|-------|-------|-------|-------|------|-------|------|-------|------|-------|------|------|
|            |           | in    | mm    | in    | mm    | in    | mm    | in   | mm    | in   | mm    | in   | mm    | in   | mm   |
| E          | 9         | 1.203 | 30.56 | 0.718 | 18.24 | .984  | 24.99 | .437 | 11.10 | .437 | 11.10 | .468 | 11.89 | .281 | 7.14 |
| A          | 15        | 1.531 | 38.89 | 0.718 | 18.24 | 1.312 | 33.32 | .437 | 11.10 | .437 | 11.10 | .468 | 11.89 | .281 | 7.14 |
| B          | 25        | 2.078 | 52.78 | 0.968 | 24.59 | 1.852 | 47.04 | .437 | 11.10 | .625 | 15.88 | .468 | 11.89 | .281 | 7.14 |
| C          | 37        | 2.718 | 69.04 | 1.187 | 30.15 | 2.500 | 63.50 | .437 | 11.10 | .812 | 20.62 | .468 | 11.89 | .281 | 7.14 |
| D          | 50        | 2.625 | 66.68 | 1.250 | 31.75 | 2.406 | 61.11 | .562 | 14.27 | .906 | 23.01 | .531 | 13.49 | .343 | 8.71 |

# D-subminiature Junction Shells



## Deep Straight Clamp



| Shell Size | Positions | A     |       | B    |       | C     |       | D    |       | E     |       | F    |       | G     |       | H     |       |
|------------|-----------|-------|-------|------|-------|-------|-------|------|-------|-------|-------|------|-------|-------|-------|-------|-------|
|            |           | in    | mm    | in   | mm    | in    | mm    | in   | mm    | in    | mm    | in   | mm    | in    | mm    | in    | mm    |
| E          | 9         | 1.203 | 30.56 | .484 | 12.29 | 0.984 | 24.99 | .578 | 14.68 | .375  | 9.53  | .375 | 9.53  | .750  | 19.05 | 1.219 | 30.96 |
| A          | 15        | 1.531 | 38.89 | .484 | 12.29 | 1.312 | 33.32 | .578 | 14.68 | .713  | 18.11 | .312 | 7.92  | .750  | 19.05 | 1.250 | 31.75 |
| B          | 25        | 2.078 | 52.78 | .484 | 12.29 | 1.852 | 47.04 | .578 | 14.68 | 1.000 | 25.40 | .312 | 7.92  | 1.000 | 25.40 | 1.531 | 38.89 |
| C          | 37        | 2.718 | 69.04 | .484 | 12.29 | 2.500 | 63.50 | .578 | 14.68 | 1.375 | 34.93 | .312 | 7.92  | 1.000 | 25.40 | 1.531 | 38.89 |
| D          | 50        | 2.625 | 66.68 | .593 | 15.06 | 2.406 | 61.11 | .687 | 17.45 | 1.406 | 35.71 | .406 | 10.31 | 1.125 | 28.58 | 1.656 | 42.06 |

## Switching Shell



| Shell Size | Positions | A     |       | B    |       | C     |       |
|------------|-----------|-------|-------|------|-------|-------|-------|
|            |           | in    | mm    | in   | mm    | in    | mm    |
| A          | 15        | 1.531 | 38.89 | .500 | 12.70 | 1.312 | 33.32 |
| B          | 25        | 2.078 | 52.78 | .500 | 12.70 | 1.852 | 47.04 |
| C          | 37        | 2.718 | 69.04 | .500 | 12.70 | 2.500 | 63.50 |
| D          | 50        | 2.625 | 66.68 | .609 | 15.47 | 2.406 | 61.11 |

## Ordering Information

### Junction Shells - Metal

| Shell Size | Fits             |                |             |                   |                     |                 |
|------------|------------------|----------------|-------------|-------------------|---------------------|-----------------|
|            | Standard Density | Straight Clamp | Round Clamp | Right-Angle Clamp | Deep Straight Clamp | Switching Shell |
| E          | 9                | N/A            | N/A         | DE-19977-5        | DE-24657            | N/A             |
| A          | 15               | DA-19678-1     | DA-20961    | DA-19977-1        | DA-24658            | DA-19678-6      |
| B          | 25               | DB-19678-2     | DB-20962    | DB-19977-2        | DB-24659            | DB-19678-7      |
| C          | 37               | DC-19678-3     | N/A         | DC-19977-3        | DC-24660            | DC-19678-8      |
| D          | 50               | DD-19678-4     | N/A         | DD-19977-4        | DD-24661            | DD-19678-9      |



# D-subminiature Plastic Hoods



## Phenolic Hood

Shell Material: Phenolic (black).  
#4-40 Screws: Steel with nickel plating.

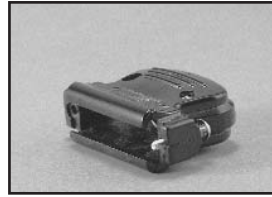

| Shell Size | Positions | A     |       | B     |       | C    |      | D     |       | E     |       |
|------------|-----------|-------|-------|-------|-------|------|------|-------|-------|-------|-------|
|            |           | in    | mm    | in    | mm    | in   | mm   | in    | mm    | in    | mm    |
| A          | 15        | 1.297 | 32.94 | 1.219 | 30.96 | .266 | 6.76 | 1.312 | 33.32 | 1.641 | 41.68 |
| B          | 25        | 1.406 | 35.71 | 1.797 | 45.64 | .328 | 8.33 | 1.852 | 47.04 | 2.203 | 55.96 |

## All-Plastic Straight (180°) Hood

Shell Material: Nylon (gray).  
#4-40 Screws: Steel with nickel plating.



Connector Not Included



| Shell Size | Positions | A     |       | B     |       | C     |       | D    |       | E    |       | F    |       | G    |      |
|------------|-----------|-------|-------|-------|-------|-------|-------|------|-------|------|-------|------|-------|------|------|
|            |           | in    | mm    | in    | mm    | in    | mm    | in   | mm    | in   | mm    | in   | mm    | in   | mm   |
| E          | 9         | 1.218 | 30.94 | 1.000 | 25.40 | .984  | 23.72 | .500 | 12.70 | .562 | 14.27 | .281 | 7.14  | .218 | 7.14 |
| A          | 15        | 1.546 | 38.27 | 1.000 | 25.40 | 1.312 | 33.32 | .500 | 12.70 | .562 | 14.27 | .360 | 9.14  | .360 | 9.14 |
| B          | 25        | 2.093 | 53.16 | 1.250 | 31.75 | 1.852 | 47.04 | .500 | 12.70 | .562 | 14.27 | .493 | 12.52 | .360 | 9.14 |

## All-Plastic Right-Angle (90°) Hood

Shell Material: Nylon (gray).  
#4-40 Screws: Steel with nickel plating.



Connector Not Included

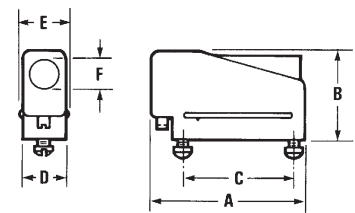

| Shell Size | Positions | A     |       | B     |       | C     |       | D    |       | E    |       | F    |      |
|------------|-----------|-------|-------|-------|-------|-------|-------|------|-------|------|-------|------|------|
|            |           | in    | mm    | in    | mm    | in    | mm    | in   | mm    | in   | mm    | in   | mm   |
| A          | 15        | 1.822 | 46.28 | 1.000 | 25.40 | 1.312 | 33.32 | .500 | 12.70 | .562 | 14.28 | .360 | 9.14 |
| B          | 25        | 2.368 | 60.15 | 1.250 | 31.75 | 1.852 | 47.04 | .500 | 12.70 | .562 | 14.28 | .360 | 9.14 |

## Ordering Information

### Plastic Hoods

| Shell Size | Standard Density | Phenolic Hood | Straight Hood | Right Angle |
|------------|------------------|---------------|---------------|-------------|
| E          | 9                | N/A           | DE-51218-1    | N/A         |
| A          | 15               | DA-51225-1    | DA-51210-1    | DA-51211-1  |
| B          | 25               | DB-51226-1A   | DB-51212-1    | DB-51213-1  |
| C          | 37               | N/A           | N/A           | N/A         |
| D          | 50               | N/A           | N/A           | N/A         |

## Dust Caps

- For use with all Cinch D-subminiature connectors.
- Used to protect connector contacts when connector is not mated.
- Made of polyethylene (black).



## Ordering Information

| Shell Size | Fits Standard Density | Fits Catalog No. | Description | A     |       | B     |       | C    |       | D    |       |
|------------|-----------------------|------------------|-------------|-------|-------|-------|-------|------|-------|------|-------|
|            |                       |                  |             | in    | mm    | in    | mm    | in   | mm    | in   | mm    |
| E          | 9                     | DE-59-20         | Socket      | .694  | 17.63 | .627  | 15.93 | .362 | 9.19  | .295 | 7.49  |
| E          | 9                     | DE-60-20         | Plug        | .749  | 19.02 | .682  | 17.32 | .412 | 10.46 | .345 | 8.76  |
| A          | 15                    | DA-59-20         | Socket      | 1.022 | 25.95 | .955  | 24.25 | .362 | 9.19  | .295 | 7.49  |
| A          | 15                    | DA-60-20         | Plug        | 1.077 | 27.36 | 1.010 | 25.65 | .412 | 10.46 | .345 | 8.76  |
| B          | 25                    | DB-59-20         | Socket      | 1.562 | 39.67 | 1.495 | 37.97 | .362 | 9.19  | .295 | 7.49  |
| B          | 25                    | DB-60-20         | Plug        | 1.635 | 41.52 | 1.568 | 39.83 | .430 | 10.92 | .363 | 9.22  |
| C          | 37                    | DC-59-20         | Socket      | 2.210 | 56.13 | 2.143 | 54.43 | .362 | 9.19  | .295 | 7.49  |
| C          | 37                    | DC-60-20         | Plug        | 2.283 | 57.99 | 2.216 | 56.29 | .430 | 10.92 | .363 | 9.22  |
| D          | 50                    | DD-59-20         | Socket      | 2.116 | 53.75 | 2.049 | 52.04 | .474 | 12.04 | .407 | 10.34 |
| D          | 50                    | DD-60-20         | Plug        | 2.179 | 55.35 | 2.112 | 53.64 | .536 | 13.61 | .469 | 11.91 |

## Guide Pin Plates

- Aligns connectors before actual mating. Generally used in blind mate applications.
- Male or female guide plates will accommodate Cinch male or female connectors.
- Plate: Cold-rolled steel with cadmium plating and yellow chromate finish.
- Guide pin (male): Stainless steel, passivated.
- Screws, rivets (male plate), washers (male plate): Steel with cadmium plating and yellow chromate finish.

### Plug



### Socket



## Ordering Information

| Shell Size | Fits Standard Density | Fits     |          | A     |       | B     |       | C     |        | D    |       | F     |       | G     |       | K     |       |
|------------|-----------------------|----------|----------|-------|-------|-------|-------|-------|--------|------|-------|-------|-------|-------|-------|-------|-------|
|            |                       | Plug     | Socket   | in    | mm    | in    | mm    | in    | mm     | in   | mm    | in    | mm    | in    | mm    | in    | mm    |
| E          | 9                     | N/A      | N/A      |       |       |       |       |       |        |      |       |       |       |       |       |       |       |
| A          | 15                    | DA-22213 | DA-22214 | 2.281 | 57.93 | 1.000 | 25.40 | 1.312 | 33.32  | .750 | 19.05 | .898  | 22.81 | 1.663 | 42.24 | 1.906 | 48.41 |
| B          | 25                    | DB-22255 | DB-22254 | 2.820 | 71.63 | 1.000 | 25.40 | 1.852 | 47.04  | .750 | 19.05 | 1.168 | 29.67 | 2.203 | 55.96 | 2.446 | 62.13 |
| C          | 37                    | DC-22070 | DC-22071 | 3.468 | 88.09 | 1.000 | 25.40 | 2.500 | 63.50  | .750 | 19.05 | 1.492 | 37.90 | 2.851 | 72.42 | 3.094 | 78.59 |
| D          | 50                    | DD-21962 | DD-21961 | 3.375 | 85.73 | 1.125 | 28.58 | 2.406 | 61.112 | .874 | 21.88 | 1.437 | 36.50 | 2.749 | 69.82 | 3.000 | 76.20 |

## Slide Lock Assemblies

- A slide lock assembly is a metal bracket offered with hardware necessary to mount into the standard connector mounting holes. It consists of the lock retainer plate, two screws, two washers, and two nuts. Two lock posts are required to fit into the mounting holes of the mating connector. These must be ordered separately.
- Compatible with all Cinch Backshells, Hoods, and Junction Shells *except* D\*H Series, SDH Series, and phenolic hood.
- Compatible with all Cinch metal shell D-subminiature connectors.

## Materials

- Slide Lock Plate: Stainless steel, passivated.
- Slide lock hex nut, washer #4-40 screw: Steel with zinc plating and yellow chromate finish.
- Lockpost, washer, lockwasher, and hex nut: Steel with zinc plating and yellow chromate finish.



Consists of Lock Retainer and two lock posts (order separately).  
NOTE: Not compatible with D\*H Series or SDH Series backshells.

## Ordering Information

| Shell Size | Fits Standard Density | Lock Retainer | A     |       | B    |       | C     |       |
|------------|-----------------------|---------------|-------|-------|------|-------|-------|-------|
|            |                       |               | in    | mm    | in   | mm    | in    | mm    |
| E          | 9                     | DE-51224-1    | 1.442 | 36.63 | .500 | 12.70 | 0.984 | 24.99 |
| A          | 15                    | DA-51220-1    | 1.770 | 44.96 | .500 | 12.70 | 1.312 | 33.27 |
| B          | 25                    | DB-51221-1    | 2.293 | 58.24 | .500 | 12.70 | 1.852 | 47.04 |
| C          | 37                    | DC-51222-1    | 2.958 | 75.13 | .500 | 12.70 | 2.500 | 63.50 |
| D          | 50                    | DD-51223-1    | 2.847 | 72.31 | .609 | 15.47 | 2.406 | 62.48 |

**Lock Post: #D53018. Two (2) required with each Slide Lock Assembly.**

### Screwlocks

- Screwlocks are designed to retain the same size mated connectors together or to secure the connector to a rack/panel. Screwlocks may be used on plugs or sockets.
- Female screwlocks consist of one #4-40 screw with a #4-40 hole in the top, two flat washers to accommodate different panel thicknesses, one lockwasher, and one #4-40 nut. Military female screwlocks include three flat washers.
- Male screwlocks consist of one #4-40 slotted screw and a spring tension clip. Different sizes accommodate the various connector flange sizes and types of backshells or hoods (if applicable).
- Two screwlocks are required per connector.
- Military screwlocks meet all requirements of MIL-C-24308.

### Materials

#### Commercial Screwlock Assemblies:

- Male Screwlock Assembly: Clip and screw are steel with zinc plating and yellow chromate finish.
- Female Screwlock Assembly: Washers (2), lockwashers, hex nuts, and nuts are steel with zinc plating and yellow chromate finish.

#### M24308 Military Screwlock Assemblies:

- Male Screwlock Assembly: Clip and screw are steel with cadmium plating and yellow chromate finish.
- Female Screwlock Assembly: Washers (3), lockwashers, hex nuts, and nuts are steel with cadmium plating and yellow chromate finish.



Female Screwlock



Male Screwlock



- Screwlock assemblies will not fit D\*H or SDH Series backshells.

## Male Screwlocks

.547 (13.89) SHELL SIZES E, A, B, C  
.656 (16.66) SHELL SIZE D



## Ordering Information

| Shell Size<br>Positions      | A            |       | B     |      | E   | A   | B    | C    | D    |
|------------------------------|--------------|-------|-------|------|-----|-----|------|------|------|
|                              | in           | mm    | in    | mm   | 9   | 15  | 25   | 37   | 50   |
| <b>Commercial:</b>           |              |       |       |      |     |     |      |      |      |
| D20419-0                     | 0.250        | 56.35 | 0.033 | 0.84 | P/S | P/S | S    | S    |      |
| D20419-16                    | 0.250        | 56.35 | 0.048 | 1.22 | S*  | S*  | P/S* | P/S* |      |
| D20419-21                    | 0.281        | 63.34 | 0.059 | 1.50 |     | P*  | P*   |      |      |
| D20420-0                     | 0.250        | 56.35 | 0.033 | 0.84 |     |     |      |      | S    |
| D20420-12                    | 0.281        | 63.34 | 0.048 | 1.22 |     |     |      |      | P/S* |
| D20420-15                    | 0.281        | 63.34 | 0.059 | 1.50 |     |     |      |      | P*   |
| <b>Military MIL-C-24308:</b> |              |       |       |      |     |     |      |      |      |
| M24308/25-9F                 | Per MIL spec |       |       |      | P/S | P/S | P/S  | P/S  |      |
| M24308/25-10F                | Per MIL spec |       |       |      |     |     |      |      | P/S  |

NOTE: P = Plug, S = Socket  
\* Indicates use with junction shell

## Female Screwlocks



## Ordering Information

| Shell Size<br>Positions      | A            |        | E   | A   | B   | C   | D   |
|------------------------------|--------------|--------|-----|-----|-----|-----|-----|
|                              | in           | mm     | 9   | 15  | 25  | 37  | 50  |
| <b>Commercial:</b>           |              |        |     |     |     |     |     |
| D20418-2                     | 0.312        | 70.32  | P/S | P/S | P/S | P/S | P/S |
| D20418-39                    | 0.628        | 141.55 | P/S | P/S | P/S | P/S | P/S |
| <b>Military MIL-C-24308:</b> |              |        |     |     |     |     |     |
| M24308/26-1F                 | Per MIL spec |        | P/S | P/S | P/S | P/S | P/S |
| M24308/26-2F                 | Per MIL spec |        | P/S | P/S | P/S | P/S | P/S |

NOTE: P = Plug, S = Socket

**Auto-Clinch™ D Semi-Automatic Termination Tool**

Auto Clinch D is a semi-automatic, pneumatically powered, and electrically controlled termination machine designed to terminate IDC D-subminiature connectors. It employs a selective programmer and a common nest for all four connector sizes and can be equipped to terminate metal shell connectors. It can also be optionally equipped with remote visual color code display for training sequences. It has a provision for omission of wires.

Part No.: ACD-432

**Auto-Clinch D Tool****Certi-Clinch™ D Field Termination Tool**  
**\*For 24-26 AWG Wire**

Certi-Clinch D is designed for mass termination of individual wires, eliminating wire stripping, soldering, and crimping. It handles all four connector sizes, is readily portable, and requires no set-up time and little operator time. Rugged, all-metal construction affords trouble-free long life.

For metal shell IDC D-subminiature connectors.  
Part No. SD-CCWN

For all-plastic IDC D-subminiature connectors.  
Part No. SD-CC

Conversion nest for converting all-plastic type to metal shell.  
Part No. SD-CCN

**Certi-Clinch D Field Termination Tool****Uni-Clinch™ D Single-Wire Hand Insertion Tool**

Designed to insert one 22-26 AWG wire at a time, Uni-Clinch D is used as a field repair tool by field service engineers.

Part No. SD-UC

**Uni-Clinch Hand Insertion Tool****Super D™ Manual Stay Band Tool**

Designed for applying the steel stay band/strain relief to the cable before termination of wires to the connector, the manual Stay Band Tool applies both stay band sizes to the full range of cable sizes.

Part No. SD-MSBT

**Manual Tool**

NOTE: All termination tools on this page are used in conjunction with T\* Series D-subminiature connectors.

### Hand Crimping Tool for Stamped Contact 300 PC Reels

Two types of transport for connector chains are available with crimping ranges of 20 through 30 AWG for B crimpings

|                        | Part Number |
|------------------------|-------------|
| D*A Series             |             |
| 20 through 26 AWG Wire | GHC-B       |
| D*A Series             |             |
| 28 through 30 AWG Wire | GHC-B1      |
| HTD Series             | HTD-266     |



Contact Crimp Hand Tool (300 Contact Reel)

### Hand Crimping Tool for Loose Stamped Contacts

|            | Part Number |
|------------|-------------|
| D*A Series | HTD-544     |
| D*U Series | BT-20-HC    |
| HTD Series | HTD-544     |



Contact Crimp Hand Tool (HTD-544)

### Contact Insertion/Extraction Tool for Stamped Contacts

|            | Part Number |
|------------|-------------|
| D*A Series | CIET-20-HDB |
| D*U Series | CIET-20-HDB |
| HTD Series | CIET-22-DF  |



Contact Crimp Hand Tool (BT-20-HC)



Contact Insertion/Extraction Hand Tool For D\*A and D\*U Series for Stamped Contacts (CIET-20-HDB)

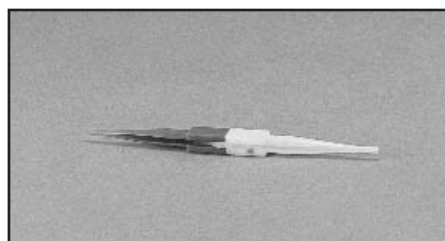

Contact Insertion/Extraction Hand Tool For D1/2 Contacts (CIET-22-DF)

**Semi-Automatic Stripping and Crimping Tool**

**Advantages and Characteristics**

- Stripping and crimping in one easy operation
- Easy to install and adjust
- Requires little maintenance
- Wearing parts replaced in a matter of minutes
- Long service life thanks to best-quality materials
- Different quick change applicators in the same stripper crimper
- Increased productivity



Our GSC-20-30 crimp machine in operation with stripper crimper and quick change tool

**Ordering Information**

**Stripper Crimper**

| Description                                    | Part Number   | Comments  | Catalog Number |
|--|---------------|---|----------------|
| D*A Series<br>Stripper Crimper Only            | 599-11-11-578 | Comes equipped with the applicator for 20-24 AWG contacts | GSC-20-30      |
| D*A Series<br>Applicator Only<br>For 20-24 AWG | 598-98-97-630 | Applicator only<br>For 20-24 AWG contacts                 | ASC-20-24      |
| D*A Series<br>Applicator Only<br>For 26-30 AWG | 598-98-97-632 | Applicator only<br>For 26-30 AWG contacts                 | ASC-26-30      |
| HTD Series<br>Stripper Crimper Only            | 599-11-11-518 | Comes equipped with applicator for 22-28 AWG contacts     | HTD-518        |
| HTD Series<br>Applicator Only<br>22-28 AWG     | 598-98-97-636 | Applicator only<br>For 22-28 AWG contacts                 | ASC-DH         |
| D*U Series<br>Stripper Crimper Only            | 599-11-11-258 | Comes equipped with applicator for 20-28 AWG contacts     | ESC-20-3       |
| D*U Series<br>Applicator Only<br>20-28         | 598-98-97-638 | Applicator only<br>For 20-28 AWG contacts                 | ASC-DU         |

**Stripper Crimper Spare Parts**

| Part Number   | Description                         | Catalog Number |
|---------------|-------------------------------------|----------------|
| 598-98-97-631 | D*A Punch & Anvil Kit 20-24 AWG     | SCPA-631       |
| 598-98-97-633 | D*A Punch & Anvil Kit 26-30 AWG     | SCPA-633       |
| 598-98-97-637 | HTD Series Punch & Anvil Kit        | SCPA-637       |
| 598-98-97-639 | D*U Series Punch & Anvil Kit        | SCPA-639       |
| 598-98-97-640 | Stripping Blades for 20-24 AWG Wire | SCSB-640       |
| 598-98-97-641 | Stripping Blades for 26-30 AWG Wire | SCSB-641       |
| 598-98-97-642 | D*A Series Contact shear blade      | SCCS-642       |
| 598-98-97-643 | Shear blade holder                  | SCSH-643       |
| 598-98-97-644 | Sensor switch                       | SCSS-644       |
| 598-98-97-645 | Strip blade holder                  | SCBH-645       |





M22520/2-01

**Metal Shell High-Reliability Crimp and Poke Termination Tool**

Hand crimping tool for high-reliability machined D\*U, Series 3, and M24308 Crimp and Poke contacts.  
M22520/2-01

NOTE: Positioner required with crimping tool

**Positioner**--A device when attached to a crimping tool that locates the contact in the correct position.

Positioner for machined contacts  
**D\*U Series Positioner**

Part No.: 599-11-11-580  
Catalog No.: EP-580

**Series 3 and M24308 Connector Positioner**  
Part No.: 598-98-97-618  
Catalog No.: M22520/2-08



CIET-20-HD

**Metal Shell Military Crimp and Poke Insertion/Extraction Tool**

For inserting or extracting machined D\*U, Series 3, or M24308 Crimp and Poke contacts.

Part No.: CIET-20-HD



CET-20-11

**Military Extraction Tip Only**

For extracting high-reliability machined D\*U, Series 3, or M24308 Crimp and Poke contacts.

Part No.: CET-20-11



CET-C6B

**Coaxial and High-Voltage Contact Extraction Tool**

For extracting co-axial and high-voltage contacts from metal shell high-reliability connectors.

Part No.: CET-C6B



FCT-551

**Pneumatic Bench Top Press for Crimping Ferrules**

This lightweight, portable press is used to crimp the ferrules on the overmold shielding hardware kits. Crimp dies ordered separately.

Part No.: 599-11-11-551  
Catalog No.: FCT-551



FCT-552

**Hand Tool for Crimping Ferrules and Coax Contacts**

Uses same crimp dies as pneumatic tool.  
Part No.: 599-11-11-552  
Catalog No.: FCT-552

**Crimp Ferrule**



| Catalog Number | Part Number   | Type | Crimp Die Part No. | Crimp Die Catalog No. |
|----------------|---------------|------|--------------------|-----------------------|
| CF-51          | 462-44-22-451 | 1    | 598-98-97-607      | CD-07                 |
| CF-42          | 462-44-22-442 | 1    | 598-98-97-600      | CD-00                 |
| CF-43          | 462-44-22-443 | 1    | 598-98-97-601      | CD-01                 |
| CF-44          | 462-44-22-444 | 1    | 598-98-97-602      | CD-02                 |
| CF-45          | 462-44-22-445 | 1    | 598-98-97-603      | CD-03                 |
| CF-46          | 462-44-22-446 | 1    | 598-98-97-604      | CD-04                 |
| CF-47          | 462-44-22-447 | 2    | 598-98-97-605      | CD-05                 |
| CF-50          | 462-44-22-450 | 2    | 598-98-97-606      | CD-06                 |

# DURA-CON

All-Plastic

Strip Connectors

Metal Shell

Mil-C-83513 Connectors

Terminal Blocks

Microedge

.050" D-microminiature



**Cinch**

Cinch Dura-Con™ connectors are designed for applications that require a rugged, durable, and high-performance interconnect. Dura-Con is the ideal connector for applications where weight and space must be kept to a minimum while maintaining maximum reliability. Miniaturized airborne electronics and data processing equipment, where shorter signal paths are needed, represent typical applications for these unique connectors.

The heart of the Dura-Con system is the Dura-Con pin contact. The Cinch Dura-Con pin contact is made from a precision miniature spring cable with a welded tip. The expanded cable provides seven spring members peripherally around the pin so that contact is maintained with the mating socket wall no matter what radial forces are applied. This spring may be flexed many times without any evidence of metal fatigue. Reliable mating is further ensured by protecting the pin contact in a tightly tolerated recessed cavity.

Cinch's family of Dura-Con connectors includes MIL-C-83513 Series connectors along with our own commercial equivalents. The commercial Dura-Con product line offers an expanded range of termination and hardware options for all-plastic and metal shell wire versions and right-angle and straight PC board mount "terminal blocks". Cinch also packages the Dura-Con contact in a very low profile plastic strip connector on .050" centers and in a line of high-density microminiature edge (Microedge) board connectors that meet the requirements of MIL-C-55302. Cinch has created a line of plastic and metal shell Dura-Con connector savers for very high mating cycle applications such as test equipment.

### Termination Options:

Cinch offers the following termination methods for its Dura-Con connectors:

Insulated Wire - Insulated wire is crimped to the Dura-Con contacts then epoxy backpotted at the factory. Wire is available in standard lengths of 18, 24, 36, and 48 inches.

Uninsulated Wire - 24 AWG, gold-plated, uninsulated wire is crimped to the Dura-Con contact at the factory. Wire is available in standard lengths of 0.5, 1.0, and 2.0 inches. This option allows the user greater flexibility when installing the connector.

Solder Cup - For applications that require the lowest contact resistance, Cinch offers Dura-Con connectors with solder cups for termination by the user.



Dura-Con is a trademark of Cinch Connectors.

**Custom Capabilities:**

Standard Cinch Dura-Con connectors satisfy a wide variety of applications. Cinch's line of Dura-Con D-microminiature connectors is one of the most versatile in the industry. There are over 50,000 possible combinations of Cinch standard options such as connector type, size, materials, hardware, and termination.

When special application requirements arise, Cinch Dura-Con connectors take this versatility to the next level. Whether specific needs entail new variations of simple end-to-end connector assemblies or more complex and intricate harness assemblies, Cinch Connector Division has the state-of-the-art engineering resources and research facilities in place to meet your needs. Cinch approaches your business with a well-defined goal: to ensure the integrity of your design and to execute our contribution to it in a responsible, cost-effective manner. This philosophy has led Cinch to a position of industry leadership.

For complete information regarding the total capabilities of the Dura-Con connector series, or for custom application assistance, contact your nearest Cinch Connectors sales office.



5

**Dura-Con**  
**High Reliability**  
**All-Plastic**

.050" (1.27mm) Density  
 Solder Cup/Wire  
 D-Microminiature



FEATURES

- Both plug and socket available in 9, 15, 21, 25, 31, 37, and 51 positions.
- Termination styles - solder cup, gold-plated solid wire, and insulated stranded wire.
- Several styles of mounting hardware are available for cable-to-cable, cable-to-board mount, and cable-to-panel mount applications.
- High-performance Dura-Con twist-pin contact.
- Economical all-plastic shell for lightweight applications where no shielding is required.
- Meets requirements of MIL-C-83513 except where noted.



MATERIALS

**Insulator:** UL94V-0 rated glass-filled polyester  
**Contacts:** Pins - Copper alloy, Sockets - Copper alloy (machined)  
**Contact Plating:** .000050 in gold

ENVIRONMENTAL

**Operating Temperature:** -55° C to +135° C

ELECTRICAL

**Current Rating:** 3 Amps maximum  
**Withstanding Voltage:** 600 VAC RMS @ sea level  
**Contact Resistance:** 8 milliohms maximum change

MECHANICAL

**Individual Contact:** 6 oz. (170.40 g) maximum insertion;  
 0.5 oz. (14.20 g) minimum withdrawal  
**Mating / Unmating Force:** See table

| No. of Contacts | Maximum Mating Force |       | Minimum Unmating Force |     |
|-----------------|----------------------|-------|------------------------|-----|
|                 | Lb.                  | Kg    | Lb.                    | Kg  |
| 9               | 5.63                 | 2.56  | .28                    | .13 |
| 15              | 9.38                 | 4.26  | .47                    | .21 |
| 21              | 13.13                | 5.96  | .66                    | .30 |
| 25              | 15.63                | 7.10  | .78                    | .35 |
| 31              | 19.38                | 8.80  | .97                    | .44 |
| 37              | 23.13                | 10.50 | 1.16                   | .53 |
| 51              | 31.88                | 14.47 | 1.59                   | .72 |

**Contact Arrangements**  
 (Face view of pin insulator)  
 (Use reverse order for socket)



**Ordering Information**



\* - Indicates Cinch std. option.

\*\* - See p. 5-12 for std. hardware dims. See p. 5-13 for non-std. hardware & p. 5-31 for Mil spec. hardware both sold separately.

\*\*\* - Length Tolerance: solid wire =  $\pm 3/32"$ , standard wire =  $\pm 1/4"$ .

**Connector Dimensions - Plastic Shell**

**Plug**



**Socket**



5

| No. of Contacts | A             |       | B Max. |       | C                            |       | D            |       | E            |      | F Max. |      |
|-----------------|---------------|-------|--------|-------|------------------------------|-------|--------------|-------|--------------|------|--------|------|
|                 | ± .010 (.254) |       |        |       | +.010 (.254)<br>-.018 (.457) |       | ±.005 (.127) |       | ±.010 (.254) |      |        |      |
|                 | in            | mm    | in     | mm    | in                           | mm    | in           | mm    | in           | mm   | in     | mm   |
| 9 Plug          | .778          | 19.76 | .292   | 7.42  | .398                         | 10.11 | .565         | 14.35 | .208         | 5.28 | .173   | 4.39 |
| 9 Socket        | .778          | 19.76 | .376   | 9.55  | .398                         | 10.11 | .565         | 14.35 | .208         | 5.28 | .173   | 4.39 |
| 15 Plug         | .928          | 23.57 | .442   | 11.23 | .548                         | 13.92 | .715         | 18.16 | .208         | 5.28 | .173   | 4.39 |
| 15 Socket       | .928          | 23.57 | .526   | 13.36 | .548                         | 13.92 | .715         | 18.16 | .208         | 5.28 | .173   | 4.39 |
| 21 Plug         | 1.078         | 27.38 | .592   | 15.04 | .698                         | 17.73 | .865         | 21.97 | .208         | 5.28 | .173   | 4.39 |
| 21 Socket       | 1.078         | 27.38 | .676   | 17.17 | .698                         | 17.73 | .865         | 21.97 | .208         | 5.28 | .173   | 4.39 |
| 25 Plug         | 1.178         | 29.92 | .692   | 17.58 | .798                         | 20.27 | .965         | 24.51 | .208         | 5.28 | .173   | 4.39 |
| 25 Socket       | 1.178         | 29.92 | .776   | 19.71 | .798                         | 20.27 | .965         | 24.51 | .208         | 5.28 | .173   | 4.39 |
| 31 Plug         | 1.328         | 33.73 | .842   | 21.39 | .948                         | 24.08 | 1.115        | 28.32 | .208         | 5.28 | .173   | 4.39 |
| 31 Socket       | 1.328         | 33.73 | .926   | 23.52 | .948                         | 24.08 | 1.115        | 28.32 | .208         | 5.28 | .173   | 4.39 |
| 37 Plug         | 1.478         | 37.54 | .992   | 25.20 | 1.098                        | 27.89 | 1.265*       | 32.13 | .208         | 5.28 | .173   | 4.39 |
| 37 Socket       | 1.478         | 37.54 | 1.076  | 27.33 | 1.098                        | 27.89 | 1.265*       | 32.13 | .208         | 5.28 | .173   | 4.39 |
| 51 Plug         | 1.428         | 36.27 | .942   | 23.93 | 1.048                        | 26.62 | 1.215        | 30.86 | .250         | 6.35 | .220   | 5.59 |
| 51 Socket       | 1.428         | 36.27 | 1.026  | 26.06 | 1.048                        | 26.62 | 1.215        | 30.86 | .250         | 6.35 | .220   | 5.59 |

**Panel Mounting Dimensions**

Pin and socket,  
rear mounted



Pin and socket,  
front mounted



Pin, front mounted  
Socket, rear mounted



**Panel Cutout Dimensions**



Figure 1. Front Mounting



Figure 2. Rear Mounting



Figure 3. Edgeboard Mounting

| No. of Contacts | Figure Number | A                      |                        | B                      |                        | C                      |                        |
|-----------------|---------------|------------------------|------------------------|------------------------|------------------------|------------------------|------------------------|
|                 |               | +0.004<br>-0.000<br>in | (.101)<br>(.000)<br>mm | +0.004<br>-0.000<br>in | (.101)<br>(.000)<br>mm | +0.005<br>-0.000<br>in | (.127)<br>(.000)<br>mm |
| 9               | 1             | .408                   | 10.36                  | .172                   | 4.37                   | .570                   | 14.48                  |
|                 | 2             | .373                   | 9.47                   | .216                   | 5.49                   | .570                   | 14.48                  |
|                 | 3             | -                      | -                      | -                      | -                      | .570                   | 14.48                  |
| 15              | 1             | .558                   | 14.17                  | .172                   | 4.37                   | .720                   | 18.29                  |
|                 | 2             | .523                   | 13.28                  | .216                   | 5.49                   | .720                   | 18.29                  |
|                 | 3             | -                      | -                      | -                      | -                      | .720                   | 18.29                  |
| 21              | 1             | .708                   | 17.98                  | .172                   | 4.37                   | .870                   | 22.10                  |
|                 | 2             | .674                   | 17.12                  | .216                   | 5.49                   | .870                   | 22.10                  |
|                 | 3             | -                      | -                      | -                      | -                      | .870                   | 22.10                  |
| 25              | 1             | .808                   | 20.52                  | .172                   | 4.37                   | .970                   | 24.64                  |
|                 | 2             | .774                   | 19.66                  | .216                   | 5.49                   | .970                   | 24.64                  |
|                 | 3             | -                      | -                      | -                      | -                      | .970                   | 24.64                  |
| 31              | 1             | .958                   | 24.33                  | .172                   | 4.37                   | 1.120                  | 28.45                  |
|                 | 2             | .924                   | 23.47                  | .216                   | 5.49                   | 1.120                  | 28.45                  |
|                 | 3             | -                      | -                      | -                      | -                      | 1.120                  | 28.45                  |
| 37              | 1             | 1.108                  | 28.14                  | .172                   | 4.37                   | 1.270                  | 32.26                  |
|                 | 2             | 1.074                  | 27.28                  | .216                   | 5.49                   | 1.270                  | 32.26                  |
|                 | 3             | -                      | -                      | -                      | -                      | 1.270                  | 32.26                  |
| 51              | 1             | 1.058                  | 26.87                  | .215                   | 5.46                   | 1.220                  | 30.99                  |
|                 | 2             | 1.024                  | 26.01                  | .259                   | 6.58                   | 1.220                  | 30.99                  |
|                 | 3             | -                      | -                      | -                      | -                      | 1.220                  | 30.99                  |



**Dura-Con**  
**High Reliability**  
**Metal Shell**

.050" (1.27mm) Density  
 Solder Cup/Wire  
 D-Microminiature



FEATURES

- Both plug and socket available in 9, 15, 21, 25, 31, 37, 51, and 100 positions.
- Several styles of mounting are available for cable-to-cable, cable-to-panel mount, and cable-to-board mount.
- Aluminum shell provides extra strength and EMI/RFI shielding capability. Plating options available.
- Silicone elastomer compression interfacial seal protects contacts from moisture and humidity and isolates contacts from each other and the metal shell.
- Meets requirements of MIL-C-83513 except where noted.
- Rugged twist-pin contacts resistant to shock and vibration make metal shell Dura-Con an excellent choice for harsh environments such as airborne or space applications.



MATERIALS

**Insulator:** UL94V-0 rated glass-filled polyester or diallyl phthalate  
**Contacts:** Pins - Copper alloy, Sockets - Copper alloy (machined)  
**Contact Plating:** .000050 in gold  
**Shell:** Aluminum alloy  
**Shell Plating:** Yellow chromate over cadmium (std.) or electroless nickel

ENVIRONMENTAL

**Operating Temperature:** -55°C to +135°C

ELECTRICAL

**Current Rating:** 3 Amps maximum  
**Withstanding Voltage:** 600 VAC RMS @ sea level  
**Contact Resistance:** 8 milliohms maximum

MECHANICAL

**Individual Contact:** 6 oz. (170.40 g) maximum insertion;  
 0.5 oz. (14.20 g) minimum withdrawal  
**Mating / Unmating Force:** See table

| No. of Contacts | Maximum Mating Force |       | Minimum Unmating Force |      |
|-----------------|----------------------|-------|------------------------|------|
|                 | Lb.                  | Kg    | Lb.                    | Kg   |
| 9               | 5.63                 | 2.56  | .28                    | .13  |
| 15              | 9.38                 | 4.26  | .47                    | .21  |
| 21              | 13.13                | 5.96  | .66                    | .30  |
| 25              | 15.63                | 7.10  | .78                    | .35  |
| 31              | 19.38                | 8.80  | .97                    | .44  |
| 37              | 23.13                | 10.50 | 1.16                   | .53  |
| 51              | 31.88                | 14.47 | 1.59                   | .72  |
| 100             | 62.50                | 28.38 | 3.13                   | 1.42 |

**Contact Arrangements**

(Face view of pin insert)  
 (Use reverse order for socket side)



**Ordering Information**



\* - Indicates Cinch std. option.

\*\* - See p. 5-12 for std. hardware dims. See p. 5-13 for non-std. hardware & p. 5-31 for Mil spec. hardware both sold separately.

\*\*\* - Length Tolerance: solid wire = ± 3/32", standard wire = ± 1/4".

**Connector Dimensions - Metal Shell**



| No. of Contacts | A             |       | B Max. |       | C                              |       | D             |       | E             |      | F Max. |      |
|-----------------|---------------|-------|--------|-------|--------------------------------|-------|---------------|-------|---------------|------|--------|------|
|                 | ± .010 (.254) |       |        |       | + .010 (.254)<br>- .018 (.457) |       | ± .005 (.127) |       | ± .010 (.254) |      |        |      |
|                 | in            | mm    | in     | mm    | in                             | mm    | in            | mm    | in            | mm   | in     | mm   |
| 9 Plug          | .775          | 19.68 | .333   | 8.46  | .390                           | 9.91  | .565          | 14.35 | .298          | 7.57 | .270   | 6.86 |
| 9 Socket        | .775          | 19.68 | .396   | 10.06 | .390                           | 9.91  | .565          | 14.35 | .298          | 7.57 | .270   | 6.86 |
| 15 Plug         | .925          | 23.50 | .483   | 12.27 | .540                           | 13.72 | .715          | 18.16 | .298          | 7.57 | .270   | 6.86 |
| 15 Socket       | .925          | 23.50 | .546   | 13.87 | .540                           | 13.72 | .715          | 18.16 | .298          | 7.57 | .270   | 6.86 |
| 21 Plug         | 1.075         | 27.30 | .633   | 16.08 | .690                           | 17.53 | .865          | 21.97 | .298          | 7.57 | .270   | 6.86 |
| 21 Socket       | 1.075         | 27.30 | .696   | 17.68 | .690                           | 17.53 | .865          | 21.97 | .298          | 7.57 | .270   | 6.86 |
| 25 Plug         | 1.175         | 29.84 | .733   | 18.62 | .790                           | 20.07 | .965          | 24.51 | .298          | 7.57 | .270   | 6.86 |
| 25 Socket       | 1.175         | 29.84 | .796   | 20.22 | .790                           | 20.07 | .965          | 24.51 | .298          | 7.57 | .270   | 6.86 |
| 31 Plug         | 1.325         | 33.66 | .883   | 21.16 | .940                           | 23.88 | 1.115         | 28.32 | .298          | 7.57 | .270   | 6.86 |
| 31 Socket       | 1.325         | 33.66 | .946   | 24.03 | .940                           | 23.88 | 1.115         | 28.32 | .298          | 7.57 | .270   | 6.86 |
| 37 Plug         | 1.475         | 37.46 | 1.033  | 26.24 | 1.090                          | 27.69 | 1.265         | 32.13 | .298          | 7.57 | .270   | 6.86 |
| 37 Socket       | 1.475         | 37.46 | 1.096  | 27.84 | 1.090                          | 27.69 | 1.265         | 32.13 | .298          | 7.57 | .270   | 6.86 |
| 51 Plug         | 1.425         | 36.20 | .983   | 24.97 | 1.040                          | 26.42 | 1.215         | 30.86 | .341          | 8.66 | .310   | 7.87 |
| 51 Socket       | 1.425         | 36.20 | 1.046  | 26.57 | 1.040                          | 26.42 | 1.215         | 30.86 | .341          | 8.66 | .310   | 7.87 |
| 100 Plug        | 2.160         | 54.86 | 1.383  | 35.13 | 1.432                          | 36.38 | 1.800         | 45.71 | .384          | 9.75 | .360   | 9.15 |
| 100 Socket      | 2.160         | 54.86 | 1.446  | 36.73 | 1.432                          | 36.38 | 1.800         | 45.71 | .384          | 9.75 | .360   | 9.15 |

**Panel Mounting Dimensions**

Pin and socket,  
rear mounted



Pin and socket,  
front mounted



Pin, front mounted  
Socket, rear mounted



**Panel Cutout Dimensions**



| No. of Contacts | Figure Number | A                      |                        | B                      |                        | C                      |                        | D                      |                        |
|-----------------|---------------|------------------------|------------------------|------------------------|------------------------|------------------------|------------------------|------------------------|------------------------|
|                 |               | +0.004<br>-0.000<br>in | (.101)<br>(.000)<br>mm | +0.004<br>-0.000<br>in | (.101)<br>(.000)<br>mm | +0.005<br>-0.000<br>in | (.127)<br>(.000)<br>mm | +0.005<br>-0.000<br>in | (1.27)<br>(.000)<br>mm |
| 9               | 1             | .408                   | 10.36                  | .270                   | 6.86                   | .570                   | 14.48                  | -                      | -                      |
|                 | 2             | .408                   | 10.36                  | .256                   | 6.50                   | .570                   | 14.48                  | .089                   | 2.26                   |
|                 | 3             | -                      | -                      | -                      | -                      | .570                   | 14.48                  | -                      | -                      |
| 15              | 1             | .558                   | 14.17                  | .270                   | 6.86                   | .720                   | 18.29                  | -                      | -                      |
|                 | 2             | .558                   | 14.17                  | .256                   | 6.50                   | .720                   | 18.29                  | .089                   | 2.26                   |
|                 | 3             | -                      | -                      | -                      | -                      | .720                   | 18.29                  | -                      | -                      |
| 21              | 1             | .708                   | 17.98                  | .270                   | 6.86                   | .870                   | 22.10                  | -                      | -                      |
|                 | 2             | .708                   | 17.98                  | .256                   | 6.50                   | .870                   | 22.10                  | .089                   | 2.26                   |
|                 | 3             | -                      | -                      | -                      | -                      | .870                   | 22.10                  | -                      | -                      |
| 25              | 1             | .808                   | 20.52                  | .270                   | 6.86                   | .970                   | 24.64                  | -                      | -                      |
|                 | 2             | .808                   | 20.52                  | .256                   | 6.50                   | .970                   | 24.64                  | .089                   | 2.26                   |
|                 | 3             | -                      | -                      | -                      | -                      | .970                   | 24.64                  | -                      | -                      |
| 31              | 1             | .958                   | 24.33                  | .270                   | 6.86                   | 1.120                  | 28.45                  | -                      | -                      |
|                 | 2             | .958                   | 24.33                  | .256                   | 6.50                   | 1.120                  | 28.45                  | .089                   | 2.26                   |
|                 | 3             | -                      | -                      | -                      | -                      | 1.120                  | 28.45                  | -                      | -                      |
| 37              | 1             | 1.108                  | 28.14                  | .270                   | 6.86                   | 1.270                  | 32.26                  | -                      | -                      |
|                 | 2             | 1.108                  | 28.14                  | .256                   | 6.50                   | 1.270                  | 32.26                  | .089                   | 2.26                   |
|                 | 3             | -                      | -                      | -                      | -                      | 1.270                  | 32.26                  | -                      | -                      |
| 51              | 1             | 1.058                  | 26.87                  | .315                   | 8.00                   | 1.220                  | 30.99                  | -                      | -                      |
|                 | 2             | 1.058                  | 26.87                  | .300                   | 7.62                   | 1.220                  | 30.99                  | .089                   | 2.26                   |
|                 | 3             | -                      | -                      | -                      | -                      | 1.220                  | 30.99                  | -                      | -                      |
| 100             | 1             | 1.450                  | 36.84                  | .361                   | 9.17                   | 1.805                  | 45.86                  | .117                   | 2.97                   |
|                 | 2             | 1.562                  | 39.68                  | .338                   | 8.58                   | 1.805                  | 45.86                  | .117                   | 2.97                   |
|                 | 3             | -                      | -                      | -                      | -                      | 1.805                  | 45.86                  | .117                   | 2.97                   |

**Mounting Hardware**  
**For Plastic & Metal Shell**  
**Dura-Con Connectors**



**Float Mounting**  
**Option "F"**



**Reversed Float Mounting**  
**Option "R"**



**Standard Jackscrew**  
**Option "K"**



**Low Profile Jackscrew**  
**Option "L"**



**Removable Jackpost**  
**Option "P"**



Screwlock Kit

**P/N: DCSL1**  
**Purchased Separately**

**Jackpost - Rear Panel Mount**  
 (Purchased Separately)



Jackpost Bushing  
 (for rear panel mounting)

| Jackpost Part Number | Panel Thickness |     | A Dimension |           |
|----------------------|-----------------|-----|-------------|-----------|
|                      | in              | mm  | in          | mm        |
| DCJPRM094            | .094            | 2.5 | .092/.087   | 2.34/2.21 |
| DCJPRM063            | .063            | 1.6 | .061/.056   | 1.55/1.42 |
| DCJPRM047            | .047            | 1.2 | .047/.042   | 1.19/1.07 |
| DCJPRM031            | .031            | 0.8 | .030/.025   | 0.76/0.64 |

**Panel Cutout Dimensions**  
 (Plug & Receptacle)



| Part Number<br>(by Shell Size) | A                            |       | B                            |      | C            |       |
|--------------------------------|------------------------------|-------|------------------------------|------|--------------|-------|
|                                | +.004 (.101)<br>-.000 (.000) |       | +.004 (.101)<br>-.000 (.000) |      | ±.005 (.127) |       |
|                                | in                           | mm    | in                           | mm   | in           | mm    |
| 9                              | .398                         | 10.11 | .249                         | 6.32 | .565         | 14.35 |
| 15                             | .548                         | 13.92 | .249                         | 6.32 | .715         | 18.16 |
| 21                             | .698                         | 17.73 | .249                         | 6.32 | .865         | 21.97 |
| 25                             | .798                         | 20.27 | .249                         | 6.32 | .965         | 24.51 |
| 31                             | .948                         | 24.08 | .249                         | 6.32 | 1.115        | 28.34 |
| 37                             | 1.098                        | 27.89 | .249                         | 6.32 | 1.265        | 32.13 |
| 51                             | 1.048                        | 26.62 | .292                         | 7.42 | 1.215        | 30.86 |
| 100                            | 1.448                        | 36.78 | .336                         | 8.53 | 1.800        | 45.72 |

# Dura-Con High Reliability Metal Shell

.050" (1.27mm) Density  
PCB Mount Terminal Block



## FEATURES

- Plug & socket versions available in 9, 15, 21, 25, 31, 37, 51, and 100 positions.
- Flow-through design facilitates inspection and cleaning after soldering.
- All terminal block connectors use standard mounting hardware.
- Metal shell provides EMI/RFI shielding capability.
- Available in 3 styles: Straight mount, 90° right-angle mount, and 90° right-angle narrow profile mounting.
- Silicone elastomer interfacial seal protects contacts from moisture and isolates them from each other and from the metal shell.
- Meets requirements of MIL-C-83513.
- Choice of insulator materials.



## MATERIALS

**Insulator:** UL94V-0 glass-filled polyester or diallyl phthalate  
**Contacts:** Pins - Copper alloy, Sockets - Copper alloy (machined)  
**Contact Plating:** .000050 in gold  
**Shell:** Aluminum alloy  
**Shell Plating:** Yellow chromate over cadmium (std.) or electroless nickel

## ENVIRONMENTAL

**Operating Temperature:** -55°C to +135°C

## ELECTRICAL

**Current Rating:** 3 Amps maximum  
**Withstanding Voltage:** 600 VAC RMS @ sea level, 150 VAC @ 70,000 ft.  
**Contact Resistance:** 8 milliohms maximum  
**Insulation Resistance:** 1,000 megohms min between adjacent pins

## MECHANICAL

**Individual Contact:** 6 oz. (170.40 g) maximum insertion force;  
 0.5 oz. (14.20 g) minimum withdrawal force  
**Mating / Unmating Forces:** See table

| No. of Contacts | Maximum Mating Force |       | Minimum Unmating Force |      |
|-----------------|----------------------|-------|------------------------|------|
|                 | Lb.                  | Kg    | Lb.                    | Kg   |
| 9               | 5.63                 | 2.56  | .28                    | .13  |
| 15              | 9.38                 | 4.26  | .47                    | .21  |
| 21              | 13.13                | 5.96  | .66                    | .30  |
| 25              | 15.63                | 7.10  | .78                    | .35  |
| 31              | 19.38                | 8.80  | .97                    | .44  |
| 37              | 23.13                | 10.50 | 1.16                   | .53  |
| 51              | 31.88                | 14.47 | 1.59                   | .72  |
| 100             | 62.50                | 28.38 | 3.13                   | 1.42 |

**Contact Arrangements**



**Ordering Information**



\* For other options consult factory.



**90° Termination**



**Recommended Board Layout**



NOTE: For additional connector dimensions, see page 5-10.

| No. of Contacts | A     |       | B     |       | C     |       | F    |       |
|-----------------|-------|-------|-------|-------|-------|-------|------|-------|
|                 | in    | mm    | in    | mm    | in    | mm    | in   | mm    |
| 9 Plug          | 1.390 | 35.31 | 1.150 | 29.21 | .565  | 14.35 | .465 | 11.81 |
| 9 Socket        | 1.390 | 35.31 | 1.150 | 29.21 | .565  | 14.35 | .465 | 11.81 |
| 15 Plug         | 1.540 | 39.12 | 1.300 | 33.02 | .715  | 18.16 | .465 | 11.81 |
| 15 Socket       | 1.540 | 39.12 | 1.300 | 33.02 | .715  | 18.16 | .465 | 11.81 |
| 21 Plug         | 1.690 | 42.93 | 1.450 | 36.83 | .865  | 21.97 | .465 | 11.81 |
| 21 Socket       | 1.690 | 42.93 | 1.450 | 36.83 | .865  | 21.97 | .465 | 11.81 |
| 25 Plug         | 1.790 | 45.47 | 1.550 | 39.37 | .965  | 24.51 | .465 | 11.81 |
| 25 Socket       | 1.790 | 45.47 | 1.550 | 39.37 | .965  | 24.51 | .465 | 11.81 |
| 31 Plug         | 2.040 | 51.82 | 1.800 | 45.72 | 1.115 | 28.32 | .465 | 11.81 |
| 31 Socket       | 2.040 | 51.82 | 1.800 | 45.72 | 1.115 | 28.32 | .465 | 11.81 |
| 37 Plug         | 2.340 | 59.44 | 2.100 | 53.34 | 1.265 | 32.13 | .465 | 11.81 |
| 37 Socket       | 2.340 | 59.44 | 2.100 | 53.34 | 1.265 | 32.13 | .465 | 11.81 |
| 51 Plug         | 1.875 | 47.63 | 1.600 | 40.64 | 1.215 | 30.86 | .565 | 14.35 |
| 51 Socket       | 1.875 | 47.63 | 1.600 | 40.64 | 1.215 | 30.86 | .565 | 14.35 |
| 100 Plug        | 2.780 | 70.61 | 2.500 | 63.50 | 1.800 | 45.72 | .765 | 19.43 |
| 100 Socket      | 2.780 | 70.61 | 2.500 | 63.50 | 1.800 | 45.72 | .765 | 19.43 |

| No. of Contacts | G    |       | H    |      | J    |      | K    |      |
|-----------------|------|-------|------|------|------|------|------|------|
|                 | in   | mm    | in   | mm   | in   | mm   | in   | mm   |
| 9 Plug          | .308 | 7.82  | .190 | 4.83 | .096 | 2.44 | .125 | 3.18 |
| 9 Socket        | .308 | 7.82  | .200 | 5.08 | .096 | 2.44 | .125 | 3.18 |
| 15 Plug         | .308 | 7.82  | .190 | 4.83 | .096 | 2.44 | .125 | 3.18 |
| 15 Socket       | .308 | 7.82  | .200 | 5.08 | .096 | 2.44 | .125 | 3.18 |
| 21 Plug         | .308 | 7.82  | .190 | 4.83 | .096 | 2.44 | .125 | 3.18 |
| 21 Socket       | .308 | 7.82  | .200 | 5.08 | .096 | 2.44 | .125 | 3.18 |
| 25 Plug         | .308 | 7.82  | .190 | 4.83 | .096 | 2.44 | .125 | 3.18 |
| 25 Socket       | .308 | 7.82  | .200 | 5.08 | .096 | 2.44 | .125 | 3.18 |
| 31 Plug         | .308 | 7.82  | .190 | 4.83 | .096 | 2.44 | .125 | 3.18 |
| 31 Socket       | .308 | 7.82  | .200 | 5.08 | .096 | 2.44 | .125 | 3.18 |
| 37 Plug         | .308 | 7.82  | .190 | 4.83 | .096 | 2.44 | .125 | 3.18 |
| 37 Socket       | .308 | 7.82  | .200 | 5.08 | .096 | 2.44 | .125 | 3.18 |
| 51 Plug         | .351 | 8.92  | .190 | 4.83 | .096 | 2.44 | .125 | 3.18 |
| 51 Socket       | .351 | 8.92  | .200 | 5.08 | .096 | 2.44 | .125 | 3.18 |
| 100 Plug        | .394 | 10.00 | .190 | 4.83 | .125 | 3.18 | .225 | 5.72 |
| 100 Socket      | .394 | 10.00 | .200 | 5.08 | .125 | 3.18 | .225 | 5.72 |

# Dura-Con High Reliability Metal Shell

.050" (1.27mm) Density  
PCB Mount Terminal Block



## Straight (180°) Termination



## Recommended Board Layout

(As Viewed from Bottom  
of Terminal Block)



NOTE: For additional connector dimensions, see page 5-10.

| No. of<br>Contacts | A<br>Max. |       | B<br>± .007 (0.18) |       | C<br>± .005 (0.13) |       | D<br>Max. |       | G<br>Max. |       |
|--------------------|-----------|-------|--------------------|-------|--------------------|-------|-----------|-------|-----------|-------|
|                    | in        | mm    | in                 | mm    | in                 | mm    | in        | mm    | in        | mm    |
| 9 Plug             | 1.390     | 35.31 | 1.150              | 29.21 | .565               | 14.35 | .885      | 22.48 | .308      | 7.75  |
| 9 Socket           | 1.390     | 35.31 | 1.150              | 29.21 | .565               | 14.35 | .885      | 22.48 | .308      | 7.75  |
| 15 Plug            | 1.390     | 35.31 | 1.150              | 29.21 | .715               | 18.16 | .945      | 24.0  | .308      | 7.75  |
| 15 Socket          | 1.390     | 35.31 | 1.150              | 29.21 | .715               | 18.16 | .945      | 24.0  | .308      | 7.75  |
| 21 Plug            | 1.690     | 42.93 | 1.450              | 36.83 | .865               | 21.97 | 1.185     | 30.09 | .308      | 7.75  |
| 21 Socket          | 1.690     | 42.93 | 1.450              | 36.83 | .865               | 21.97 | 1.185     | 30.09 | .308      | 7.75  |
| 25 Plug            | 1.740     | 44.20 | 1.500              | 38.10 | .965               | 24.51 | 1.275     | 32.38 | .308      | 7.75  |
| 25 Socket          | 1.740     | 44.20 | 1.500              | 38.10 | .965               | 24.51 | 1.275     | 32.38 | .308      | 7.75  |
| 31 Plug            | 2.040     | 51.82 | 1.800              | 45.72 | 1.115              | 28.32 | 1.575     | 40.00 | .308      | 7.75  |
| 31 Socket          | 2.040     | 51.82 | 1.800              | 45.72 | 1.115              | 28.32 | 1.575     | 40.00 | .308      | 7.75  |
| 37 Plug            | 2.340     | 59.44 | 2.100              | 53.34 | 1.265              | 32.13 | 1.875     | 47.62 | .308      | 7.75  |
| 37 Socket          | 2.340     | 59.44 | 2.100              | 53.34 | 1.265              | 32.13 | 1.875     | 47.62 | .308      | 7.75  |
| 51 Plug            | 2.270     | 57.66 | 2.000              | 50.80 | 1.215              | 30.86 | 1.775     | 45.08 | .351      | 8.92  |
| 51 Socket          | 2.270     | 57.66 | 2.000              | 50.80 | 1.215              | 30.86 | 1.775     | 45.08 | .351      | 8.92  |
| 100 Plug           | 3.070     | 77.98 | 2.800              | 71.12 | 1.800              | 45.72 | 2.585     | 65.55 | .455      | 11.56 |
| 100 Socket         | 3.070     | 77.98 | 2.800              | 71.12 | 1.800              | 45.72 | 2.585     | 65.55 | .455      | 11.56 |

| No. of<br>Contacts | H<br>Max. |      | J<br>± .005 (0.13) |      | K<br>Max. |      | L<br>Max. |       |
|--------------------|-----------|------|--------------------|------|-----------|------|-----------|-------|
|                    | in        | mm   | in                 | mm   | in        | mm   | in        | mm    |
| 9 Plug             | .190      | 4.83 | .096               | 2.44 | .165      | 4.19 | .355      | 9.02  |
| 9 Socket           | .200      | 5.08 | .096               | 2.44 | .165      | 4.19 | .355      | 9.02  |
| 15 Plug            | .190      | 4.83 | .096               | 2.44 | .165      | 4.19 | .355      | 9.02  |
| 15 Socket          | .200      | 5.08 | .096               | 2.44 | .165      | 4.19 | .355      | 9.02  |
| 21 Plug            | .190      | 4.83 | .096               | 2.44 | .165      | 4.19 | .355      | 9.02  |
| 21 Socket          | .200      | 5.08 | .096               | 2.44 | .165      | 4.19 | .355      | 9.02  |
| 25 Plug            | .190      | 4.83 | .096               | 2.44 | .165      | 4.19 | .355      | 9.02  |
| 25 Socket          | .200      | 5.08 | .096               | 2.44 | .165      | 4.19 | .355      | 9.02  |
| 31 Plug            | .190      | 4.83 | .096               | 2.44 | .165      | 4.19 | .355      | 9.02  |
| 31 Socket          | .200      | 5.08 | .096               | 2.44 | .165      | 4.19 | .355      | 9.02  |
| 37 Plug            | .190      | 4.83 | .096               | 2.44 | .165      | 4.19 | .355      | 9.02  |
| 37 Socket          | .200      | 5.08 | .096               | 2.44 | .165      | 4.19 | .355      | 9.02  |
| 51 Plug            | .190      | 4.83 | .096               | 2.44 | .165      | 4.19 | .355      | 9.02  |
| 51 Socket          | .200      | 5.08 | .096               | 2.44 | .165      | 4.19 | .355      | 9.02  |
| 100 Plug           | .190      | 4.83 | .125               | 3.18 | .300      | 7.62 | .550      | 13.97 |
| 100 Socket         | .200      | 5.08 | .125               | 3.18 | .300      | 7.62 | .550      | 13.97 |

**90° Narrow Termination**



**Recommended Board Layout**



(As Viewed from Bottom of Terminal Block)

NOTE: For additional connector dimensions, see page 5-10.

Typ. Hole Dia. = .040" (1.02 mm)

| No. of Contacts | A     |       | B     |       | C    |       |
|-----------------|-------|-------|-------|-------|------|-------|
|                 | in    | mm    | in    | mm    | in   | mm    |
| 9 Plug          | .785  | 19.94 | .565  | 14.35 | .308 | 7.82  |
| 9 Socket        | .785  | 19.94 | .565  | 14.35 | .308 | 7.82  |
| 15 Plug         | .935  | 23.75 | .715  | 18.16 | .308 | 7.82  |
| 15 Socket       | .935  | 23.75 | .715  | 18.16 | .308 | 7.82  |
| 21 Plug         | 1.085 | 27.56 | .865  | 21.97 | .308 | 7.82  |
| 21 Socket       | 1.085 | 27.56 | .865  | 21.97 | .308 | 7.82  |
| 25 Plug         | 1.085 | 30.10 | .965  | 24.51 | .308 | 7.82  |
| 25 Socket       | 1.185 | 30.10 | .965  | 24.51 | .308 | 7.82  |
| 31 Plug         | 1.335 | 33.91 | 1.115 | 28.32 | .308 | 7.82  |
| 31 Socket       | 1.335 | 33.91 | 1.115 | 28.32 | .308 | 7.82  |
| 37 Plug         | 1.485 | 37.72 | 1.265 | 32.13 | .308 | 7.82  |
| 37 Socket       | 1.485 | 37.72 | 1.265 | 32.13 | .308 | 7.82  |
| 51 Plug         | 1.435 | 36.45 | 1.215 | 30.86 | .351 | 8.92  |
| 51 Socket       | 1.435 | 36.45 | 1.215 | 30.86 | .351 | 8.92  |
| 100 Plug        | 2.175 | 55.25 | 1.800 | 45.72 | .394 | 10.00 |
| 100 Socket      | 2.175 | 55.25 | 1.800 | 45.72 | .394 | 10.00 |

| No. of Contacts | F    |      | G    |       | H     |       | J    |      |
|-----------------|------|------|------|-------|-------|-------|------|------|
|                 | in   | mm   | in   | mm    | in    | mm    | in   | mm   |
| 9 Plug          | .230 | 5.84 | .250 | 6.35  | .420  | 10.67 | .096 | 2.44 |
| 9 Socket        | .230 | 5.84 | .250 | 6.35  | .420  | 10.67 | .096 | 2.44 |
| 15 Plug         | .130 | 3.30 | .250 | 6.35  | .420  | 10.67 | .096 | 2.44 |
| 15 Socket       | .130 | 3.30 | .250 | 6.35  | .420  | 10.67 | .096 | 2.44 |
| 21 Plug         | .130 | 3.30 | .250 | 6.35  | .420  | 10.67 | .096 | 2.44 |
| 21 Socket       | .130 | 3.30 | .250 | 6.35  | .420  | 10.67 | .096 | 2.44 |
| 25 Plug         | .130 | 3.30 | .250 | 6.35  | .420  | 10.67 | .096 | 2.44 |
| 25 Socket       | .130 | 3.30 | .250 | 6.35  | .420  | 10.67 | .096 | 2.44 |
| 31 Plug         | .130 | 3.30 | .250 | 6.35  | .520  | 13.21 | .096 | 2.44 |
| 31 Socket       | .130 | 3.30 | .250 | 6.35  | .520  | 13.21 | .096 | 2.44 |
| 37 Plug         | .130 | 3.30 | .250 | 6.35  | .520  | 13.21 | .096 | 2.44 |
| 37 Socket       | .130 | 3.30 | .250 | 6.35  | .520  | 13.21 | .096 | 2.44 |
| 51 Plug         | .150 | 3.81 | .300 | 7.62  | .650  | 16.51 | .096 | 2.44 |
| 51 Socket       | .150 | 3.81 | .300 | 7.62  | .650  | 16.51 | .096 | 2.44 |
| 100 Plug        | .200 | 5.08 | .400 | 10.16 | 1.000 | 25.40 | .125 | 3.18 |
| 100 Socket      | .200 | 5.08 | .400 | 10.16 | 1.000 | 25.40 | .125 | 3.18 |

**Dura-Con**  
**High Reliability**  
**MIL-C-83513**

.050" (1.27mm) Density  
 Solder Cup/Wire  
 D-Microminiature



FEATURES

- All-plastic and metal shell wire versions available in solder cup, gold-plated solid wire, and insulated stranded wire.
- PCB mount "terminal block" type connectors available in straight or right angle.
- Sizes offered - 9, 15, 21, 25, 31, 35, 51, and 100 (metal shell only).
- All products are qualified to the requirements of MIL-C-83513 and marked with the M83513 part number.
- Optional shell platings and insulator materials offer high performance in harsh environments.
- Mounting hardware per MIL-C-83513.



MATERIALS

**Insulator:** UL94V-0 rated glass-filled polyester per MIL-M-24519 or diallyl phthalate (DAP) per MIL-M-14.  
**Contacts:** Pins - Copper alloy, Sockets - Copper alloy  
**Contact Plating:** .000050 in gold per MIL-G-45204  
**Shell Material (Metal Shell Only):** Aluminum alloy  
**Shell Plating (Metal Shell Only):** Yellow chromate over cadmium (std.) or electroless nickel

ENVIRONMENTAL

**Operating Temperature:** -55°C to +125°C

ELECTRICAL

**Current Rating:** 3 Amps maximum  
**Withstanding Voltage:** 600 VAC RMS @ sea level  
**Contact Resistance:** 8 milliohms maximum

MECHANICAL

**Durability:** 500 mate/unmate cycles  
**Individual Contact:** Forces 6 oz. (170.40 g) maximum insertion;  
 0.5 oz. (14.20 g) minimum withdrawal  
**Mating / Unmating Force:** See table

| No. of Contacts | Maximum Mating Force |       | Minimum Unmating Force |     |
|-----------------|----------------------|-------|------------------------|-----|
|                 | Lb.                  | Kg    | Lb.                    | Kg  |
| 9               | 5.63                 | 2.56  | .28                    | .13 |
| 15              | 9.38                 | 4.26  | .47                    | .21 |
| 21              | 13.13                | 5.96  | .66                    | .30 |
| 25              | 15.63                | 7.10  | .78                    | .35 |
| 31              | 19.38                | 8.80  | .97                    | .44 |
| 37              | 23.13                | 10.50 | 1.16                   | .53 |
| 51              | 31.88                | 14.47 | 1.59                   | .72 |

**Metal Shell**

**Contact Arrangements**

(Face view of pin insert)

(Use reverse order for socket side)



**Ordering Information**

**M83513/04 - A 03 C**

**Connector Type**

- 01 - Metal Shell D Plugs with Solder Cup Termination
- 02 - Metal Shell D Sockets with Solder Cup Termination
- 03 - Metal Shell D Plugs with Wire Leads
- 04 - Metal Shell D Sockets with Wire Leads

**Insert Arrangements**

(No. of Contacts)

- A = 9
- B = 15
- C = 21
- D = 25
- E = 31
- F = 37
- G = 51
- H = 100

**Shell Finish**

- C = Cadmium
- N = Electroless Nickel

**Wire Type (Use only for /03 & /04, otherwise omit)**

- 01 - M22759/11-26-9, 18 inches, White (see note below)
- 02 - M22759/11-26-9, 36 inches, White (see note below)
- 03 - M22759/11-26-(-), 18 inches, Color Coded (see note below)
- 04 - M22759/11-26-(-), 36 inches, Color Coded (see note below)
- 05 - QQ-W-343, 25 AWG, 0.5 inch, Gold-Plated
- 06 - QQ-W-343, 25 AWG, 1.0 inch, Gold-Plated
- 07 - QQ-W-343, 25 AWG, 0.5 inch, Tin-Plated
- 08 - QQ-W-343, 25 AWG, 1.0 inch, Tin-Plated
- 09 - M22759/33-26-9, 18 inches, White
- 10 - M22759/33-26-9, 36 inches, White
- 11 - M22759/33-26-(-), 18 inches, Color Coded
- 12 - M22759/33-26-(-), 36 inches, Color Coded
- 13 - M22759/11-26-9, 72 inches, White
- 14 - M22759/11-26-(-), 72 inches, Color Coded
- 15 - M22759/33-26-9, 72 inches, White
- 16 - M22759/33-26-(-), 72 inches, Color Coded

Note: See page 5-31 for M83513 mounting hardware.

**Connector Dimensions - Metal Shell**

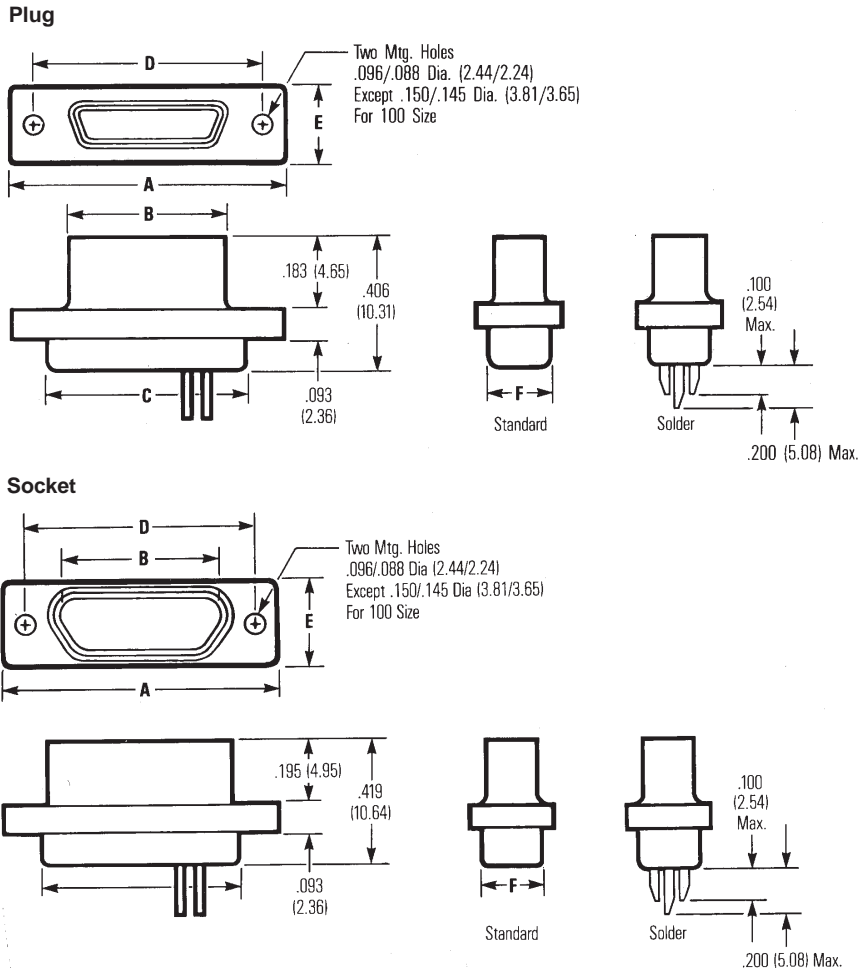

| No. of Contacts | A              |       | B Max. (Plug)<br>Min. (Socket) |       | C<br>+ .010" (.254)<br>- .018" (.457) |       | D              |       | E              |      | F Max. |      |
|-----------------|----------------|-------|--------------------------------|-------|---------------------------------------|-------|----------------|-------|----------------|------|--------|------|
|                 | ± .010" (.254) |       |                                |       |                                       |       | ± .005" (.127) |       | ± .010" (.254) |      |        |      |
|                 | in             | mm    | in                             | mm    | in                                    | mm    | in             | mm    | in             | mm   | in     | mm   |
| 9 Plug          | .775           | 19.68 | .3338                          | 8.48  | .390                                  | 9.91  | .565           | 14.35 | .298           | 7.57 | .270   | 6.68 |
| 9 Socket        | .775           | 19.68 | .3342                          | 8.49  | .390                                  | 9.91  | .565           | 14.35 | .298           | 7.57 | .270   | 6.68 |
| 15 Plug         | .925           | 23.50 | .4838                          | 12.29 | .540                                  | 13.72 | .715           | 18.16 | .298           | 7.57 | .270   | 6.68 |
| 15 Socket       | .925           | 23.50 | .4842                          | 12.30 | .540                                  | 13.72 | .715           | 18.16 | .298           | 7.57 | .270   | 6.68 |
| 21 Plug         | 1.075          | 27.30 | .6338                          | 16.10 | .690                                  | 17.53 | .865           | 21.97 | .298           | 7.57 | .270   | 6.68 |
| 21 Socket       | 1.075          | 27.30 | .6342                          | 16.11 | .690                                  | 17.53 | .865           | 21.97 | .298           | 7.57 | .270   | 6.68 |
| 25 Plug         | 1.175          | 29.84 | .7338                          | 18.64 | .790                                  | 20.07 | .965           | 24.51 | .298           | 7.57 | .270   | 6.68 |
| 25 Socket       | 1.175          | 29.84 | .7342                          | 18.65 | .790                                  | 20.07 | .965           | 24.51 | .298           | 7.57 | .270   | 6.68 |
| 31 Plug         | 1.325          | 33.66 | .8838                          | 22.45 | .940                                  | 23.88 | 1.115          | 28.32 | .298           | 7.57 | .270   | 6.68 |
| 31 Socket       | 1.325          | 33.66 | .8842                          | 22.46 | .940                                  | 23.88 | 1.115          | 28.32 | .298           | 7.57 | .270   | 6.68 |
| 37 Plug         | 1.475          | 37.46 | 1.0338                         | 26.26 | 1.090                                 | 27.69 | 1.265          | 32.13 | .298           | 7.57 | .270   | 6.68 |
| 37 Socket       | 1.475          | 37.46 | 1.0342                         | 26.27 | 1.090                                 | 27.69 | 1.265          | 32.13 | .298           | 7.57 | .270   | 6.68 |
| 51 Plug         | 1.425          | 36.20 | .9838                          | 24.99 | 1.040                                 | 26.42 | 1.215          | 30.86 | .341           | 8.66 | .310   | 7.87 |
| 51 Socket       | 1.425          | 36.20 | .9842                          | 25.00 | 1.040                                 | 26.42 | 1.215          | 30.86 | .341           | 8.66 | .310   | 7.87 |
| 100 Plug        | 2.160          | 54.86 | 1.3838                         | 35.15 | 1.432                                 | 36.38 | 1.800          | 45.71 | .384           | 9.75 | .360   | 9.15 |
| 100 Socket      | 2.160          | 54.86 | 1.3842                         | 35.16 | 1.432                                 | 36.38 | 1.800          | 45.71 | .384           | 9.75 | .360   | 9.15 |

**Panel Mounting Dimensions - Metal Shell**

**Panel Mounting Dimensions**

Pin and socket, rear mounted



Pin and socket, front mounted



Pin, front mounted  
 Socket, rear mounted

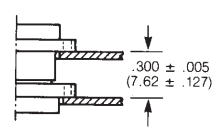

**Front Mounting**

**Panel Cutout Dimensions - Metal Shell**

| No. of Contacts | A               |       | B               |      | C               |       | D               |      |
|-----------------|-----------------|-------|-----------------|------|-----------------|-------|-----------------|------|
|                 | +.004" (.101mm) |       | +.004" (.101mm) |      | +.005" (.127mm) |       | +.005" (.127mm) |      |
|                 | -.000" (.000mm) |       | -.000" (.000mm) |      | -.000" (.000mm) |       | -.000" (.000mm) |      |
|                 | in              | mm    | in              | mm   | in              | mm    | in              | mm   |
| 9               | .408            | 10.36 | .270            | 6.86 | .570            | 14.48 | .089            | 2.26 |
| 15              | .558            | 14.17 | .270            | 6.86 | .720            | 14.48 | .089            | 2.26 |
| 21              | .708            | 17.98 | .270            | 6.86 | .870            | 22.10 | .089            | 2.26 |
| 25              | .808            | 20.52 | .270            | 6.86 | .970            | 24.64 | .089            | 2.26 |
| 31              | .958            | 24.33 | .270            | 6.86 | 1.120           | 28.45 | .089            | 2.26 |
| 37              | 1.108           | 28.14 | .270            | 6.86 | 1.270           | 32.26 | .089            | 2.26 |
| 51              | 1.058           | 26.87 | .315            | 8.00 | 1.220           | 30.99 | .089            | 2.26 |
| 100             | 1.450           | 36.84 | .361            | 9.17 | 1.805           | 45.86 | .117            | 2.97 |



**Rear Mounting**

| No. of Contacts | A               |       | B               |      | C               |       | D               |      |
|-----------------|-----------------|-------|-----------------|------|-----------------|-------|-----------------|------|
|                 | +.004" (.101mm) |       | +.004" (.101mm) |      | +.005" (.127mm) |       | +.005" (.127mm) |      |
|                 | -.000" (.000mm) |       | -.000" (.000mm) |      | -.000" (.000mm) |       | -.000" (.000mm) |      |
|                 | in              | mm    | in              | mm   | in              | mm    | in              | mm   |
| 9               | .408            | 10.36 | .256            | 6.50 | .570            | 14.48 | .089            | 2.26 |
| 15              | .558            | 14.17 | .256            | 6.50 | .720            | 18.29 | .089            | 2.26 |
| 21              | .708            | 17.98 | .256            | 6.50 | .870            | 22.10 | .089            | 2.26 |
| 25              | .808            | 20.52 | .256            | 6.50 | .970            | 24.64 | .089            | 2.26 |
| 31              | .958            | 24.33 | .256            | 6.50 | 1.120           | 28.45 | .089            | 2.26 |
| 37              | 1.108           | 28.14 | .256            | 6.50 | 1.270           | 32.26 | .089            | 2.26 |
| 51              | 1.058           | 26.87 | .300            | 7.62 | 1.220           | 30.99 | .089            | 2.26 |
| 100             | 1.450           | 36.84 | .338            | 8.58 | 1.805           | 45.86 | .117            | 2.97 |



**Edgeboard Mounting**

| No. of Contacts | C               |       | D               |      |
|-----------------|-----------------|-------|-----------------|------|
|                 | +.005" (.127mm) |       | +.005" (.127mm) |      |
|                 | -.000" (.000mm) |       | -.000" (.000mm) |      |
|                 | in              | mm    | in              | mm   |
| 9               | .570            | 14.48 | .089            | 2.26 |
| 15              | .720            | 18.29 | .089            | 2.26 |
| 21              | .870            | 22.10 | .089            | 2.26 |
| 25              | .970            | 24.64 | .089            | 2.26 |
| 31              | 1.120           | 28.45 | .089            | 2.26 |
| 37              | 1.270           | 32.26 | .089            | 2.26 |
| 51              | 1.220           | 30.99 | .089            | 2.26 |
| 100             | 1.805           | 45.86 | .117            | 2.97 |

**Plastic Shell**

**Contact Arrangements**  
 (Face view of pin insert)  
 (Use reverse order for socket side)



**Ordering Information**

**M83513/06-A 04**

**Connector Type**

- 06** - Plastic Shell Plugs with Solder Cup Termination
- 07** - Plastic Shell Sockets with Solder Cup Termination
- 08** - Plastic Shell Plugs with Wire Leads
- 09** - Plastic Shell Sockets with Wire Leads

**Insert Arrangements**

(No. of Contacts)

- A** = 9
- B** = 15
- C** = 21
- D** = 25
- E** = 31
- F** = 37
- G** = 51

**Wire Type (Use only for /08 & /09, otherwise omit)**

- 01** - M22759/11-26-9, 18 inches, White
- 02** - M22759/11-26-9, 36 inches, White
- 03** - M22759/11-26-( ), 18 inches, Color Coded
- 04** - M22759/11-26-( ), 36 inches, Color Coded
- 05** - QQ-W-343, 25 AWG, 0.5 inch, Gold-Plated
- 06** - QQ-W-343, 25 AWG, 1.0 inch, Gold-Plated
- 07** - QQ-W-343, 25 AWG, 0.5 inch, Tin-Plated
- 08** - QQ-W-343, 25 AWG, 1.0 inch, Tin-Plated
- 09** - M22759/33-26-9, 18 inches, White
- 10** - M22759/33-26-9, 36 inches, White
- 11** - M22759/33-26-( ), 18 inches, Color Coded
- 12** - M22759/33-26-( ), 36 inches, Color Coded
- 13** - M22759/11-26-9, 72 inches, White
- 14** - M22759/11-26-( ), 72 inches, Color Coded
- 15** - M22759/33-26-9, 72 inches, White
- 16** - M22759/33-26-( ), 72 inches, Color Coded

Note: See page 5-31 for M83513 mounting hardware.



**Shell Dimensions - (All-Plastic Version)**

**Plug**



**Socket**



| No. of Contacts | A             |       | B Max. (Plug)<br>Min. (Socket) |       | C<br>+.010" (.254)<br>-.018" (.457) |       | D             |       | E             |      | F Max. |      |
|-----------------|---------------|-------|--------------------------------|-------|-------------------------------------|-------|---------------|-------|---------------|------|--------|------|
|                 | ±.010" (.254) |       |                                |       |                                     |       | ±.005" (.127) |       | ±.010" (.254) |      |        |      |
|                 | in            | mm    | in                             | mm    | in                                  | mm    | in            | mm    | in            | mm   | in     | mm   |
| 9 Plug          | .778          | 19.76 | .2918                          | 7.41  | .398                                | 10.11 | .565          | 14.35 | .208          | 5.28 | .173   | 4.39 |
| 9 Socket        | .778          | 19.76 | .2922                          | 7.42  | .398                                | 10.11 | .565          | 14.35 | .208          | 5.28 | .173   | 4.39 |
| 15 Plug         | .928          | 23.57 | .4418                          | 11.22 | .548                                | 13.92 | .715          | 18.16 | .208          | 5.28 | .173   | 4.39 |
| 15 Socket       | .928          | 23.57 | .4422                          | 11.23 | .548                                | 13.92 | .715          | 18.16 | .208          | 5.28 | .173   | 4.39 |
| 21 Plug         | 1.078         | 27.38 | .5918                          | 15.03 | .698                                | 17.73 | .865          | 21.97 | .208          | 5.28 | .173   | 4.39 |
| 21 Socket       | 1.078         | 27.38 | .5922                          | 15.04 | .698                                | 17.73 | .865          | 21.97 | .208          | 5.28 | .173   | 4.39 |
| 25 Plug         | 1.178         | 29.92 | .6918                          | 17.57 | .798                                | 20.27 | .965          | 24.51 | .208          | 5.28 | .173   | 4.39 |
| 25 Socket       | 1.178         | 29.92 | .6922                          | 17.58 | .798                                | 20.27 | .965          | 24.51 | .208          | 5.28 | .173   | 4.39 |
| 31 Plug         | 1.328         | 33.73 | .8418                          | 21.38 | .948                                | 24.08 | 1.115         | 28.32 | .208          | 5.28 | .173   | 4.39 |
| 31 Socket       | 1.328         | 33.73 | .8422                          | 21.39 | .948                                | 24.08 | 1.115         | 28.32 | .208          | 5.28 | .173   | 4.39 |
| 37 Plug         | 1.478         | 37.54 | .9918                          | 25.19 | 1.098                               | 27.89 | 1.265         | 32.13 | .208          | 5.28 | .173   | 4.39 |
| 37 Socket       | 1.478         | 37.54 | .9922                          | 25.20 | 1.098                               | 27.89 | 1.265         | 32.13 | .208          | 5.28 | .173   | 4.39 |
| 51 Plug         | 1.428         | 36.27 | .9418                          | 23.92 | 1.048                               | 26.62 | 1.215         | 30.86 | .250          | 6.35 | .220   | 5.59 |
| 51 Socket       | 1.428         | 36.27 | .9422                          | 23.93 | 1.048                               | 26.62 | 1.215         | 30.86 | .250          | 6.35 | .220   | 5.59 |



**Panel Mounting Dimensions - All-Plastic**

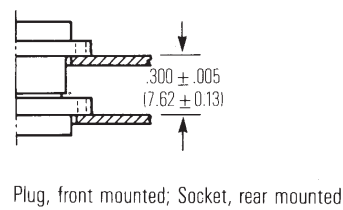
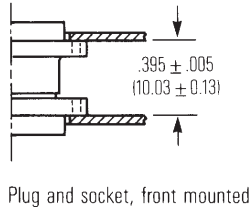
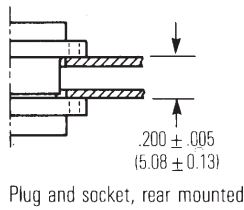

**Panel Cutout Dimensions**

| No. of Contacts | A<br>+.004" (.101mm)<br>-.000" (.000mm) |       | B<br>+.004" (.101mm)<br>-.000" (.000mm) |      | C<br>+.005" (.127mm)<br>-.000" (.000mm) |       |
|-----------------|---|-------|---|------|---|-------|
|                 | in                                      | mm    | in                                      | mm   | in                                      | mm    |
| 9               | .408                                    | 10.36 | .172                                    | 4.37 | .570                                    | 14.48 |
| 15              | .558                                    | 14.17 | .172                                    | 4.37 | .720                                    | 18.29 |
| 21              | .708                                    | 17.98 | .172                                    | 4.37 | .870                                    | 22.10 |
| 25              | .808                                    | 20.52 | .172                                    | 4.37 | .970                                    | 24.64 |
| 31              | .958                                    | 24.33 | .172                                    | 4.37 | 1.120                                   | 28.45 |
| 37              | 1.108                                   | 28.14 | .172                                    | 4.37 | 1.270                                   | 32.26 |
| 51              | 1.058                                   | 26.87 | .215                                    | 5.46 | 1.220                                   | 30.99 |

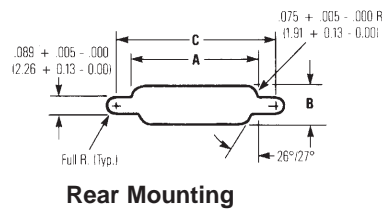

**Rear Cutout Dimensions**

| No. of Contacts | A<br>+.004" (.101mm)<br>-.000" (.000mm) |       | B<br>+.004" (.101mm)<br>-.000" (.000mm) |      | C<br>+.005" (.127mm)<br>-.000" (.000mm) |       |
|-----------------|---|-------|---|------|---|-------|
|                 | in                                      | mm    | in                                      | mm   | in                                      | mm    |
| 9               | .373                                    | 9.47  | .216                                    | 5.49 | .570                                    | 14.48 |
| 15              | .523                                    | 13.28 | .216                                    | 5.49 | .720                                    | 18.29 |
| 21              | .674                                    | 17.12 | .216                                    | 5.49 | .870                                    | 22.10 |
| 25              | .774                                    | 19.66 | .216                                    | 5.49 | .970                                    | 24.64 |
| 31              | .924                                    | 23.47 | .216                                    | 5.49 | 1.120                                   | 28.45 |
| 37              | 1.074                                   | 27.28 | .216                                    | 5.49 | 1.270                                   | 32.26 |
| 51              | 1.024                                   | 26.01 | .259                                    | 6.58 | 1.220                                   | 30.99 |

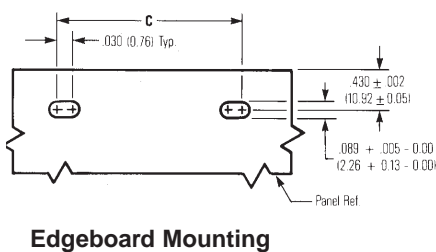

**Edgeboard Mounting Cutout Dimensions**

| No. of Contacts | D<br>+.005" (.127mm)<br>-.000" (.000mm) |       |
|-----------------|---|-------|
|                 | in                                      | mm    |
| 9               | .570                                    | 14.48 |
| 15              | .720                                    | 18.29 |
| 21              | .870                                    | 22.10 |
| 25              | .970                                    | 24.64 |
| 31              | 1.120                                   | 28.45 |
| 37              | 1.270                                   | 32.26 |
| 51              | 1.220                                   | 30.99 |

**Terminal Block**

**Contact Arrangements**

(Face view of pin insert)  
(Use reverse order for socket side)



**Ordering Information**

**M83513/10 - C 02 C N**

**Connector Description**

- 10 = Plug, 9-37 Pos., Narrow Profile, Rt. Angle
- 11 = Plug, 51 Pos., Narrow Profile, Rt. Angle
- 12 = Plug, 100 Pos., Narrow Profile, Rt. Angle
- 13 = Socket, 9-37 Pos., Narrow Profile, Rt. Angle
- 14 = Socket, 51 Pos., Narrow Profile, Rt. Angle
- 15 = Socket, 100 Pos., Narrow Profile, Rt. Angle
- 16 = Plug, 9-37 Pos., Std. Profile, Rt. Angle
- 17 = Plug, 51 Pos., Std. Profile, Rt. Angle
- 18 = Plug, 100 Pos., Std. Profile, Rt. Angle
- 19 = Socket, 9-37 Pos., Std. Profile, Rt. Angle
- 20 = Socket, 51 Pos., Std. Profile, Rt. Angle
- 21 = Socket, 100 Pos., Std. Profile, Rt. Angle
- 22 = Plug, 9-37 Pos., Straight Mount
- 23 = Plug, 51 Pos., Straight Mount
- 24 = Plug, 100 Pos., Straight Mount
- 25 = Socket, 9-37 Pos., Straight Mount
- 26 = Socket, 51 Pos., Straight Mount
- 27 = Socket, 100 Pos., Straight Mount

**Hardware**

- N = No Jackpost
- P = Jackpost Attached

**Shell Finish**

- C = Cadmium
- N = Electroless Nickel

**Termination Length**

- 01 = 0.109
- 02 = 0.140
- 03 = 0.172

**Insert Arrangement Length**  
(No. of Contacts)

- A = 9
- B = 15
- C = 21
- D = 25
- E = 31
- F = 37
- G = 51
- H = 100

**90° Termination**  
**(/16-/21)**



**Recommended Board Layout**



(As Viewed from Bottom  
of Terminal Block)

Typ. Hole Dia. = .040" (1.02 mm)

NOTE: For additional connector dimensions, see page 5-22.

| No. of<br>Contacts | A<br>Max. |       | B<br>± .007 (0.18) |       | C<br>± .005 (0.13) |       | F<br>Max. |       |
|--------------------|-----------|-------|--------------------|-------|--------------------|-------|-----------|-------|
|                    | in        | mm    | in                 | mm    | in                 | mm    | in        | mm    |
| 9 Plug             | 1.390     | 35.31 | 1.150              | 29.21 | .565               | 14.35 | .465      | 11.81 |
| 9 Socket           | 1.390     | 35.31 | 1.150              | 29.21 | .565               | 14.35 | .465      | 11.81 |
| 15 Plug            | 1.540     | 39.12 | 1.300              | 33.02 | .715               | 18.16 | .465      | 11.81 |
| 15 Socket          | 1.540     | 39.12 | 1.300              | 33.02 | .715               | 18.16 | .465      | 11.81 |
| 21 Plug            | 1.690     | 42.93 | 1.450              | 36.83 | .865               | 21.97 | .465      | 11.81 |
| 21 Socket          | 1.690     | 42.93 | 1.450              | 36.83 | .865               | 21.97 | .465      | 11.81 |
| 25 Plug            | 1.790     | 45.47 | 1.550              | 39.37 | .965               | 24.51 | .465      | 11.81 |
| 25 Socket          | 1.790     | 45.47 | 1.550              | 39.37 | .965               | 24.51 | .465      | 11.81 |
| 31 Plug            | 2.040     | 51.82 | 1.800              | 45.72 | 1.115              | 28.32 | .465      | 11.81 |
| 31 Socket          | 2.040     | 51.82 | 1.800              | 45.72 | 1.115              | 28.32 | .465      | 11.81 |
| 37 Plug            | 2.340     | 59.44 | 2.100              | 53.34 | 1.265              | 32.13 | .465      | 11.81 |
| 37 Socket          | 2.340     | 59.44 | 2.100              | 53.34 | 1.265              | 32.13 | .465      | 11.81 |
| 51 Plug            | 1.875     | 47.63 | 1.600              | 40.64 | 1.215              | 30.86 | .565      | 14.35 |
| 51 Socket          | 1.875     | 47.63 | 1.600              | 40.64 | 1.215              | 30.86 | .565      | 14.35 |
| 100 Plug           | 2.780     | 70.61 | 2.500              | 63.50 | 1.800              | 45.72 | .765      | 19.43 |
| 100 Socket         | 2.780     | 70.61 | 2.500              | 63.50 | 1.800              | 45.72 | .765      | 19.43 |

| No. of<br>Contacts | G<br>Max. |       | H<br>Max. |      | J<br>± .005 (0.13) |      | K<br>± .015 |      |
|--------------------|-----------|-------|-----------|------|--------------------|------|-------------|------|
|                    | in        | mm    | in        | mm   | in                 | mm   | in          | mm   |
| 9 Plug             | .308      | 7.82  | .190      | 4.83 | .096               | 2.44 | .125        | 3.18 |
| 9 Socket           | .308      | 7.82  | .200      | 5.08 | .096               | 2.44 | .125        | 3.18 |
| 15 Plug            | .308      | 7.82  | .190      | 4.83 | .096               | 2.44 | .125        | 3.18 |
| 15 Socket          | .308      | 7.82  | .200      | 5.08 | .096               | 2.44 | .125        | 3.18 |
| 21 Plug            | .308      | 7.82  | .190      | 4.83 | .096               | 2.44 | .125        | 3.18 |
| 21 Socket          | .308      | 7.82  | .200      | 5.08 | .096               | 2.44 | .125        | 3.18 |
| 25 Plug            | .308      | 7.82  | .190      | 4.83 | .096               | 2.44 | .125        | 3.18 |
| 25 Socket          | .308      | 7.82  | .200      | 5.08 | .096               | 2.44 | .125        | 3.18 |
| 31 Plug            | .308      | 7.82  | .190      | 4.83 | .096               | 2.44 | .125        | 3.18 |
| 31 Socket          | .308      | 7.82  | .200      | 5.08 | .096               | 2.44 | .125        | 3.18 |
| 37 Plug            | .308      | 7.82  | .190      | 4.83 | .096               | 2.44 | .125        | 3.18 |
| 37 Socket          | .308      | 7.82  | .200      | 5.08 | .096               | 2.44 | .125        | 3.18 |
| 51 Plug            | .351      | 8.92  | .190      | 4.83 | .096               | 2.44 | .125        | 3.18 |
| 51 Socket          | .351      | 8.92  | .200      | 5.08 | .096               | 2.44 | .125        | 3.18 |
| 100 Plug           | .394      | 10.00 | .190      | 4.83 | .125               | 3.18 | .225        | 5.72 |
| 100 Socket         | .394      | 10.00 | .200      | 5.08 | .125               | 3.18 | .225        | 5.72 |

**Straight (180°) Termination**  
**(I22-I27)**



**Recommended Board Layout**

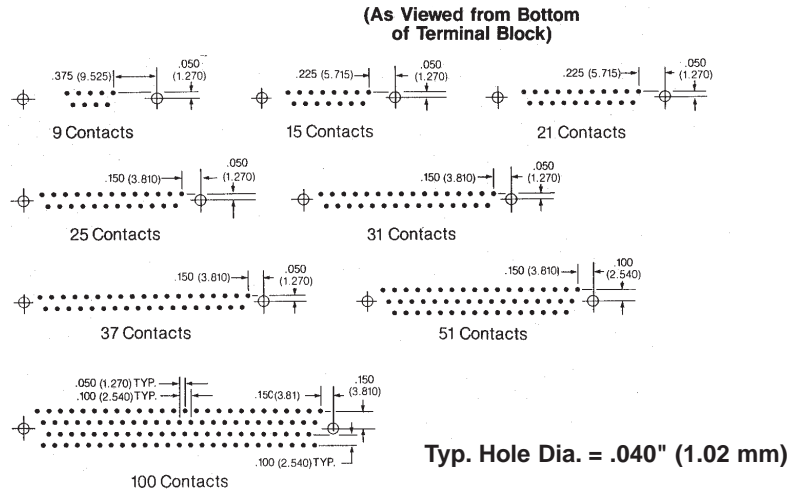

NOTE: For additional connector dimensions, see page 5-22.

| No. of<br>Contacts | A<br>Max. |       | B<br>± .007 (0.18) |       | C<br>± .005 (0.13) |       | D<br>Max. |       | G<br>Max. |       |
|--------------------|-----------|-------|--------------------|-------|--------------------|-------|-----------|-------|-----------|-------|
|                    | in        | mm    | in                 | mm    | in                 | mm    | in        | mm    | in        | mm    |
| 9 Plug             | 1.390     | 35.31 | 1.150              | 29.21 | .565               | 14.35 | .885      | 22.48 | .308      | 7.75  |
| 9 Socket           | 1.390     | 35.31 | 1.150              | 29.21 | .565               | 14.35 | .885      | 22.48 | .308      | 7.75  |
| 15 Plug            | 1.390     | 35.31 | 1.150              | 29.21 | .715               | 18.16 | .945      | 24.0  | .308      | 7.75  |
| 15 Socket          | 1.390     | 35.31 | 1.150              | 29.21 | .715               | 18.16 | .945      | 24.0  | .308      | 7.75  |
| 21 Plug            | 1.690     | 42.93 | 1.450              | 36.83 | .865               | 21.97 | 1.185     | 30.09 | .308      | 7.75  |
| 21 Socket          | 1.690     | 42.93 | 1.450              | 36.83 | .865               | 21.97 | 1.185     | 30.09 | .308      | 7.75  |
| 25 Plug            | 1.740     | 44.20 | 1.500              | 38.10 | .965               | 24.51 | 1.275     | 32.38 | .308      | 7.75  |
| 25 Socket          | 1.740     | 44.20 | 1.500              | 38.10 | .965               | 24.51 | 1.275     | 32.38 | .308      | 7.75  |
| 31 Plug            | 2.040     | 51.82 | 1.800              | 45.72 | 1.115              | 28.32 | 1.575     | 40.00 | .308      | 7.75  |
| 31 Socket          | 2.040     | 51.82 | 1.800              | 45.72 | 1.115              | 28.32 | 1.576     | 40.00 | .308      | 7.75  |
| 37 Plug            | 2.340     | 59.44 | 2.100              | 53.34 | 1.265              | 32.13 | 1.875     | 47.62 | .308      | 7.75  |
| 37 Socket          | 2.340     | 59.44 | 2.100              | 53.34 | 1.265              | 32.13 | 1.875     | 47.62 | .308      | 7.75  |
| 51 Plug            | 2.270     | 57.66 | 2.000              | 50.80 | 1.215              | 30.86 | 1.775     | 45.08 | .351      | 8.92  |
| 51 Socket          | 2.270     | 57.66 | 2.000              | 50.80 | 1.215              | 30.86 | 1.775     | 45.08 | .351      | 8.92  |
| 100 Plug           | 3.070     | 77.98 | 2.800              | 71.12 | 1.800              | 45.72 | 2.585     | 65.55 | .455      | 11.56 |
| 100 Socket         | 3.070     | 77.98 | 2.800              | 71.12 | 1.800              | 45.72 | 2.585     | 65.65 | .455      | 11.56 |

| No. of<br>Contacts | H<br>Max. |      | J<br>± .005 (0.13) |      | K<br>Max. |      | L<br>Max. |       |
|--------------------|-----------|------|--------------------|------|-----------|------|-----------|-------|
|                    | in        | mm   | in                 | mm   | in        | mm   | in        | mm    |
| 9 Plug             | .190      | 4.83 | .096               | 2.44 | .165      | 4.19 | .355      | 9.02  |
| 9 Socket           | .200      | 5.08 | .096               | 2.44 | .165      | 4.19 | .355      | 9.02  |
| 15 Plug            | .190      | 4.83 | .096               | 2.44 | .165      | 4.19 | .355      | 9.02  |
| 15 Socket          | .200      | 5.08 | .096               | 2.44 | .165      | 4.19 | .355      | 9.02  |
| 21 Plug            | .190      | 4.83 | .096               | 2.44 | .165      | 4.19 | .355      | 9.02  |
| 21 Socket          | .200      | 5.08 | .096               | 2.44 | .165      | 4.19 | .355      | 9.02  |
| 25 Plug            | .190      | 4.83 | .096               | 2.44 | .165      | 4.19 | .355      | 9.02  |
| 25 Socket          | .200      | 5.08 | .096               | 2.44 | .165      | 4.19 | .355      | 9.02  |
| 31 Plug            | .190      | 4.83 | .096               | 2.44 | .165      | 4.19 | .355      | 9.02  |
| 31 Socket          | .200      | 5.08 | .096               | 2.44 | .165      | 4.19 | .355      | 9.02  |
| 37 Plug            | .190      | 4.83 | .096               | 2.44 | .165      | 4.19 | .355      | 9.02  |
| 37 Socket          | .200      | 5.08 | .096               | 2.44 | .165      | 4.19 | .355      | 9.02  |
| 51 Plug            | .190      | 4.83 | .096               | 2.44 | .165      | 4.19 | .355      | 9.02  |
| 51 Socket          | .200      | 5.08 | .096               | 2.44 | .165      | 4.19 | .355      | 9.02  |
| 100 Plug           | .190      | 4.83 | .125               | 3.18 | .300      | 7.62 | .550      | 13.97 |
| 100 Socket         | .200      | 5.08 | .125               | 3.18 | .300      | 7.62 | .550      | 13.97 |

**90° Narrow Termination  
 (/10-15)**



**Recommended Board Layout**



**(As Viewed from Bottom  
 of Terminal Block)**

NOTE: For additional connector dimensions, see page 5-22.

Typ. Hole Dia. = .040" (1.02 mm)

| No. of<br>Contacts | A<br>Max. |       | B<br>± .005 (0.13) |       | C<br>Max. |       |
|--------------------|-----------|-------|--------------------|-------|-----------|-------|
|                    | in        | mm    | in                 | mm    | in        | mm    |
| 9 Plug             | .785      | 19.94 | .565               | 14.35 | .308      | 7.82  |
| 9 Socket           | .785      | 19.94 | .565               | 14.35 | .308      | 7.82  |
| 15 Plug            | .935      | 23.75 | .715               | 18.16 | .308      | 7.82  |
| 15 Socket          | .935      | 23.75 | .715               | 18.16 | .308      | 7.82  |
| 21 Plug            | 1.085     | 27.56 | .865               | 21.97 | .308      | 7.82  |
| 21 Socket          | 1.085     | 27.56 | .865               | 21.97 | .308      | 7.82  |
| 25 Plug            | 1.085     | 30.10 | .965               | 24.51 | .308      | 7.82  |
| 25 Socket          | 1.185     | 30.10 | .965               | 24.51 | .308      | 7.82  |
| 31 Plug            | 1.335     | 33.91 | 1.115              | 28.32 | .308      | 7.82  |
| 31 Socket          | 1.335     | 33.91 | 1.115              | 28.32 | .308      | 7.82  |
| 37 Plug            | 1.485     | 37.72 | 1.265              | 32.13 | .308      | 7.82  |
| 37 Socket          | 1.485     | 37.72 | 1.265              | 32.13 | .308      | 7.82  |
| 51 Plug            | 1.435     | 36.45 | 1.215              | 30.86 | .351      | 8.92  |
| 51 Socket          | 1.435     | 36.45 | 1.215              | 30.86 | .351      | 8.92  |
| 100 Plug           | 2.175     | 55.25 | 1.800              | 45.72 | .394      | 10.00 |
| 100 Socket         | 2.175     | 55.25 | 1.800              | 45.72 | .394      | 10.00 |

| No. of<br>Contacts | F<br>± .010 (0.25) |      | G<br>± .010 (0.25) |       | H<br>Max. |       | J<br>± .005 (0.13) |      |
|--------------------|--------------------|------|--------------------|-------|-----------|-------|--------------------|------|
|                    | in                 | mm   | in                 | mm    | in        | mm    | in                 | mm   |
| 9 Plug             | .230               | 5.84 | .250               | 6.35  | .420      | 10.67 | .096               | 2.44 |
| 9 Socket           | .230               | 5.84 | .250               | 6.35  | .420      | 10.67 | .096               | 2.44 |
| 15 Plug            | .130               | 3.30 | .250               | 6.35  | .420      | 10.67 | .096               | 2.44 |
| 15 Socket          | .130               | 3.30 | .250               | 6.35  | .420      | 10.67 | .096               | 2.44 |
| 21 Plug            | .130               | 3.30 | .250               | 6.35  | .420      | 10.67 | .096               | 2.44 |
| 21 Socket          | .130               | 3.30 | .250               | 6.35  | .420      | 10.67 | .096               | 2.44 |
| 25 Plug            | .130               | 3.30 | .250               | 6.35  | .420      | 10.67 | .096               | 2.44 |
| 25 Socket          | .130               | 3.30 | .250               | 6.35  | .420      | 10.67 | .096               | 2.44 |
| 31 Plug            | .130               | 3.30 | .250               | 6.35  | .520      | 13.21 | .996               | 2.44 |
| 31 Socket          | .130               | 3.30 | .250               | 6.35  | .520      | 13.21 | .096               | 2.44 |
| 37 Plug            | .130               | 3.30 | .250               | 6.35  | .520      | 13.21 | .096               | 2.44 |
| 37 Socket          | .130               | 3.30 | .250               | 6.35  | .520      | 13.21 | .096               | 2.44 |
| 51 Plug            | .150               | 3.81 | .300               | 7.62  | .650      | 16.51 | .096               | 2.44 |
| 51 Socket          | .150               | 3.81 | .300               | 7.62  | .650      | 16.51 | .096               | 2.44 |
| 100 Plug           | .200               | 5.08 | .400               | 10.16 | 1.000     | 25.40 | .125               | 3.18 |
| 100 Socket         | .200               | 5.08 | .400               | 10.16 | 1.000     | 25.40 | .125               | 3.18 |

**Mounting Hardware**



High Profile Jackscrew



Low Profile Jackscrew



Removable Jackpost

**Ordering Information**

| Type      | Style        | Screwhead    | Thread | Military Part No. |
|-----------|--------------|--------------|--------|-------------------|
| Jackscrew | Low Profile  | Recessed Hex | 2/56   | M83513/5-02       |
| Jackscrew | High Profile | Recessed Hex | 2/56   | M83513/5-03       |
| Jackscrew | Low Profile  | Slotted      | 2/56   | M83513/5-05       |
| Jackscrew | High Profile | Slotted      | 2/56   | M83513/5-06       |
| Jackpost  | --           | --           | 2/56   | M83513/5-07       |
| Jackscrew | Low Profile  | Hex          | 4/40*  | M83513/5-12       |
| Jackscrew | High Profile | Hex          | 4/40*  | M83513/5-13       |
| Jackscrew | Low Profile  | Slotted      | 4/40*  | M83513/5-15       |
| Jackscrew | High Profile | Slotted      | 4/40*  | M83513/5-16       |
| Jackpost  | --           | --           | 4/40*  | M83513/5-17       |

\*100 Size Only

# Dura-Con High Reliability All-Plastic & Metal Shell

.050" (1.27mm) Density  
Connector Saver



## FEATURES

- Designed to significantly reduce damage to already mounted Dura-Con connectors during routine system tests.
- Eliminates numerous mating & unmating cycles experienced by connectors on test harnesses.
- Plug connector on one end, socket connector on the other.
- Available in all-plastic (polyester) or in metal shell with diallyl phthalate or polyester insulators (both UL94V-0 rated).
- Locking hardware must be ordered separately.



## MATERIALS

**Insulator:** UL94V-0 glass-filled polyester or diallyl phthalate  
**Contacts:** Copper alloy  
**Contact Plating:** .000050 in gold  
**Shell (Metal Only):** Aluminum alloy  
**Shell Plating:** Yellow chromate over cadmium

## ENVIRONMENTAL

**Operating Temperature:** -55°C to +135°C

## ELECTRICAL

**Current Rating:** 3 Amps maximum  
**Withstanding Voltage:** 600 VAC RMS @ sea level  
**Contact Resistance:** 8 milliohms maximum

## MECHANICAL

**Individual Contact:** Insertion force, 6 oz. (170.40 g) maximum;  
 Withdrawal force 0.5 oz. (14.20 g) minimum  
**Mating / Unmating Forces:** See previous tables



| No. of<br>Contacts | Metal Shell                      |                                       | All Plastic                           |
|--------------------|----------------------------------|---------------------------------------|---------------------------------------|
|                    | Diallyl Phthalate<br>Catalog No. | Glass-Filled Polyester<br>Catalog No. | Glass-Filled Polyester<br>Catalog No. |
| 9                  | DCCM9CS                          | DCDM9CS                               | DCDA9CS                               |
| 15                 | DCCM15CS                         | DCDM15CS                              | DCDA15CS                              |
| 21                 | DCCM21CS                         | DCDM21CS                              | DCDA21CS                              |
| 25                 | DCCM25CS                         | DCDM25CS                              | DCDA25CS                              |
| 31                 | DCCM31CS                         | DCDM31CS                              | DCDA31CS                              |
| 37                 | DCCM37CS                         | DCDM37CS                              | DCDA37CS                              |
| 51                 | DCCM51CS                         | DCDM51CS                              | DCDA51CS                              |
| 100                | DCCM100CS                        | DCDM100CS                             | -                                     |



**Dura-Con  
High Reliability  
Microedge Connectors**

.050" (1.27mm) Density  
PC Board Mount  
Metal Shell



FEATURES

- **Variety of available PC board mounting styles.**
  - “Coke Bottle” for edge mounting on double-sided PCBs
  - Right-angle (90°) mounting for single- or double-sided daughter boards
  - “Claw Foot” leads
  - Gold-plated solid copper wire pigtails
- **Harnessing capabilities exist for both plug & socket.**
- **Standard sizes are 128 and 184 positions.**
- **Utilizes high-reliability Dura-Con twist pin contact system assuring electrical continuity under extreme shock and vibration.**
- **Aluminum shells and diallyl phthalate insulators make Dura-Con microedge connectors ideal for airborne or space applications.**
- **Microedge metal shell connectors meet the requirement of MIL-C-55302.**

MATERIALS

**Insulator:** UL94V-0 glass-filled polyester or diallyl phthalate per MIL-M-14 (green)  
**Contacts:** Copper alloy  
**Contact Plating:** .000050 in Gold  
**Shell:** Aluminum alloy  
**Shell Plating:** Electroless Nickel

ENVIRONMENTAL

**Operating Temperature:** -55°C to +135°C

ELECTRICAL

**Current Rating:** 3 Amps maximum  
**Withstanding Voltage:** 600 VAC RMS @ sea level, 300 VAC @ 70,000 ft.  
**Contact Resistance:** 8 milliohms maximum

MECHANICAL

**Insertion/Withdrawal Force:**  
 6 oz. (170.40 g[f]) maximum insertion force, per contact;  
 0.5 oz. (14.20 g[f]) minimum withdrawal force, per contact



**128 Contact Receptacle (Right Angle)**



**Side View and Termination Grid Pattern**



**128 Contact Receptacle (Stranded Insulated Wire)**



**Side View**

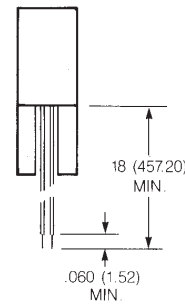

**128 Contact Plug (Claw Foot)**



**Side View and Termination Grid Pattern**



**Dura-Con**  
**High Reliability**  
**Microedge Connectors**

.050" (1.27mm) Density  
 PC Board Mount  
 Metal Shell



**128 Contact Plug (Stranded Insulated Wire)**



**Side View**

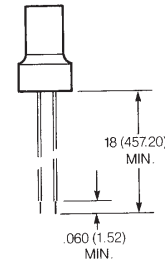

**184 Contact Receptacle (Coke Bottle)**



**Side View**



Recommended PCB thickness .047-.062.  
 Consult factory for other thicknesses.

**184 Contact Receptacle (Stranded Insulated Wire)**



**Side View**

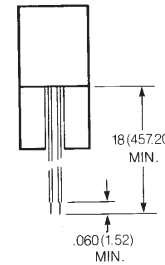

**184 Contact Plug (Claw Foot)**



**Side View and Termination Grid Pattern**



\* Narrow Version (DNEB) .250 Wide

5

**Dura-Con**  
**High Reliability**  
**Microedge Connectors**

.050" (1.27mm) Density  
 PC Board Mount  
 Metal Shell



**184 Contact Plug (Standard Insulated Wire)**



**Side View**



\* Narrow Version (DNEB) .250 Wide

**Shell Polarization Kit**

| Order No. | "L"  | Used On          |
|-----------|------|------------------|
| DNEBP0L1  | .250 | DNEB Narrow Only |
| DMEBP0L1  | .312 | DMEB Std. Width  |

**Key**



**Mounting Hardware**

**Removable Jackscrew/Jackpost Assembly**



Consult factory if required.

**Standard Jackscrew/Jackpost Assembly**



Plug with Jackscrew



Receptacle with Jackscrew

**Ordering Information**

**DMEB 1-128 P 6 E 2 180**

**Series Prefix**  
 DMEB = Microedgeboard  
 DNEB = Microedgeboard, Narrow (184 Only)

**Contact Spacing**  
 1 = .050" (1.27mm) centers  
 128/184  
 2 = .100" (2.54mm) centers  
 64/92 (every other contact hole)  
 For other contact spacing accommodations, consult the factory.

**No. of Contacts**  
 128, 184

**Contact Type**  
 P = Pin  
 S = Socket

**Wire Size in AWG**  
 5 = 25 AWG Solid Copper  
 6 = 26 AWG Stranded Wire  
 S = Solder Cup

\*Indicates Cinch std Option

**Lead Length in Inches**

**Termination, Color of Finish**  
 1 = White  
 \*2 = Yellow  
 3 = Tin-Plated  
 \*4 = Gold-Plated (Solid Copper Wire Only)  
 \*5 = Color Coded per MIL-Std. 681, System 1

**Wire Type/Termination Style**  
 C = Solid Copper  
 E = MIL-W-16878/4, 7 Strand  
 BS = PC Board (Coke Bottle)  
 BRA = PC Board Right-Angle (Formed to "A" Side)  
 BRB = PC Board Right-Angle (Formed to "B" Side)  
 W = PC Board (Claw Foot)

**Dura-Con  
High Reliability  
Strip Connectors**

.050" (1.27mm) Density  
Solder Cup/Wire  
All-Plastic



FEATURES

- *Lightweight.*
- *Slim Profile.*
- *High-Density Interconnect.*
- *High-reliability Dura-Con twist pin contact system for extreme shock & vibration applications.*
- *Optional polarization with guide pins to prevent mismatching connectors.*
- *Plug & socket available in sizes from 1 to 60 positions.*

MATERIALS

**Insulator:** UL94V-0 glass-filled polyester  
**Contacts:** Copper alloy  
**Contact Plating:** .000050 in gold



ENVIRONMENTAL

**Operating Temperature:** -55°C to +135°C



ELECTRICAL

**Current Rating:** 3 Amps maximum  
**Withstanding Voltage:** 600 VAC @ sea level;  
150 VAC @ 70,000 ft.  
**Contact Resistance:** 8 milliohms maximum

MECHANICAL

**Insertion & Withdrawal Force (Per Contact):**  
6 oz. (170.40 g[f]) maximum insertion;  
0.5 oz. (14.20 g[f]) minimum withdrawal

# Dura-Con High Reliability Strip Connectors

.050" (1.27mm) Density  
Solder Cup/Wire  
All Plastic



## Dimensions

### Socket Connector



### Pin Connector



### 24 Gauge Stainless Steel Guide Pin\*



NOTE: Dimension A is number of positions less 1 multiplied by .050

\* Assembly in socket connector only.

## Ordering Information



\* - Indicates Cinch std. option.  
\*\* - Consult factory for larger sizes and multi-row.

# MINIATURE RIBBONS

IDC SUPERIBBON™ & Metal Shell

Vertical Mount Compliant Pin

Solder Cup

Right-Angle Solder Tail

Wire Wrap

Vertical Mount Solder Tail

Accessories & Application Tooling



**Cinch**

**.085 in. (2.16mm)  
Density  
Miniature Ribbon**

Introduction



The Miniature Ribbon connector has been a mainstay in the electronics industry for decades. First widely used in telecommunications, it has proven itself to be a very reliable interconnection system, with generous wiping action, high contact pressure, large mating surface area in a relatively compact format, and polarized shells to ensure proper orientation in mating.

The Miniature Ribbon connector gets its name from the ribbon-like shape of the mating end of the contact. It is a derivative of the first connector design to incorporate this type of interconnection where mating members are equally flexible. Each contact is backed up by its respective insulator, resulting in high contact pressure without concern over relaxation that can occur with a beam or cantilever design. Industry standard sizes for this product are 14, 24, 36, 50, and 64 positions. Cinch adheres to industry-standard contact numbering and mating geometry.

Cinch has led the way in making the Miniature Ribbon connector one of the most cost-effective yet high-quality connector systems in the industry. From its roots in the telecommunications industry where it is traditionally known as the “Key Telephone” style connector (USOC Type RJ21), Cinch’s innovations in termination, latching, and accessories have helped make the Miniature Ribbon family the choice for applications in computers and instrumentation as well. It is called out as the standard connector for a parallel printer interface (IEEE 1284-B, also known as “Centronics”), multi-purpose peripheral interface (SCSI-1), and instrumentation interface (IEEE-488, also known as “GPIB”).

Cinch manufactures one of the most diverse lines of Miniature Ribbon products in the industry. From SUPERIBBON™ all-plastic products with solderless termination to full-metal shell products with solder terminations, and even filtered versions designed to solve EMI problems, Cinch can provide the Miniature Ribbon products you need.

Several options are available so you can find the right Cinch Miniature Ribbon product for your application. Cinch’s method of integrating features into the product often *reduces overall installed cost compared to other alternatives*. Select the termination type, the configuration, the latching and mounting methods to be used, and any accessories that would make the installation of the connector complete.



Connector Face Views

| All-Plastic | Metal Shell |                                     |
|-------------|-------------|-------------------------------------|
| 6-6         | 6-14        | IDC                                 |
|             | 6-24        | Solder Cup                          |
| 6-30        | 6-30        | Wire Wrap                           |
| 6-38        | 6-34        | Vertical-Mount Solder Tail          |
| 6-42        | 6-42        | Vertical-Mount Compliant Pin        |
|             | 6-46        | Right Angle Solder Tail             |
| 6-48        |             | Filtered Vertical-Mount Solder-Tail |
| 6-48        |             | Male/Female Adapter                 |

Accessories information starts on page 6-51.  
Tooling Information starts on page 6-54.

SUPERIBBON is a trademark of Cinch Connectors, Inc. Systems, Inc.



### Termination Options

Cinch offers products suitable for termination by various methods:

- IDC -- Cinch's patented Insulation Displacement Contact (IDC) provides reliable, low-cost termination to discrete wire, either loose or in jacketed cable. With the use of special tools designed for field and/or factory use, wires can be terminated to the connector without individual cutting, stripping, or soldering. Reliable performance is ensured by the exclusive 4-point contact termination, and the built-in wire strain relief prevents mechanical stress from reaching the termination points.



Termination section of IDC contact

Cinch IDC connectors are available in both Metal Shell and All-Plastic SUPERIBBON versions. They are available to terminate solid conductor (some 22 AWG, and 24-26 AWG) or stranded (24-28 AWG) wire. Likewise, a full range of termination tooling is available.

- Wire Wrap -- This termination style, which is also solderless, is often used when termination must be done in place, such as in wired backplanes, etc. Cinch wire-wrap terminated Miniature Ribbon connectors are available in both Metal Shell and All-Plastic versions, with either .025" or .045" sq. tails.
- Solder Cup -- For those applications where nothing but the lowest termination resistance will do, Cinch offers Metal Shell Miniature Ribbon connectors with solder-cup termination. Available with or without insulator barriers between contact terminal areas, these products will accept up to one 22 AWG solid wire or one 24 AWG stranded wire per contact.
- Solder Tail -- This style allows Cinch Miniature Ribbon connectors to be through-hole soldered directly to a printed circuit board. They are available in Vertical Mount and Right-Angle Mount versions.
- Compliant Pin -- This style allows termination to a printed circuit board without soldering. This eliminates the costly cleaning/rework associated with soldering, yet the Cinch modified-C type termination will not damage the board's plating as standard press-fit terminals can.



Piercing/compressing action as wire is pressed into contact

### Configuration

Cinch Miniature Ribbon and SUPERIBBON products are available as connectors alone to be mounted to a system's panel or printed circuit board, or complete with hoods for use on various types of cable assemblies. Hooded products are available with cable exits straight back 180 degrees from the mating face (Top-Entry) or with cable exits on either end, 90, or 270 degrees from the mating face (Standard and Reverse Orientation End-Entry). Finally, overmold kits are available allowing you to efficiently and economically manufacture your own "custom" cable assemblies.

End-Entry SuperShield™ connectors and All-Plastic SUPERIBBON connectors feature an integral cable clamp that prevents stress on the termination area, even when the hood is removed during assembly or repair.

Top-Entry products have cable clamps built into the hoods. These clamps are adjustable to fit a range of cable sizes.

### Latching Options

Miniature Ribbon and SUPERIBBON products exhibit a degree of self-locking inherent in the contact design; however, additional locking means are recommended to prevent connectors from being unmated inadvertently. Choices include:

- Screwlock Hardware -- the simplest connectors require the use of separate threaded hardware to lock mating connectors together. Some Cinch Miniature Ribbon cable connectors include locking screws; hardware for other configurations may be found in the Accessories section of the Miniature Ribbon line.

Some panel-mount products are available with fixed female (internal thread) screwlocks that provide an integral threaded screwlock as part of the connector.

- Bail Latches -- as an alternative to screwlock hardware, Cinch offers many configurations with industry-standard bail latches. These connectors have wire clips on each end of the socket, and mating plugs have notched ends that these clips snap into.

Bail latches offer the advantage of operating without any tools. Because of this, they have been standardized into several applications, including "Centronics" 36-position parallel printer interface and SCSI-1 peripheral interface bus.

Bail latch sockets include standard "straight" latches, suitable for top entry configurations. Special latches can be ordered to replace one standard latch to fit under the cable on end entry mating plug assemblies.



- InstaLatch™ -- all Cinch SUPERIBBON all-plastic sockets and some metal shell Miniature Ribbon sockets are available with a Cinch-patented latching system called InstaLatch. In this passive latching system, spring clips at each end of the socket automatically lock into windows in the shell of the mating plug securing the two connectors together. Audible feedback confirms that the connectors are indeed locked.

InstaLatches may be unlocked by depressing the latch at either end of the connector, using almost any small, pointed-end tool. A special tool is also available to unlatch InstaLatches when connectors are laid out in a tight arrangement.



- J-Hooks -- These devices, available on selected Miniature Ribbon products, automatically lock onto the nose and hood of mating end entry connectors. They are easily unlatched without special tools and are more accessible than other latches in certain applications.



**Mounting Options**

Various mounting options are available with Cinch Miniature Ribbon and SUPERIBBON products:

- Through-Hole/Threaded Hole -- These products require separate hardware to mount the connector to a panel or other component. Versions are available to accommodate #3, #4, and in some cases, through #8 hardware.

Standard size cutouts are adequate for mounting panel-mount connectors to system panels with this type of hardware. They may be front- or rear-mounted. (Sockets with bail latches, however, must be front-mounted unless a modified cutout is used to clear the latch retaining hardware.)

Metal Shell PC Mount products are available in some versions with standoffs to the printed circuit board. These may be conductive or insulated.



**Standard Panel Cutout Recommendations**



**Dimensions**

**Plug or Fixed-Mount Socket**

**Float-Mount Socket**

| Size | A             | B             | C             | D            | A             | B             | C             | D            |
|------|---------------|---------------|---------------|--------------|---------------|---------------|---------------|--------------|
| 14   | 1.417 (35.99) | 1.098 (27.89) | .940 (23.88)  | .580 (14.73) | 1.417 (35.99) | 1.153 (29.29) | .995 (25.27)  | .635 (16.13) |
| 24   | 1.842 (46.79) | 1.523 (38.68) | 1.365 (34.67) | .580 (14.73) | 1.842 (46.79) | 1.578 (40.08) | 1.420 (36.07) | .635 (16.13) |
| 36   | 2.352 (59.74) | 2.033 (51.64) | 1.875 (47.63) | .580 (14.73) | 2.352 (59.74) | 2.088 (53.04) | 1.930 (49.02) | .635 (16.13) |
| 50   | 2.947 (74.85) | 2.628 (66.75) | 2.472 (62.79) | .580 (14.73) | 2.947 (74.85) | 2.683 (68.15) | 2.525 (64.14) | .635 (16.13) |

**SUPERIBBON, Plug or Socket**

| Size | A             | B             | C             | D            |
|------|---------------|---------------|---------------|--------------|
| 14   | 1.417 (35.99) | 1.172 (29.77) | .787 (19.99)  | .610 (15.49) |
| 24   | 1.842 (46.79) | 1.597 (40.56) | 1.212 (30.78) | .610 (15.49) |
| 36   | 2.352 (59.74) | 2.107 (53.52) | 1.722 (43.74) | .610 (15.49) |
| 50   | 2.947 (74.85) | 2.703 (68.66) | 2.317 (58.85) | .610 (15.49) |
| 64   | 3.592 (91.24) | 3.298 (83.77) | 2.912 (73.96) | .610 (15.49) |

- Panel Clips -- These devices are add-on accessories for All-Plastic products and are available as optional configurations on certain Metal Shell products. They allow you to mount the connector to the system panel without screws, nuts, or spacers, and leave the connector's mounting holes free for use in latching, if so desired.
- Boardlocks -- These devices, found on certain solder-tail PC mount products, fasten the connector to the printed circuit board with solder as part of the wave soldering process. Thus, there is no additional labor required to complete the assembly, and a cost savings can often be realized.



**.085 in. (2.16mm)  
Density  
Miniature Ribbon**

IDC, SUPERIBBON™  
All-Plastic



FEATURES

- *Patented contact terminates Discrete Wire (loose or jacketed cable) without stripping or soldering solid- and stranded-wire versions available.*
- *All-plastic design reduces cost.*
- *Available in plug and socket styles in 14, 24, 36, 50, and 64 position sizes.*
- *Includes InstaLatch passive latch feature for automatic latching. Sockets are also available without latches.*
- *Available with .125" or #4-40 mounting holes. 50-position size plug also available to lock with industry-standard Bail Latches.*
- *Designed for panel mount, 180° (Top-Entry), or 90° (Standard) / 270° (Reverse) End-Entry cable application.*
- *Integral Cable Clamp on End-Entry versions provides superior strain relief, even with hood removed.*
- *Full range of application tooling is available for termination, unlatching, etc. See page 6-54 for details.*
- *UL Recognized - Files E170218 (UL1977), E130965 (UL1863).*
- *CSA Approved - File LR31996-7.*

MATERIALS

**Insulator:** Gray UL94V-0 rated glass-filled polyester, except where noted  
**Contact:** Copper alloy  
**Contact Plating:** select gold over 50µin. select nickel standard;  
 30µin. select gold over 50µin. select nickel available  
 where indicated

ENVIRONMENTAL

**Operating Temperature:** -40°C to +105°C  
**Shock:** 50G Peak, per EIA Std. RS364, TP27, Condition A  
**Vibration:** 3 cycles @ 10-55Hz in each of 3 axes per EIA Std. 364, TP28,  
 Condition A  
**Moisture Resistance:** Per EIA Std. RS364, TP31, Condition B, with Step  
 7B excluded

ELECTRICAL

**Voltage Rating:** 500 VAC @ sea level; 125 VAC @ 70,000 ft.  
**Withstanding Voltage:** 1200 VAC RMS @ sea level, per EIA Std. RS364, TP20  
**Contact Rating:** 5 Amps (4 Amps per CSA)  
**Contact Resistance:** 6 milliohms maximum, per EIA Std. RS364, TP6  
**Contact Resistance Change During Life Conditioning:**

| Wire Size       | Resistance Change<br>(milliohms, max.) |
|-----------------|--|
| 24 AWG Solid    | 0.5                                    |
| 26 AWG Solid    | 0.5                                    |
| 26 AWG Stranded | 2.0                                    |
| 28 AWG Stranded | 5.0                                    |

**Insulation Resistance:** 5000 Megohms minimum initial;  
 1000 Megohms minimum after moisture

**.085 in. (2.16mm)  
Density  
Miniature Ribbon**

IDC, SUPERIBBON™  
All-Plastic



**Mechanical Characteristics**

**Durability:** 200 mating/unmating cycles

**Mating / Unmating Forces:**

| Size | Mating Force (max.)<br>with InstaLatches |       | Unmating Force (min.)<br>without InstaLatches |      |
|------|--|-------|---|------|
|      | Lb.                                      | Kg    | Lb.   | Kg   |
| 14   | 12                                       | 5.44  | 2   | 0.91 |
| 24   | 17                                       | 7.71  | 4   | 1.81 |
| 36   | 23                                       | 10.43 | 6   | 2.72 |
| 50   | 32                                       | 14.52 | 7   | 3.18 |
| 64   | 37                                       | 16.78 | 8   | 3.63 |



**Termination:** Solid IDC versions terminate 22 AWG - 26 AWG solid wire;  
Stranded IDC versions terminate 24 AWG - 28 AWG stranded wire;  
Recommended Wire Insulation: soft PVC, .040" (1.02mm) max. OD

**Wire Grip Strength (using recommended wire type):**

| Wire Size       | Minimum Force |      |
|-----------------|---------------|------|
|                 | Lb.           | Kg   |
| 24 AWG Solid    | 7             | 3.42 |
| 26 AWG Solid    | 5             | 2.44 |
| 26 AWG Stranded | 5             | 2.44 |



**.085 in. (2.16mm)  
Density  
Miniature Ribbon**

IDC, SUPERIBBON™  
All-Plastic



**Panel Mount**

Panel mount connectors provide signal I/O from a panel or system cabinet.

See pages 6-51 thru 6-53 for accessories such as wire restraints, panel clips, mounting screws, and dust covers that make the use of Cinch SUPERIBBON connectors even more cost-effective in panel-mount applications.

**Dimensions**

| Size | A     |       | B     |       | D     |       |
|------|-------|-------|-------|-------|-------|-------|
|      | in    | mm    | in    | mm    | in    | mm    |
| 14   | 1.745 | 44.32 | 1.417 | 35.99 | 0.738 | 18.75 |
| 24   | 2.170 | 55.12 | 1.842 | 46.79 | 1.163 | 29.54 |
| 36   | 2.680 | 68.07 | 2.352 | 59.74 | 1.673 | 42.49 |
| 50   | 3.275 | 83.19 | 2.947 | 74.85 | 2.268 | 57.61 |
| 64   | 3.875 | 98.43 | 3.542 | 89.97 | 2.863 | 72.72 |

**Plug**



**Socket**



**.085 in. (2.16mm)  
Density  
Miniature Ribbon**

IDC, SUPERIBBON™  
All-Plastic



**Ordering Information, Panel Mount**

**Plug, InstaLatching**

| Mount      | Size | Solid Wire  |              |
|------------|------|-------------|--------------|
|            |      | Commercial  | 30Au/Ni      |
| .125 Hole  | 14   | 97-12140-11 | 97-12140-11A |
|            | 24   | 97-12240-11 | 97-12240-11A |
|            | 36   | 97-12360-11 | 97-12360-11A |
|            | 50   | 97-12500-11 | 97-12500-11A |
|            | 64   | 97-12640-11 | 97-12640-11A |
| #4-40 Hole | 14   | 97-12140-01 | 97-12140-01A |
|            | 24   | 97-12240-01 | 97-12240-01A |
|            | 36   | 97-12360-01 | 97-12360-01A |
|            | 50   | 97-12500-01 | 97-12500-01A |
|            | 64   | 97-12640-01 | 97-12640-01A |

**Socket**

| Latch        | Mount      | Size | Solid Wire  |              |
|--------------|------------|------|-------------|--------------|
|              |            |      | Commercial  | 30Au/Ni      |
| InstaLatches | .125 Hole  | 14   | 97-22140-11 | 97-22140-11A |
|              |            | 24   | 97-22240-11 | 97-22240-11A |
|              |            | 36   | 97-22360-11 | 97-22360-11A |
|              |            | 50   | 97-22500-11 | 97-22500-11A |
|              |            | 64   | 97-22640-11 | 97-22640-11A |
|              | #4-40 Hole | 14   | 97-22140-01 | 97-22140-01A |
|              |            | 24   | 97-22240-01 | 97-22240-01A |
|              |            | 36   | 97-22360-01 | 97-22360-01A |
|              |            | 50   | 97-22500-01 | 97-22500-01A |
|              |            | 64   | 97-22640-01 | 97-22640-01A |
| No Latches   | .125 Hole  | 14   | 97-22140-12 | 97-22140-12A |
|              |            | 24   | 97-22240-12 | 97-22240-12A |
|              |            | 36   | 97-22360-12 | 97-22360-12A |
|              |            | 50   | 97-22500-12 | 97-22500-12A |
|              |            | 64   | 97-22640-12 | 97-22640-12A |
|              | #4-40 Hole | 14   | 97-22140-02 | 97-22140-02A |
|              |            | 24   | 97-22240-02 | 97-22240-02A |
|              |            | 36   | 97-22360-02 | 97-22360-02A |
|              |            | 50   | 97-22500-02 | 97-22500-02A |
|              |            | 64   | 97-22640-02 | 97-22640-02A |

**.085 in. (2.16mm)  
Density  
Miniature Ribbon**

IDC, SUPERIBBON™  
All-Plastic



**180° (Top-Entry) Cable**

Snap-on plastic top-entry hoods are available separately to provide strain relief to a cable when one of the mounting/latching options from page 6-9 fits your requirements. See page 6-53 for details and ordering information for top-entry all-plastic hoods.

For bail latching applications, a 50-position size top-entry plug is available. It locks with industry-standard bail latches for positive locking/unlocking without tools. It also locks with InstaLatch latches for passive automatic latching.

For these products, insulator material is blue UL94V-0 rated glass-filled polyester, and hood material is gray UL94V-0 rated glass-filled polyester.



**Ordering Information, 180° (Top-Entry) Cable Bail Latching Plug**

| Size | Solid Wire                  |             |                             |             |
|------|-----------------------------|-------------|-----------------------------|-------------|
|      | Large (.296") Cable Opening |             | Small (.250") Cable Opening |             |
|      | Commercial                  | 30Au/Ni     | Commercial                  | 30Au/Ni     |
| 50   | 77-32500LP                  | 77-32500LPA | 77-32500SP                  | 77-32500SPA |

**90° (Standard) / 270° (Reverse) End-Entry Cable**

End-Entry connectors include a hood and integral cable clamp for cable exit from the end of the connector.

- The standard-orientation plug has the cable clamp on the position-1 end, and the standard-orientation socket has the clamp on the high position end.
- Cables may be extended end-to-end (i.e., "running cable") by mating standard-orientation plugs and sockets, or "doubled back" by mating a standard-orientation connector with a reverse-orientation mate.
- Cables may exit either direction on a cable-to-panel application by choosing standard or reverse-orientation, depending on the desired direction of cable exit.
- Pointed-nose versions of the standard-orientation, 50-position size are slightly smaller than the square-end product and are suited to applications with limited space such as bridging adapters, etc.
- #4-40 versions include screws that are 3/4" long, suitable for locking directly to the body of another connector. For locking to connectors panel-mounted with screwlock hardware, shorter screws are required. See pages 6-51 thru 6-53 for these and other accessories, such as dust covers.



Running Cable Application



Doubled-Back Cable Application



**.085 in. (2.16mm)  
Density  
Miniature Ribbon**

IDC, SUPERIBBON™  
All-Plastic



**Dimensions, Square End**

| Size | A     |        | B     |       |
|------|-------|--------|-------|-------|
|      | in    | mm     | in    | mm    |
| 14   | 2.114 | 53.70  | 1.417 | 35.99 |
| 24   | 2.539 | 64.49  | 1.842 | 46.79 |
| 36   | 3.049 | 77.44  | 2.352 | 59.74 |
| 50   | 3.677 | 93.40  | 2.947 | 74.85 |
| 64   | 4.511 | 114.58 | 3.542 | 89.97 |

**Plug**



**Socket**



**Ordering Information, Square End  
Standard (90°) Orientation**

**Plug, InstaLatching**

| Mount                 | Size | Solid Wire  |              |
|-----------------------|------|-------------|--------------|
|                       |      | Commercial  | 30Au/Ni      |
| .125 Hole             | 14   | 97-12140-90 | 97-12140-90A |
|                       | 24   | 97-12240-90 | 97-12240-90A |
|                       | 36   | 97-12360-90 | 97-12360-90A |
|                       | 50   | 97-12500-90 | 97-12500-90A |
|                       | 64   | 97-12640-90 | 97-12640-90A |
| #4-40 Hole with Screw | 14   | 97-12140-91 | 97-12140-91A |
|                       | 24   | 97-12240-91 | 97-12240-91A |
|                       | 36   | 97-12360-91 | 97-12360-91A |
|                       | 50   | 97-12500-91 | 97-12500-91A |
|                       | 64   | 97-12640-91 | 97-12640-91A |

**Socket**

| Latch        | Mount                 | Size | Solid Wire  |              |
|--------------|-----------------------|------|-------------|--------------|
|              |                       |      | Commercial  | 30Au/Ni      |
| InstaLatches | .125 Hole             | 14   | 97-22140-90 | 97-22140-90A |
|              |                       | 24   | 97-22240-90 | 97-22240-90A |
|              |                       | 36   | 97-22360-90 | 97-22360-90A |
|              |                       | 50   | 97-22500-90 | 97-22500-90A |
|              |                       | 64   | 97-22640-90 | 97-22640-90A |
|              | #4-40 Hole with Screw | 14   | 97-22140-91 | 97-22140-91A |
|              |                       | 24   | 97-22240-91 | 97-22240-91A |
|              |                       | 36   | 97-22360-91 | 97-22360-91A |
|              |                       | 50   | 97-22500-91 | 97-22500-91A |
|              |                       | 64   | 97-22640-91 | 97-22640-91A |
| No Latches   | .125 Hole             | 14   | 97-22140-92 | 97-22140-92A |
|              |                       | 24   | 97-22240-92 | 97-22240-92A |
|              |                       | 36   | 97-22360-92 | 97-22360-92A |
|              |                       | 50   | 97-22500-92 | 97-22500-92A |
|              |                       | 64   | 97-22640-92 | 97-22640-92A |
|              | #4-40 Hole with Screw | 14   | 97-22140-93 | 97-22140-93A |
|              |                       | 24   | 97-22240-93 | 97-22240-93A |
|              |                       | 36   | 97-22360-93 | 97-22360-93A |
|              |                       | 50   | 97-22500-93 | 97-22500-93A |
|              |                       | 64   | 97-22640-93 | 97-22640-93A |

**Ordering Information, Square End (Cont'd)**

**Reverse (270°) Orientation**

**Plug, InstaLatching**

| Mount                    | Size | Solid Wire   |               |
|--------------------------|------|--------------|---------------|
|                          |      | Commercial   | 30Au/Ni       |
| .125 Hole                | 14   | 97-12140-270 | 97-12140-270A |
|                          | 24   | 97-12240-270 | 97-12240-270A |
|                          | 36   | 97-12360-270 | 97-12360-270A |
|                          | 50   | 97-12500-270 | 97-12500-270A |
|                          | 64   | 97-12640-270 | 97-12640-270A |
| #4-40 Hole<br>with Screw | 14   | 97-12140-271 | 97-12140-271A |
|                          | 24   | 97-12240-271 | 97-12240-271A |
|                          | 36   | 97-12360-271 | 97-12360-271A |
|                          | 50   | 97-12500-271 | 97-12500-271A |
|                          | 64   | 97-12640-271 | 97-12640-271A |

**Socket**

| Latch        | Mount                    | Size | Solid Wire   |               |
|--------------|--------------------------|------|--------------|---------------|
|              |                          |      | Commercial   | 30Au/Ni       |
| InstaLatches | .125 Hole                | 14   | 97-22140-270 | 97-22140-270A |
|              |                          | 24   | 97-22240-270 | 97-22240-270A |
|              |                          | 36   | 97-22360-270 | 97-22360-270A |
|              |                          | 50   | 97-22500-270 | 97-22500-270A |
|              |                          | 64   | 97-22640-270 | 97-22640-270A |
|              | #4-40 Hole<br>with Screw | 14   | 97-22140-271 | 97-22140-271A |
|              |                          | 24   | 97-22240-271 | 97-22240-271A |
|              |                          | 36   | 97-22360-271 | 97-22360-271A |
|              |                          | 50   | 97-22500-271 | 97-22500-271A |
|              |                          | 64   | 97-22640-271 | 97-22640-271A |
| No Latches   | .125 Hole                | 14   | 97-22140-272 | 97-22140-272A |
|              |                          | 24   | 97-22240-272 | 97-22240-272A |
|              |                          | 36   | 97-22360-272 | 97-22360-272A |
|              |                          | 50   | 97-22500-272 | 97-22500-272A |
|              |                          | 64   | 97-22640-272 | 97-22640-272A |
|              | #4-40 Hole<br>with Screw | 14   | 97-22140-273 | 97-22140-273A |
|              |                          | 24   | 97-22240-273 | 97-22240-273A |
|              |                          | 36   | 97-22360-273 | 97-22360-273A |
|              |                          | 50   | 97-22500-273 | 97-22500-273A |
|              |                          | 64   | 97-22640-273 | 97-22640-273A |

**.085 in. (2.16mm)  
Density  
Miniature Ribbon**

IDC, SUPERIBBON™  
All-Plastic



**Pointed-End 50-Position 90° End-Entry Cable**



**Ordering Information, Pointed-End**

|                              | <b>Solid Wire</b>                     |                |
|------------------------------|---------------------------------------|----------------|
|                              | <b>#4-40 Threaded Hole with Screw</b> |                |
|                              | <b>Commercial</b>                     | <b>30Au/Ni</b> |
| <b>Plug, InstaLatching</b>   |                                       |                |
| With Dust Cover              | 97-12500-91PD                         | 97-12500-91PDA |
| Without Dust Cover           | 97-12500-91P                          | 97-12500-91PA  |
| <b>Socket, InstaLatching</b> |                                       |                |
| With Dust Cover              | 97-22500-91PD                         | 97-22500-91PDA |
| Without Dust Cover           | 97-22500-91P                          | 97-22500-91PA  |
| <b>Socket, No Latches</b>    |                                       |                |
| With Dust Cover              | 97-22500-93PD                         | 97-22500-93PDA |
| Without Dust Cover           | 97-22500-93P                          | 97-22500-93PA  |

**.085 in. (2.16mm)  
Density  
Miniature Ribbon**

IDC  
Metal Shell



FEATURES

- **Patented contact terminates Discrete Wire (loose or jacketed cable) without stripping or soldering. Solid and stranded wire versions available.**
- **Metal shell provides grounding and shielding capability.**
- **Available in plug and socket styles in 14, 24, 36, and 50 position sizes.**
- **Designed for panel mount, 180° (Top-Entry), or 90° (Standard) / 270° (Reverse) End-Entry cable applications.**
- **Available as overmold kit in 36 and 50 position sizes.**
- **All Plugs lock with InstaLatch passive latch feature for automatic latching. Sockets available with InstaLatches where indicated.**
- **Industry-standard bail latch feature available for locking/unlocking without tools in applications such as SCSI-1 and Centronics.**
- **Full range of application tooling available for termination, unlatching, etc. See page 6-54 for details.**
- **UL Recognized - Files E170218 (UL1977), E130965 (UL1863).**
- **CSA Approved - File LR31996-7.**

MATERIALS

**Insulator:** Blue UL94V-0 rated glass-filled polyester  
**Contact:** Copper alloy  
**Contact Plating:** Select gold over 50µin. select nickel standard;  
 30µin. select gold over 50µin. select nickel available  
 where indicated  
**Shell:** Steel  
**Shell Plating:** Zinc with clear chromate coating standard  
 Tin available where indicated

ENVIRONMENTAL

**Operating Temperature:** -40°C to +105°C  
**Shock:** 50G Peak, per EIA Std. RS364, TP27, Condition A  
**Vibration:** 3 cycles @ 10-55Hz in each of 3 axes per EIA Std. 364, TP28,  
 Condition A  
**Moisture Resistance:** Per EIA Std. RS364, TP31, Condition B, with Step  
 7B excluded

ELECTRICAL

**Voltage Rating:** 500 VAC @ sea level; 125 VAC @ 70,000 ft.  
**Withstanding Voltage:** 1200 VAC RMS @ sea level, per EIA Std.  
 RS364, TP20  
**Contact Rating:** 5 Amps (4 Amps per CSA)  
**Contact Resistance:** 6 milliohms maximum, per EIA Std. RS364, TP6  
**Contact Resistance Change During Life Conditioning:**

| Wire Size       | Resistance Change<br>(milliohms, max.) |
|-----------------|--|
| 24 AWG Solid    | 0.5                                    |
| 26 AWG Solid    | 0.5                                    |
| 26 AWG Stranded | 2.0                                    |
| 28 AWG Stranded | 5.0                                    |

**Insulation Resistance:** 5000 Megohms minimum initial;  
 1000 Megohms minimum after moisture

**.085 in. (2.16mm)  
Density  
Miniature Ribbon**

IDC  
Metal Shell



**Mechanical Characteristics**

**Durability:** 200 mating/unmating cycles

**Mating / Unmating Forces:**



| Size | Mating Force (max.)<br>with InstaLatches |       | Unmating Force (min.)<br>without InstaLatches |      |
|------|--|-------|---|------|
|      | Lb.                                      | Kg    | Lb.   | Kg   |
| 14   | 12                                       | 5.44  | 2   | 0.91 |
| 24   | 17                                       | 7.71  | 4   | 1.81 |
| 36   | 23                                       | 10.43 | 6   | 2.72 |
| 50   | 32                                       | 14.52 | 7   | 3.18 |

**Termination:** Solid IDC versions terminate 22 AWG - 26 AWG solid wire; Stranded IDC versions terminate 24 AWG - 28 AWG stranded wire; Recommended Wire Insulation: soft PVC, .040" (1.02mm) max. OD



**Wire Grip Strength (using recommended wire type):**

| Wire Size       | Min. Force |      |
|-----------------|------------|------|
|                 | Lb.        | Kg   |
| 24 AWG Solid    | 7          | 3.42 |
| 26 AWG Solid    | 5          | 2.44 |
| 26 AWG Stranded | 5          | 2.44 |



**.085 in. (2.16mm)  
Density  
Miniature Ribbon**

IDC  
Metal Shell



**Panel Mount**

“Panel mount” products are connectors without hoods. They are typically used to provide signal I/O from a system panel or cabinet, where strain relief to a cable jacket is not required.

- Standard versions have .103" mounting holes (sockets have .103" with float bushings) for use with #3 hardware, or with .185" mounting holes for use with #8 hardware.
- Select sizes are available with .120" or .113" mounting holes for use with #4 hardware, or with integral panel clips, which allow snap-in front mounting on .093" thick panels for more cost-effective assembly.
- Bail latching sockets are available, as are bail latching plugs. While the plugs would not be panel-mounted, they are available for premold/solder overmolding applications.
- SuperShield products include modified shells that assure interference fit between mated connectors for improved shielding performance.

See page 6-4 for recommended standard panel cutout dimensions.

See pages 6-51 thru 6-52 for accessories such as wire restraints, mounting screws, and dust covers, which make the use of Cinch Miniature Ribbon connectors even more cost-effective in panel-mount applications.

See the appropriate cable connector section that follows for products that include hoods for exposed-cable applications.

**Dimensions**

| Size | A     |       | B     |       | C     |       | D     |       |
|------|-------|-------|-------|-------|-------|-------|-------|-------|
|      | in    | mm    | in    | mm    | in    | mm    | in    | mm    |
| 14   | 1.750 | 44.45 | 1.417 | 35.99 | 0.910 | 23.11 | -     | -     |
| 24   | 2.175 | 55.25 | 1.842 | 46.79 | 1.335 | 33.91 | -     | -     |
| 36   | 2.685 | 68.20 | 2.352 | 59.74 | 1.845 | 46.86 | 2.426 | 61.62 |
| 50   | 3.280 | 83.31 | 2.947 | 74.85 | 2.440 | 61.98 | 3.020 | 76.71 |

**Plug**



**Socket**



**.085 in. (2.16mm)  
Density  
Miniature Ribbon**

IDC  
Metal Shell



**Ordering Information, Panel Mount**

**Plug, InstaLatching**

| Mount                          | Size | Solid Wire   |               |
|--------------------------------|------|--------------|---------------|
|                                |      | Commercial   | 30Au/Ni       |
| .103 Hole                      | 14   | 77-12140     | 77-12140A     |
|                                | 24   | 77-12240     | 77-12240A     |
|                                | 36   | 77-12360     | 77-12360A     |
|                                | 50   | 77-12500     | 77-12500A     |
| .103 Hole<br>Tin-Plated Shells | 24   | 77-12240-32  | 77-12240-32A  |
|                                | 36   | 77-12360-32  | 77-12360-32A  |
|                                | 50   | 77-12500-32  | 77-12500-32A  |
| .185 Hole                      | 14   | 77-12140-185 | 77-12140-185A |
|                                | 24   | 77-12240-185 | 77-12240-185A |
|                                | 36   | 77-12360-185 | 77-12360-185A |
|                                | 50   | 77-12500-185 | 77-12500-185A |
| .185 Hole<br>Tin-Plated Shells | 24   | 77-12240-186 | 77-12240-186A |
|                                | 36   | 77-12360-186 | 77-12360-186A |
|                                | 50   | 77-12500-186 | 77-12500-186A |
| .120 Hole                      | 50   | 77-12500-120 | 77-12500-120A |
| .120 Hole, Tin-Plated Shells   | 50   | 77-12500-121 | 77-12500-121A |
| SuperShield, .133 Hole         | 50   | 77-12500-SH  | 77-12500-SHA  |
| Bail Latching                  | 36   | 77-12360-5   | 77-12360-5A   |
| Tin-Plated Shells              | 50   | 77-12500-10  | 77-12500-10A  |
| .103 Hole                      | 50   | 77-12500-41  | 77-12500-41A  |
| Fixed 4-40 Screwlock           | 50   | 77-12500-43  | 77-12500-43A  |
| SuperShield, .103 Hole         | 50   | 77-12500-SC  | 77-12500-SCA  |

\* Integral Panel Clips

\*Integral Panel Clips, for front-mount only, require modified panel cutout. See page 6-52 for details.

**Through Hole**



**Bail Latching**

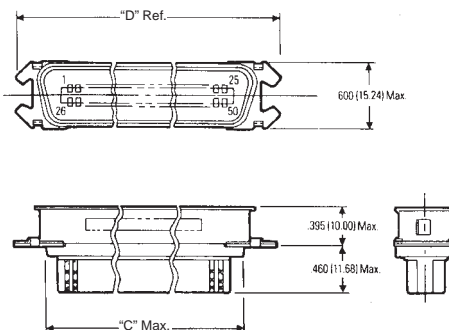

**Integral Panel Clip**



**.085 in. (2.16mm)  
Density  
Miniature Ribbon**

IDC  
Metal Shell



**Ordering Information, Panel Mount (Cont'd)**

| Socket   |  | Solid Wire   |               |              |
|--|--|--------------|---------------|--------------|
| Mount  | Size   | Commercial   | 30Au/Ni       |              |
| Float Mounts with<br>.103 Hole                 | 14   | 77-22140     | 77-22140A     |              |
|  | 24   | 77-22240     | 77-22240A     |              |
|  | 36   | 77-22360     | 77-22360A     |              |
|  | 50   | 77-22500     | 77-22500A     |              |
| .103 Hole<br>Tin-Plated Shells                 | 24   | 77-22240-34  | 77-22240-34A  |              |
|  | 36   | 77-22360-34  | 77-22360-34A  |              |
|  | 50   | 77-22500-34  | 77-22500-34A  |              |
| No Latches<br>.185 Hole                        | 14   | 77-22140-185 | 77-22140-185A |              |
|  | 24   | 77-22240-185 | 77-22240-185A |              |
|  | 36   | 77-22360-185 | 77-22360-185A |              |
|  | 50   | 77-22500-185 | 77-22500-185A |              |
| .185 Hole<br>Tin-Plated Shells                 | 24   | 77-22240-186 | 77-22240-186A |              |
|  | 36   | 77-22360-186 | 77-22360-186A |              |
|  | 50   | 77-22500-186 | 77-22500-186A |              |
| .120 Hole                                      | 50   | 77-22500-120 | 77-22500-120A |              |
| Integral Panel Clips*, .103 Hole               | 50   | 77-22500-41  | 77-22500-41A  |              |
| Integral Panel Clips*<br>Fixed 4-40 Screwlocks | 50   | 77-22500-43  | 77-22500-43A  |              |
| Bail Latches<br>.116 Hole                      | 14   | 77-42140     | 77-42140A     |              |
|  | 24   | 77-42240     | 77-42240A     |              |
|  | 36   | 77-42360     | 77-42360A     |              |
|  | 50   | 77-42500     | 77-42500A     |              |
| .116 Hole with<br>Tin-Plated Shell             | 36   | 77-42360-5   | 77-42360-5A   |              |
|  | 50   | 77-42500-5   | 77-42500-5A   |              |
| Instalatches<br>.103 Hole<br>Tin-Plated Shell  | 50   | 77-22500-36  | 77-22500-36A  |              |
|  | .113 Hole<br>Tin-Plated Shell                        | 50           | 77-22500-38   | 77-22500-38A |
|  | SuperShield, .103 Hole with<br>Integral Panel Clips* | 50           | 77-22500-SC   | 77-22500-SCA |

\* Integral Panel Clips, for front-mount only, require modified panel cutout.  
See page 6-52 for details.

**Through Hole**



**Bail Latching**



**Float Mount**





**.085 in. (2.16mm)  
Density  
Miniature Ribbon**

IDC  
Metal Shell



**180° (Top-Entry) Cable**

Top-Entry products include a connector, hood (or overmold can), and associated hardware.

They are typically used at the end of a cable, where it is subject to physical strain and protection of the termination area is required.

- Includes all hardware required to attach hood to connector.
- Bail latching sockets have latch hardware integral to the connector body, making cable assembly more efficient.
- Bail latching plugs include notches that lock with industry-standard bail-latch sockets.
- Select configurations are available as overmold kits, which lower assembly costs by eliminating premolding and foil soldering. Kits include connector and overmold cans. Crimp ferrules, which ground cable shields and provide strain relief, must be ordered separately.
- Ordering information for crimp ferrules is at end of end-entry product section. See page 6-22.

**Plug**



**Socket**



**Overmold Kit**

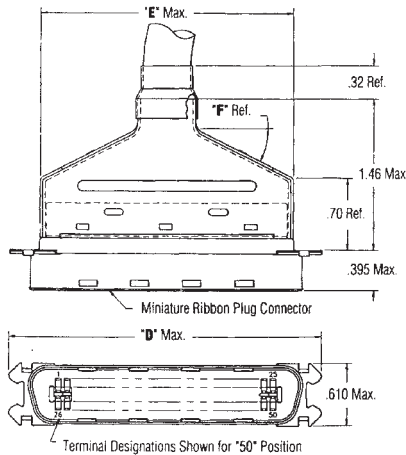

**Dimensions**

| Size | A     |       | B     |       | C    |       | D     |       | E    |       | F    | G    |       | H    |       | M   |       |
|------|-------|-------|-------|-------|------|-------|-------|-------|------|-------|------|------|-------|------|-------|-----|-------|
|      | in    | mm    | in    | mm    | in   | mm    | in    | mm    | in   | mm    | Deg. | in   | mm    | in   | mm    | in  | mm    |
| 14   | 1.417 | 35.99 | 1.750 | 44.45 | .306 | 7.77  | 1.495 | 37.97 | -    | -     | -    | .422 | 10.72 | .843 | 21.41 | -   | -     |
| 24   | 1.842 | 46.79 | 2.175 | 55.25 | .473 | 11.10 | 1.920 | 48.77 | -    | -     | -    | .473 | 12.01 | .825 | 20.96 | -   | -     |
| 36   | 2.352 | 59.74 | 2.685 | 68.20 | .639 | 16.23 | 2.431 | 61.75 | 1.83 | 46.48 | 37°  | .473 | 12.01 | .905 | 22.99 | .52 | 13.21 |
| 50   | 2.947 | 74.85 | 3.270 | 83.06 | .766 | 19.46 | 3.025 | 76.84 | 2.43 | 61.72 | 27°  | .473 | 12.01 | .995 | 25.27 | .60 | 15.24 |

**.085 in. (2.16mm)  
Density  
Miniature Ribbon**

IDC  
Metal Shell



**Ordering Information, 180° (Top-Entry) Cable**

**Plug, InstaLatching**

| Mount               | Size                 | Solid Wire  |              |              |
|---------------------|----------------------|-------------|--------------|--------------|
|                     |                      | Commercial  | 30Au/Ni      |              |
| Bail Latching       | 14                   | 77-32140    | 77-32140A    |              |
|                     | 24                   | 77-32240    | 77-32240A    |              |
|                     | 36                   | 77-32360    | 77-32360A    |              |
|                     | 50                   | 77-32500    | 77-32500A    |              |
| Captive 4-40 Screws | 50                   | 77-32500-30 | 77-32500-30A |              |
| Overmold kit        | Bail Latching,       | 36          | 77-32360-51  | 77-32360-51A |
|                     | Tin Shell            | 50          | 77-32500-51  | 77-32500-51A |
|                     | .103 Hole, Tin Shell | 36          | 77-32360-52  | 77-32360-52A |
|                     |                      | 50          | 77-32500-52  | 77-32500-52A |

**Socket**

| Mount                      | Size                            | Solid Wire |             |              |
|----------------------------|---------------------------------|------------|-------------|--------------|
|                            |                                 | Commercial | 30Au/Ni     |              |
| With Bail Latches          | 14                              | 77-62140   | 77-62140A   |              |
|                            | 24                              | 77-62240   | 77-62240A   |              |
|                            | 36                              | 77-62360   | 77-62360A   |              |
|                            | 50                              | 77-62500   | 77-62500A   |              |
| Overmold kit<br>InstaLatch | .103 Hole,<br>Tin-Plated Shells | 50         | 77-62500-54 | 77-62500-54A |
|                            | .113 Hole,<br>Tin-Plated Shells | 50         | 77-62500-55 | 77-62500-55A |

**.085 in. (2.16mm)  
Density  
Miniature Ribbon**

IDC  
Metal Shell



**90° (Standard) / 270° (Reverse) End-Entry Cable**

End-Entry connectors, available in 50 position size only, include a hood and integral cable clamp for cable exit from the end of the connector.

- The standard-orientation plug has the cable clamp on the position 1/26 end, and the standard-orientation socket has the clamp on the position 25/50 end.
- Cables may be extended end-to-end (i.e., “running cable”) by mating standard-orientation plugs and sockets, or “doubled back” by mating a standard-orientation connector with a reverse-orientation mate.
- Cables may exit either direction on a cable-to-panel application by choosing standard or reverse-orientation, depending on the desired direction of cable exit.
- Include screw that is 5/8" long, suitable for locking directly to the body of another connector. For locking to connectors panel-mounted with screwlock hardware, shorter screws are required. See page 6-51 for these and other accessories, such as dust covers.



Running Cable Application



Double-Back Cable Application

**Low Hood**



**High Hood**



**Ordering Information, End-Entry**

**Standard (90°) Orientation**

|                      | Mount                   | Size | Solid Wire  |              |
|----------------------|-------------------------|------|-------------|--------------|
|                      |                         |      | Commercial  | 30Au/Ni      |
| Plug                 | High (Standard) Hood    | 50   | 77-72500    | 77-72500A    |
|                      | Low-Profile Hood        | 50   | 77-72500-1  | 77-72500-1A  |
|                      | SuperShield, 4-40 Screw | 50   | 77-72500-SS | 77-72500-SSA |
| Socket<br>no latches | High (Standard) Hood    | 50   | 77-82500    | 77-82500A    |
|                      | Low-Profile Hood        | 50   | 77-82500-1  | 77-82500-1A  |
|                      | SuperShield, 4-40 Screw | 50   | 77-82500-SS | 77-82500-SSA |

**Reverse (270°) Orientation**

|                   | Mount                | Size | Solid Wire   |               |
|-------------------|----------------------|------|--------------|---------------|
|                   |                      |      | Commercial   | 30Au/Ni       |
| Plug              | High (Standard) Hood | 50   | 77-72500-270 | 77-72500-270A |
|                   | Low-Profile Hood     | 50   | 77-72500-271 | 77-72500-271A |
| Socket<br>latches | High (Standard) Hood | 50   | 77-82500-270 | 77-82500-270A |
|                   | Low-Profile Hood     | 50   | 77-82500-271 | 77-82500-271A |

**.085 in. (2.16mm)  
Density  
Miniature Ribbon**

IDC  
Metal Shell



**Overmold Kit, End-Entry  
(May be assembled with cable exit in either direction)**



**Ordering Information, End-Entry Overmold Kit**

|                         |                                | Solid Wire |             |              |
|-------------------------|--------------------------------|------------|-------------|--------------|
|                         |                                | Size       | Commercial  | 30Au/Ni      |
| Socket<br>Install/Latch | Plug, Bail Latching, Tin Shell | 50         | 77-72500-51 | 77-72500-51A |
|                         | .103 Hole, Tin-Plated Shells   | 50         | 77-82500-54 | 77-82500-54A |
|                         | .113 Hole, Tin-Plated Shells   | 50         | 77-82500-55 | 77-82500-55A |

**Overmold Crimp Ferrules**

- Connect cable's shield to can of overmold kit
- Seal off cable exit to keep molding compound from penetrating termination cavity

See page 6-56 for tools and dies required to crimp ferrules onto overmold cans.

**Ordering Information, Overmold Crimp Ferrules**

| Kit<br>Size | Max. Cable O.D. | Ferrule<br>Part Number | Dimensions   |              |
|-------------|-----------------|------------------------|--------------|--------------|
|             |                 |                        | G            | H            |
| 36          | 0.400           | CF-64                  | .480 (12.19) | .400 (10.16) |
| 50          | 0.390           | CF-60                  | .580 (14.73) | .390 (9.91)  |
|             | 0.480           | CF-57                  | .580 (14.73) | .480 (12.19) |

**Ferrule**



**.085 in. (2.16mm)  
Density  
Miniature Ribbon**

Solder Cup  
Metal Shell



FEATURES

- Terminates Discrete Wire (loose or jacketed cable) with ultra-low-resistance solder connections.
- Metal shell provides grounding and shielding capability.
- Available in plug and socket styles in 14, 24, 36, and 50 position sizes.
- Designed for panel mount, 180° (Top-Entry), or 90° (Standard) / 270° (Reverse) End-Entry cable applications.
- All plugs lock with InstaLatch passive latch feature for automatic latching.
- Industry-standard bail latch feature available for locking/unlocking without tools in applications such as SCSI-1 and Centronics.
- UL Recognized - Files E170218 (UL1977), E130965 (UL1863).
- CSA Approved - File LR31996-7.

MATERIALS

**Insulator:** Blue UL94V-0 rated diallyl phthalate type MDG, per MIL-M14F  
**Contact:** Copper alloy  
**Contact Plating:** Select gold over 50µin. select nickel standard;  
 30µin. select gold over 50µin. select nickel available where indicated  
**Shell:** Steel  
**Shell Plating:** Zinc with clear chromate coating



ENVIRONMENTAL

**Operating Temperature:** -40°C to +105°C  
**Shock:** 50G Peak, per EIA Std. RS364, TP27, Condition A  
**Vibration:** 3 cycles @ 10-55Hz in each of 3 axes per EIA Std. 364, TP28, Condition A  
**Moisture Resistance:** Per EIA Std. RS364, TP31, Condition B, with Step 7B excluded



ELECTRICAL

**Voltage Rating:** 500 VAC @ sea level; 125 VAC @ 70,000 ft.  
**Withstanding Voltage:** 1200 VAC RMS @ sea level, per EIA Std. RS364, TP20  
**Contact Rating:** 5 Amps (4 Amps per CSA)  
**Contact Resistance:** 6 Milliohms maximum, per EIA Std. RS364, TP6  
**Insulation Resistance:** 5000 Megohms minimum initial;  
 1000 Megohms minimum after moisture



MECHANICAL

**Durability:** 200 mating/unmating cycles  
**Mating / Unmating Forces:**

| Size | Mating Force (max.) |      | Unmating Force (min.) |      |
|------|---------------------|------|-----------------------|------|
|      | Lb.                 | Kg   | Lb.                   | Kg   |
| 14   | 5                   | 2.27 | 2                     | 0.91 |
| 24   | 8                   | 3.63 | 4                     | 1.81 |
| 36   | 12                  | 5.44 | 6                     | 2.72 |
| 50   | 15                  | 6.80 | 7                     | 3.18 |

**Termination:** Each contact accepts maximum 22 AWG solid wire or maximum 24 AWG stranded wire



# .085 in. (2.16mm) Density Miniature Ribbon

Solder Cup  
Metal Shell



## Panel Mount

"Panel mount" products are connectors without hoods. They are typically used to provide signal I/O from a system panel or cabinet, where strain relief to a cable jacket is not required.

- Available with high barrier insulators that extend beyond the end of the solder cup, physically isolating adjacent contacts.
- Standard versions have .103" mounting holes (sockets have .103" with float bushings) for use with #3 hardware, or .185" mounting holes for use with #8 hardware.
- Select sizes are available with .120" mounting holes for use with #4 hardware, or with integral panel clips, which allow snap-in front mounting for more cost-effective assembly.
- Bail latching sockets are available, as are bail latching plugs. While the plugs would not be panel-mounted, they are available for premold/solder overmolding applications.

See page 6-4 for recommended standard panel cutout dimensions.

See page 6-51 for accessories such as mounting screws and dust covers, which make the use of Cinch Miniature Ribbon connectors even more cost-effective in panel-mount applications.

See the appropriate cable connector section that follows for products that include hoods for exposed-cable applications.

## Dimensions

| Size | A     |       | B     |       | C     |       |
|------|-------|-------|-------|-------|-------|-------|
|      | in    | mm    | in    | mm    | in    | mm    |
| 14   | 1.750 | 44.45 | 1.417 | 35.99 | 0.910 | 23.11 |
| 24   | 2.175 | 55.25 | 1.842 | 46.79 | 1.335 | 33.91 |
| 36   | 2.685 | 68.20 | 2.352 | 59.74 | 1.845 | 46.86 |
| 50   | 3.260 | 82.80 | 2.947 | 74.85 | 2.440 | 61.98 |



**.085 in. (2.16mm)  
Density  
Miniature Ribbon**

Solder Cup  
Metal Shell



**Through Hole**



**Bail Latches**



**Integral Panel Clips**



**Float Mounts**



**Ordering Information, Panel Mount**

**Plug, InstaLatching**

| Mount                            | Size | No Barrier   |               | High Barrier |               |
|----------------------------------|------|--------------|---------------|--------------|---------------|
|                                  |      | Commercial   | 30Au/Ni       | Commercial   | 30Au/Ni       |
| .103 Hole                        | 14   | 57-10140     | 57-10140A     | 57-10140-6   | 57-10140-6A   |
|                                  | 24   | 57-10240     | 57-10240A     | 57-10240-6   | 57-10240-6A   |
|                                  | 36   | 57-10360     | 57-10360A     | 57-10360-14  | 57-10360-14A  |
|                                  | 50   | 57-10500     | 57-10500A     | 57-10500-6   | 57-10500-6A   |
| .185 Hole                        | 14   | 57-10140-185 | 57-10140-185A | -            | -             |
|                                  | 24   | 57-10240-4   | 57-10240-4A   | -            | -             |
|                                  | 36   | 57-10360-22  | 57-10360-22A  | -            | -             |
|                                  | 50   | 57-10500-48  | 57-10500-48A  | -            | -             |
| .120 Hole                        | 50   | -            | -             | 57-10500-120 | 57-10500-120A |
| Integral Panel Clips*, .103 Hole | 50   | -            | -             | 57-10500-41  | 57-10500-41A  |
| Bail Latching                    | 36   | -            | -             | 57-10360-28† | 57-10360-28A† |
| Tin-Plated Shells                | 50   | -            | -             | 57-10500-79  | 57-10500-79A  |

† IEEE 1284-B (for foil wrap & overmold applications)

**Socket**

| Latch        | Mount                            | Size | No Barrier  |              | High Barrier |               |
|--------------|----------------------------------|------|-------------|--------------|--------------|---------------|
|              |                                  |      | Commercial  | 30Au/Ni      | Commercial   | 30Au/Ni       |
| No latches   | Float Mounts with .103 Hole      | 14   | 57-20140    | 57-20140A    | 57-20140-6   | 57-20140-6A   |
|              |                                  | 24   | 57-20240    | 57-20240A    | 57-20240-6   | 57-20240-6A   |
|              |                                  | 36   | 57-20360    | 57-20360A    | 57-20360-10  | 57-20360-10A  |
|              |                                  | 50   | 57-20500    | 57-20500A    | 57-20500-6   | 57-20500-6A   |
|              | .185 Hole                        | 14   | 57-20140-4  | 57-20140-4A  | -            | -             |
|              |                                  | 24   | 57-20240-2  | 57-20240-2A  | -            | -             |
|              |                                  | 36   | 57-20360-3  | 57-20360-3A  | -            | -             |
|              |                                  | 50   | 57-20500-15 | 57-20500-15A | -            | -             |
|              | .120 Hole                        | 50   | -           | -            | 57-20500-120 | 57-20500-120A |
|              | Integral Panel Clips*, .103 Hole | 50   | -           | -            | 57-20500-41  | 57-20500-41A  |
| Bail latches | .116 Hole                        | 14   | 57-40140    | 57-40140A    | 57-40140-HB  | 57-40140-HBA  |
|              |                                  | 24   | 57-40240    | 57-40240A    | 57-40240-HB  | 57-40240-HBA  |
|              |                                  | 36   | 57-40360†   | 57-40360A†   | 57-40360-9†  | 57-40360-9A†  |
|              |                                  | 50   | 57-40500    | 57-40500A    | 57-40500-4   | 57-40500-4A   |
|              | .116 Hole with Tin-Plated Shell  | 50   | 57-40500-5  | 57-40500-5A  | 57-40500-28† | 57-40500-28A† |

\* Integral Panel Clips, for front-mount only, require modified panel cutout. See page 6-52 for details.

† IEEE 1284-B

**.085 in. (2.16mm)  
Density  
Miniature Ribbon**

Solder Cup  
Metal Shell



**180° (Top-Entry) Cable**

Top-Entry products include a connector, hood, and associated hardware. They are typically used at the end of a cable, where it is subject to physical strain and protection of the termination area is required.

- Includes all hardware required to attach hood to connector.
- Bail latching sockets have latch hardware integral to connector body, making cable assembly less costly.
- Bail latching plugs include notches that lock with industry-standard bail-lock sockets.

**Plug**



**Socket**



**Dimensions**

| Size | A     |       | B     |       | C    |       | D     |       | E    |       | F    |       | G    |       |
|------|-------|-------|-------|-------|------|-------|-------|-------|------|-------|------|-------|------|-------|
|      | in    | mm    | in    | mm    | in   | mm    | in    | mm    | in   | mm    | in   | mm    | in   | mm    |
| 14   | 1.417 | 35.99 | 1.750 | 44.45 | .306 | 7.77  | 1.495 | 37.97 | .843 | 21.41 | .306 | 7.77  | .422 | 10.72 |
| 24   | 1.842 | 46.79 | 2.175 | 55.25 | .473 | 11.10 | 1.920 | 48.77 | .825 | 20.96 | .473 | 12.01 | .473 | 12.01 |
| 36   | 2.352 | 59.74 | 2.685 | 68.20 | .639 | 16.23 | 2.431 | 61.75 | .905 | 22.99 | .640 | 16.26 | .473 | 12.01 |
| 50   | 2.947 | 74.85 | 3.270 | 83.06 | .766 | 19.46 | 3.025 | 76.84 | .995 | 25.27 | .766 | 19.46 | .473 | 12.01 |

**Ordering Information, 180° (Top-Entry) Cable**

**Plug, InstaLatching**

| Mount                         | Size | No Barrier |             | High Barrier |             |
|-------------------------------|------|------------|-------------|--------------|-------------|
|                               |      | Commercial | 30Au/Ni     | Commercial   | 30Au/Ni     |
| Bail Latching                 | 14   | 57-30140   | 57-30140A   | -            | -           |
|                               | 24   | 57-30240   | 57-30240A   | -            | -           |
|                               | 36   | 57-30360   | 57-30360A   | -            | -           |
|                               | 50   | 57-30500   | 57-30500A   | 57-30500-3   | 57-30500-3A |
| #4-40 Holes for captive screw | 50   | 57-30500-4 | 57-30500-4A | -            | -           |

**Socket**

| Mount             | Size | No Barrier |           | High Barrier |         |
|-------------------|------|------------|-----------|--------------|---------|
|                   |      | Commercial | 30Au/Ni   | Commercial   | 30Au/Ni |
| With Bail Latches | 14   | 57-60140   | 57-60140A | -            | -       |
|                   | 24   | 57-60240   | 57-60240A | -            | -       |
|                   | 36   | 57-60360   | 57-60360A | -            | -       |
|                   | 50   | 57-60500   | 57-60500A | -            | -       |



**.085 in. (2.16mm)  
Density  
Miniature Ribbon**

Solder Cup  
Metal Shell



**90° (Standard) / 270° (Reverse) End-Entry Cable**

End-Entry connectors, available in 50 position size only, include a hood and integral cable clamp for cable exit from the end of the connector

- The standard-orientation plug has the cable clamp on the position 1/26 end, and the standard-orientation socket has the clamp on the position 25/50 end.
- Cables may be extended end-to-end (i.e., “running cable”) by mating standard-orientation plugs and sockets, or “doubled back” by mating a standard-orientation connector with a reverse-orientation mate.
- Cables may exit either direction on a cable-to-panel application by choosing standard- or reverse-orientation, depending on the desired direction of cable exit.
- Include screw that is 5/8" long, suitable for locking directly to the body of another connector. For locking to connectors panel-mounted with screw-lock hardware, shorter screws are required. See page 6-51 for these and other accessories, such as dust covers.



Running Cable Application



Double-Back Cable Application

Low Hood



High Hood



**Ordering Information, End-Entry**

**Plug, InstaLatching (High Barrier, with Dust Cover)**

| Mount                | Size | Standard (90°) Orientation |              | Reverse (270°) Orientation |               |
|----------------------|------|----------------------------|--------------|----------------------------|---------------|
|                      |      | Commercial                 | 30Au/Ni      | Commercial                 | 30Au/Ni       |
| High (Standard) Hood | 50   | 57-10500-14                | 57-10500-14A | 57-10500-270               | 57-10500-270A |
| Low-Profile Hood     | 50   | 57-10500-7                 | 57-10500-7A  | 57-10500-271               | 57-10500-271A |

**Socket (High Barrier, with Dust Cover)**

| Mount                | Size | Standard (90°) Orientation |              | Reverse (270°) Orientation |               |
|----------------------|------|----------------------------|--------------|----------------------------|---------------|
|                      |      | Commercial                 | 30Au/Ni      | Commercial                 | 30Au/Ni       |
| High (Standard) Hood | 50   | 57-20500-7                 | 57-20500-7A  | 57-20500-270               | 57-20500-270A |
| Low-Profile Hood     | 50   | 57-20500-19                | 57-20500-19A | 57-20500-271               | 57-20500-271A |



# .085 in. (2.16mm) Density Miniature Ribbon

Wire Wrap  
Metal Shell and All-Plastic



## Metal Shell

- Metal Shell Wire Wrap connectors are available with .025" sq. or .045" sq. x 1.35" (.56" wrap length) terminals. .045" sq. terminals are also available with .850" (.28" wrap length) terminals.
- Available with .103" mounting holes for #3 hardware. Sockets also available with bail latches and .116" holes.

See page 6-4 for recommended standard panel cutout dimensions.

See page 6-51 for accessories such as mounting screws, bent bail latches, and dust covers, which make the use of Cinch Miniature Ribbon connectors even more cost-effective.



Bail Latches

## Dimensions

| Sizes | A     |       | B     |       | C     |       | D     |       |
|-------|-------|-------|-------|-------|-------|-------|-------|-------|
|       | in    | mm    | in    | mm    | in    | mm    | in    | mm    |
| 14    | 1.750 | 44.45 | 1.417 | 35.99 | 0.710 | 18.03 | 0.510 | 12.95 |
| 24    | 2.175 | 55.25 | 1.842 | 46.79 | 1.135 | 28.83 | 0.935 | 23.75 |
| 36    | 2.665 | 67.69 | 2.352 | 59.74 | 1.645 | 41.78 | 1.445 | 36.70 |
| 50    | 3.260 | 82.80 | 2.947 | 74.85 | 2.240 | 56.90 | 2.040 | 51.82 |

Metal Plug



Metal Socket



## Ordering Information, Metal Shell

### Plug, InstaLatching

|           | Size | .025" sq. x 1.35" Terminals |               | .045" sq. x 1.35" Terminals |               | .045" sq. x .85" Terminals |               |
|-----------|------|-----------------------------|---------------|-----------------------------|---------------|----------------------------|---------------|
|           |      | Commercial                  | 30Au/Ni       | Commercial                  | 30Au/Ni       | Commercial                 | 30Au/Ni       |
| .103 Hole | 14   | 57-10140-WW1                | 57-10140-WW1A | 57-10140-WW2                | 57-10140-WW2A | 57-10140-WW3               | 57-10140-WW3A |
|           | 24   | 57-10240-WW1                | 57-10240-WW1A | 57-10240-WW2                | 57-10240-WW2A | 57-10240-WW3               | 57-10240-WW3A |
|           | 36   | 57-10360-WW1                | 57-10360-WW1A | 57-10360-WW2                | 57-10360-WW2A | 57-10360-WW3               | 57-10360-WW3A |
|           | 50   | 57-10500-WW1                | 57-10500-WW1A | 57-10500-WW2                | 57-10500-WW2A | 57-10500-WW3               | 57-10500-WW3A |

### Socket

|                         | Size | .025" sq. x 1.35" Terminals |               | .045" sq. x 1.35" Terminals |               | .045" sq. x .85" Terminals |               |
|-------------------------|------|-----------------------------|---------------|-----------------------------|---------------|----------------------------|---------------|
|                         |      | Commercial                  | 30Au/Ni       | Commercial                  | 30Au/Ni       | Commercial                 | 30Au/Ni       |
| .103 Hole               | 14   | 57-20140-WW1                | 57-20140-WW1A | 57-20140-WW2                | 57-20140-WW2A | 57-20140-WW3               | 57-20140-WW3A |
|                         | 24   | 57-20240-WW1                | 57-20240-WW1A | 57-20240-WW2                | 57-20240-WW2A | 57-20240-WW3               | 57-20240-WW3A |
|                         | 36   | 57-20360-WW1                | 57-20360-WW1A | 57-20360-WW2                | 57-20360-WW2A | 57-20360-WW3               | 57-20360-WW3A |
|                         | 50   | 57-20500-WW1                | 57-20500-WW1A | 57-20500-WW2                | 57-20500-WW2A | 57-20500-WW3               | 57-20500-WW3A |
| Bail Latches, .116 Hole | 14   | 57-20140-WW4                | 57-20140-WW4A | -                           | -             | -                          | -             |
|                         | 24   | 57-20240-WW4                | 57-20240-WW4A | -                           | -             | -                          | -             |
|                         | 36   | 57-20360-WW4                | 57-20360-WW4A | -                           | -             | -                          | -             |
|                         | 50   | 57-20500-WW4                | 57-20500-WW4A | -                           | -             | -                          | -             |

**.085 in. (2.16mm)  
Density  
Miniature Ribbon**

Wire Wrap  
Metal Shell and All-Plastic



**All-Plastic**

- All-plastic Wire Wrap connectors are available with .025" sq. or .045" sq. x 1.35" (.56" wrap length) terminals.
- Available with .141" or .125" mounting holes as indicated, for #4 hardware.
- Includes InstaLatch passive latch feature for automatic latching.  
Sockets also available without latches.

See pages 6-4 and 6-52 for recommended panel cutout dimensions.

See pages 6-51 thru 6-52 for accessories such as mounting screws and dust covers, which make the use of Cinch Miniature Ribbon connectors even more cost-effective in panel-mount applications.

**Plug**



**All-Plastic Socket**



**Dimensions, All-Plastic**

| Size | A     |       | B     |       | C     |       | D     |       |
|------|-------|-------|-------|-------|-------|-------|-------|-------|
|      | in    | mm    | in    | mm    | in    | mm    | in    | mm    |
| 14   | 1.745 | 44.32 | 1.417 | 35.99 | 0.710 | 18.03 | 0.510 | 12.95 |
| 24   | 2.170 | 55.12 | 1.842 | 46.79 | 1.135 | 28.83 | 0.935 | 23.75 |
| 36   | 2.680 | 68.07 | 2.352 | 59.74 | 1.645 | 41.78 | 1.445 | 36.70 |
| 50   | 3.275 | 83.19 | 2.947 | 74.85 | 2.240 | 56.90 | 2.040 | 51.82 |
| 64   | 3.875 | 98.43 | 3.542 | 89.97 | 2.835 | 72.01 | 2.635 | 66.93 |

**.085 in. (2.16mm)  
Density  
Miniature Ribbon**

Wire Wrap  
Metal Shell and All-Plastic



**Ordering Information, All-Plastic**

**Plug, InstaLatching**

| Mount     | Size | .025" sq. x 1.35" Terminals |         | .045" sq. x 1.35" Terminals |               |
|-----------|------|-----------------------------|---------|-----------------------------|---------------|
|           |      | Commercial                  | 30Au/Ni | Commercial                  | 30Au/Ni       |
| .140 Hole | 24   | -                           | -       | 97-10240-WW2                | 97-10240-WW2A |
|           | 64   | -                           | -       | 97-10640-WW2                | 97-10640-WW2A |

**Socket**

| Mount      | Size         | .025" sq. x 1.35" Terminals |               | .045" sq. x 1.35" Terminals |               |               |
|------------|--------------|-----------------------------|---------------|-----------------------------|---------------|---------------|
|            |              | Commercial                  | 30Au/Ni       | Commercial                  | 30Au/Ni       |               |
| No latches | .141 Hole    | 14                          | 97-22140-WW5  | 97-22140-WW5A               | 97-22140-WW6  | 97-22140-WW6A |
|            |              | 24                          | 97-22240-WW5  | 97-22240-WW5A               | 97-22240-WW6  | 97-22240-WW6A |
|            | 36           | 97-22360-WW5                | 97-22360-WW5A | 97-22360-WW6                | 97-22360-WW6A |               |
|            | 50           | 97-22500-WW5                | 97-22500-WW5A | 97-22500-WW6                | 97-22500-WW6A |               |
| .159 Hole  | 64           | 97-22640-WW5                | 97-22640-WW5A | 97-22640-WW6                | 97-22640-WW6A |               |
|            | InstaLatches | .141 Hole                   | 14            | 97-22140-WW1                | 97-22140-WW1A | 97-22140-WW2  |
| 24         |              |                             | 97-22240-WW1  | 97-22240-WW1A               | 97-22240-WW2  | 97-22240-WW2A |
| 36         |              | 97-22360-WW1                | 97-22360-WW1A | 97-22360-WW2                | 97-22360-WW2A |               |
| 50         |              | 97-22500-WW1                | 97-22500-WW1A | 97-22500-WW2                | 97-22500-WW2A |               |
| .159 Hole  | 64           | 97-22640-WW1                | 97-22640-WW1A | 97-22640-WW2                | 97-22640-WW2A |               |

**.085 in. (2.16mm)  
Density  
Miniature Ribbon**

Vertical-Mount Solder Tail  
Metal Shell



FEATURES

- **Straight Solder Tails for solder termination to printed circuit board in lengths for use on all standard thickness boards.**
- **Surface Mount Compatible; withstands vapor-phase and IR reflow processes.**
- **Metal shell provides grounding and shielding capability.**
- **Available in plug and socket styles in 14, 24, 36, and 50 position sizes.**
- **All plugs lock with InstaLatch passive latch feature for automatic latching.**
- **Industry-standard bail latch feature available for locking/unlocking without tools in applications such as SCSI-1 and Centronics.**
- **Available, where indicated, with J-Hook latches that automatically lock down mating end-entry connectors.**
- **Available, where indicated, with through-hole or threaded standoffs for improved board mounting.**
- **Sockets available with through holes or with float mounts to provide limited self-alignment.**
- **UL Recognized - Files E170218 (UL1977), E130965 (UL1863).**
- **CSA Approved - File LR31996-7.**

MATERIALS

**Insulator:** Blue UL94V-0 rated diallyl phthalate type MDG, per MIL-M14F  
**Contact:** Copper alloy  
**Contact Plating:** Select gold over 50µin. select nickel standard;  
 30µin. select gold over 50µin. select nickel available where indicated.  
 Gold flash on solder tails  
**Shell:** Steel  
**Shell Plating:** Zinc with clear chromate coating standard. Tin available where indicated.



ENVIRONMENTAL

**Operating Temperature:** -40°C to +105°C  
**Shock:** 50G Peak, per EIA Std. RS364, TP27, Condition A  
**Vibration:** 3 cycles @ 10-55Hz in each of 3 axes per EIA Std. 364, TP28, Condition A  
**Moisture Resistance:** Per EIA Std. RS364, TP31, Condition B, with Step 7B excluded

ELECTRICAL

**Voltage Rating:** 500 VAC @ sea level; 125 VAC @ 70,000 ft.  
**Withstanding Voltage:** 1200 VAC RMS @ sea level, per EIA Std. RS364, TP20  
**Contact Rating:** 5 Amps (4 Amps per CSA)  
**Contact Resistance:** 6 milliohms maximum, per EIA Std. RS364, TP6  
**Insulation Resistance:** 5000 Megohms minimum initial;  
 1000 Megohms minimum after moisture

MECHANICAL

**Durability:** 200 mating/unmating cycles  
**Mating / Unmating Forces:**

| Size | Mating Force (max.) |      | Unmating Force (min.) |      |
|------|---------------------|------|-----------------------|------|
|      | Lb.                 | Kg   | Lb.                   | Kg   |
| 14   | 5                   | 2.27 | 2                     | 0.91 |
| 24   | 8                   | 3.63 | 4                     | 1.81 |
| 36   | 12                  | 5.44 | 6                     | 2.72 |
| 50   | 15                  | 6.80 | 7                     | 3.18 |

**.085 in. (2.16mm)  
Density  
Miniature Ribbon**

Vertical-Mount Solder Tail  
Metal Shell



Plug, InstaLatching

Dimensions

| Size | A     |       | B     |       | C     |       |
|------|-------|-------|-------|-------|-------|-------|
|      | in    | mm    | in    | mm    | in    | mm    |
| 14   | 1.750 | 44.45 | 1.417 | 35.99 | 0.910 | 23.11 |
| 24   | 2.175 | 55.25 | 1.842 | 46.79 | 1.335 | 33.91 |
| 36   | 2.685 | 68.20 | 2.352 | 59.74 | 1.845 | 46.86 |
| 50   | 3.260 | 82.80 | 2.947 | 74.85 | 2.440 | 61.98 |

Plug



J-Hook Latches



Conductive Standoff



Insulated Standoff



Ordering Information, Plug, InstaLatching

| Mount                                  | Size | .110" Tail Length (J)<br>(for PCB thickness up to .062" nominal) |              | .145" Tail Length (J)<br>(for PCB thickness up to .093" nominal) |              | .190" Tail Length (J)<br>(for PCB thickness up to .125" nominal) |               |
|--|------|--|--------------|--|--------------|--|---------------|
|  |      | Commercial   | 30Au/Ni      | Commercial   | 30Au/Ni      | Commercial   | 30Au/Ni       |
| .103 Hole                              | 14   | 57-10140-4   | 57-10140-4A  | 57-10140-5   | 57-10140-5A  | 57-DS14P2-3  | 57-DS14P2-3A  |
|  | 24   | 57-10240-3   | 57-10240-3A  | 57-10240-5   | 57-10240-5A  | 57-10240-12  | 57-10240-12A  |
|  | 36   | 57-10360-13  | 57-10360-13A | 57-10360-17  | 57-10360-17A | 57-10360-25  | 57-10360-25A  |
|  | 50   | 57-10500-27  | 57-10500-27A | 57-10500-46  | 57-10500-46A | 57-10500-73  | 57-10500-73A  |
| .185 Hole                              | 14   | 57-DS14P1-1  | 57-DS14P1-1A | 57-DS14P1-2  | 57-DS14P1-2A | 57-DS14P1-3  | 57-DS14P1-3A  |
|  | 24   | 57-DS24P1-1  | 57-DS24P1-1A | 57-DS24P1-2  | 57-DS24P1-2A | 57-DS24P1-3  | 57-DS24P1-3A  |
|  | 36   | 57-DS36P1-1  | 57-DS36P1-1A | 57-DS36P1-2  | 57-DS36P1-2A | 57-DS36P1-3  | 57-DS36P1-3A  |
|  | 50   | 57-DS50P1-1  | 57-DS50P1-1A | 57-DS50P1-2  | 57-DS50P1-2A | 57-DS50P1-3  | 57-DS50P1-3A  |
| Conductive Standoff<br>.120 (Ref) Hole | 50   | -  | -            | -  | -            | 57-10500-76  | 57-10500-76A  |
| Conductive Standoff<br>4-40 Hole       | 50   | -  | -            | -  | -            | 57-10500-77  | 57-10500-77A  |
| Insulated Standoff<br>.120 (Ref) Hole  | 50   | -  | -            | -  | -            | 57-10500-68  | 57-10500-68A  |
| Insulated Standoff<br>4-40 Hole        | 50   | -  | -            | -  | -            | 57-10500-69  | 57-10500-69A  |
| Conductive Standoff<br>.120 (Ref) Hole | 50   | -  | -            | -  | -            | 57-10500J-76   | 57-10500J-76A |
| Conductive Standoff<br>4-40 Hole       | 50   | -  | -            | -  | -            | 57-10500J-77   | 57-10500J-77A |
| Insulated Standoff<br>.120 (Ref) Hole  | 50   | -  | -            | -  | -            | 57-10500J-68   | 57-10500J-68A |
| Insulated Standoff<br>4-40 Hole        | 50   | -  | -            | -  | -            | 57-10500J-69   | 57-10500J-69A |

J-Hook  
Latches

**.085 in. (2.16mm)  
Density  
Miniature Ribbon**

Vertical-Mount Solder Tail  
Metal Shell



Socket

Dimensions

| Size | A     |       | B     |       | C     |       |
|------|-------|-------|-------|-------|-------|-------|
|      | in    | mm    | in    | mm    | in    | mm    |
| 14   | 1.750 | 44.45 | 1.417 | 35.99 | 0.910 | 23.11 |
| 24   | 2.175 | 55.25 | 1.842 | 46.79 | 1.335 | 33.91 |
| 36   | 2.685 | 68.2  | 2.352 | 59.74 | 1.845 | 46.86 |
| 50   | 3.260 | 82.8  | 2.947 | 74.85 | 2.440 | 61.98 |

Socket with Bail Latches



Bail Latches with Standoffs



Socket with Float Bushing



J-Hook Latches

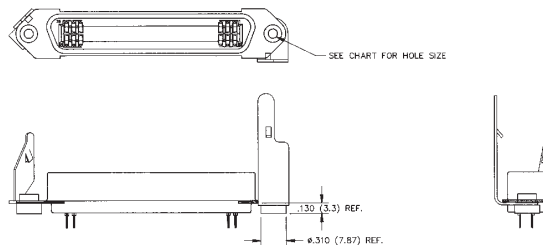

Recommended PCB Hole Layout





**.085 in. (2.16mm)  
Density  
Miniature Ribbon**

Vertical-Mount Solder Tail  
Metal Shell



Socket

Ordering Information

| Latch Mount    | Size                            | .110" Tail Length (J)<br>(for PCB thickness up to .062" nominal) |              | .145" Tail Length (J)<br>(for PCB thickness up to .093" nominal) |              | .190" Tail Length (J)<br>(for PCB thickness up to .125" nominal) |               |               |               |
|----------------|---------------------------------|--|--------------|--|--------------|--|---------------|---------------|---------------|
|                |                                 | Commercial   | 30Au/Ni      | Commercial   | 30Au/Ni      | Commercial   | 30Au/Ni       |               |               |
| No Latches     | Float Mounts with<br>.103 Hole  | 14   | 57-20140-8   | 57-20140-8A  | -            | -  | -             | -             |               |
|                |                                 | 24   | 57-20240-8   | 57-20240-8A  | -            | -  | -             | -             |               |
|                |                                 | 36   | 57-20360-9   | 57-20360-9A  | -            | -  | -             | -             |               |
|                |                                 | 50   | 57-20500-31  | 57-20500-31A   | -            | -  | -             | -             |               |
|                | .185 Hole                       | 14   | 57-20140-12  | 57-20140-12A   | 57-20140-10  | 57-20140-10A   | 57-DS14S1-3   | 57-DS14S1-3A  |               |
|                |                                 | 24   | 57-20240-14  | 57-20240-14A   | 57-20240-11  | 57-20240-11A   | 57-20240-23   | 57-20240-23A  |               |
|                |                                 | 36   | 57-20360-15  | 57-20360-15A   | 57-20360-13  | 57-20360-13A   | 57-20360-19   | 57-20360-19A  |               |
|                |                                 | 50   | 57-20500-65  | 57-20500-65A   | 57-20500-58  | 57-20500-58A   | 57-20500-85   | 57-20500-85A  |               |
|                |                                 | 14   | 57-40140-8   | 57-40140-8A  | 57-40140-11  | 57-40140-11A   | 57-DS14S-3    | 57-DS14S-3A   |               |
|                |                                 | 24   | 57-40240-9   | 57-40240-9A  | 57-40240-11  | 57-40240-11A   | 57-40240-14   | 57-40240-14A  |               |
| Bail Latches   | .116 Hole                       | 36   | 57-40360-12† | 57-40360-12A†  | 57-40360-16† | 57-40360-16A†  | 57-40360-24†  | 57-40360-24A† |               |
|                |                                 | 50   | 57-40500-9   | 57-40500-9A  | 57-40500-16  | 57-40500-16A   | 57-40500-24   | 57-40500-24A  |               |
|                |                                 | Conductive Standoff<br>4-40 Hole                                 |              | 50   | -            | -  | -             | 57-40500-26   | 57-40500-26A  |
|                |                                 | Insulated Standoff<br>.120 (Ref) Hole                            |              | 50   | -            | -  | -             | 57-20500J-78  | 57-20500J-78A |
| J-Hook Latches | Insulated Standoff<br>4-40 Hole | 50   | -            | -  | -            | 57-20500J-79   | 57-20500J-79A |               |               |

† IEEE 1284-B

**.085 in. (2.16mm)  
Density  
Miniature Ribbon**

Vertical-Mount Solder Tail  
All-Plastic



FEATURES

- **Straight Solder Tails for solder termination to printed circuit board.**
- **Available with .145" or .190" tail lengths to suit applications with any thickness PC board.**
- **All-plastic design reduces cost.**
- **Available in plug and socket styles in 14, 24, 36, 50, and 64 position sizes.**
- **All plugs lock with InstaLatch passive latch feature for automatic latching. Sockets available with InstaLatches, with Bail Latches in sizes indicated, or with no latches.**
- **Available with through holes or with #4-40 holes for mounting/latching.**
- **UL Recognized - Files E170218 (UL1977), E130965 (UL1863).**
- **CSA Approved - File LR31996-7.**

MATERIALS

**Insulator:** Gray UL94V-0 rated glass-filled polyester  
**Contact:** Copper Alloy  
**Contact Plating:** Select gold over 50µin. select nickel standard;  
 30µin. select gold over 50µin. select nickel  
 available where indicated. Gold flash on  
 solder tails



ENVIRONMENTAL

**Operating Temperature:** -40°C to +105°C  
**Shock:** 50G Peak, per EIA Std. RS364, TP27, Condition A  
**Vibration:** 3 cycles @ 10-55Hz in each of 3 axes per EIA  
 Std. 364, TP28, Condition A  
**Moisture Resistance:** Per EIA Std. RS364, TP31, Condition B,  
 with Step 7B excluded



ELECTRICAL

**Voltage Rating:** 500 VAC @ sea level; 125 VAC @ 70,000 ft.  
**Withstanding Voltage:** 1200 VAC RMS @ sea level, per EIA  
 Std. RS364, TP20  
**Contact Rating:** 5 Amps (4 Amps per CSA)  
**Contact Resistance:** 6 milliohms maximum, per EIA Std.  
 RS364, TP6  
**Insulation Resistance:** 5000 Megohms minimum initial;  
 1000 Megohms minimum after moisture

MECHANICAL

**Durability:** 200 mating/unmating cycles  
**Mating / Unmating Forces:**

| Size | Mating Force (max.)<br>with InstaLatches |       | Unmating Force (min.)<br>without InstaLatches |      |
|------|--|-------|---|------|
|      | Lb.                                      | Kg    | Lb.   | Kg   |
| 14   | 12                                       | 5.44  | 2   | 0.91 |
| 24   | 17                                       | 7.71  | 4   | 1.81 |
| 36   | 23                                       | 10.43 | 6   | 2.72 |
| 50   | 32                                       | 14.52 | 7   | 3.18 |
| 64   | 37                                       | 16.78 | 8   | 3.63 |

**.085 in. (2.16mm)**  
**Density**  
**Miniature Ribbon**

Vertical-Mount Solder Tail  
 All-Plastic



Vertical-mount Miniature Ribbon connectors provide I/O directly from printed circuit boards, where the mating face of the connector is in a plane parallel to that of the board.

See page 6-51 for accessories such as dust covers, bent bail latches, and mounting screws that make the use of Cinch Miniature Ribbon connectors even more cost-effective in board-mount applications.

**Dimensions**

| Size | A     |       | B     |       |
|------|-------|-------|-------|-------|
|      | in    | mm    | in    | mm    |
| 14   | 1.745 | 44.32 | 1.417 | 35.99 |
| 24   | 2.170 | 55.12 | 1.842 | 46.79 |
| 36   | 2.680 | 68.07 | 2.352 | 59.74 |
| 50   | 3.275 | 83.19 | 2.947 | 74.85 |
| 64   | 3.875 | 98.43 | 3.542 | 89.97 |

**Recommended PCB Hole Layout**



**Socket**



**Plug**



**With InstaLatches**

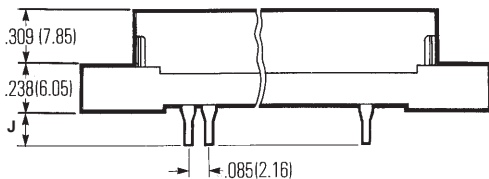

**With Bail Latches**



**.085 in. (2.16mm)  
Density  
Miniature Ribbon**

Vertical-Mount Solder Tail  
All-Plastic



**Ordering Information, Vertical-Mount Solder Tail**

**Plug, InstaLatching**

| Mount      | Size | .138" Tail Length (J)<br>(for PCB thickness<br>up to .093" nominal) |              | .183" Tail Length (J)<br>(for PCB thickness<br>up to .125" nominal) |              |
|------------|------|---|--------------|---|--------------|
|            |      | Commercial  | 30Au/Ni      | Commercial  | 30Au/Ni      |
| .125 Hole  | 14   | 97-DSP14-2  | 97-DSP14-2A  | 97-DSP14-3  | 97-DSP14-3A  |
|            | 24   | 97-DSP24-2  | 97-DSP24-2A  | 97-DSP24-3  | 97-DSP24-3A  |
|            | 36   | 97-DSP36-2  | 97-DSP36-2A  | 97-DSP36-3  | 97-DSP36-3A  |
|            | 50   | 97-DSP50-2  | 97-DSP50-2A  | 97-DSP50-3  | 97-DSP50-3A  |
| #4-40 Hole | 64   | 97-DSP64-2  | 97-DSP64-2A  | 97-DSP64-3  | 97-DSP64-3A  |
|            | 14   | 97-DSP14-12   | 97-DSP14-12A | 97-DSP14-13   | 97-DSP14-13A |
|            | 24   | 97-DSP24-12   | 97-DSP24-12A | 97-DSP24-13   | 97-DSP24-13A |
|            | 36   | 97-DSP36-12   | 97-DSP36-12A | 97-DSP36-13   | 97-DSP36-13A |
|            | 50   | 97-DSP50-12   | 97-DSP50-12A | 97-DSP50-13   | 97-DSP50-13A |
|            | 64   | 97-DSP64-12   | 97-DSP64-12A | 97-DSP64-13   | 97-DSP64-13A |

**Socket**

| Latch Mount | Size                    | .138" Tail Length (J)<br>(for PCB thickness<br>up to .093" nominal) |              | .183" Tail Length (J)<br>(for PCB thickness<br>up to .125" nominal) |              |              |
|-------------|-------------------------|---|--------------|---|--------------|--------------|
|             |                         | Commercial  | 30Au/Ni      | Commercial  | 30Au/Ni      |              |
| No latches  | .125 Hole               | 14  | 97-DSS14-22  | 97-DSS14-22A  | 97-DSS14-23  | 97-DSS14-23A |
|             |                         | 24  | 97-DSS24-22  | 97-DSS24-22A  | 97-DSS24-23  | 97-DSS24-23A |
|             |                         | 36  | 97-DSS36-22  | 97-DSS36-22A  | 97-DSS36-23  | 97-DSS36-23A |
|             |                         | 64  | 97-DSS64-22  | 97-DSS64-22A  | 97-DSS64-23  | 97-DSS64-23A |
|             | .160 Hole               | 50  | 97-DSS50-22  | 97-DSS50-22A  | 97-DSS50-23  | 97-DSS50-23A |
|             |                         | 14  | 97-DSS14-32  | 97-DSS14-32A  | 97-DSS14-33  | 97-DSS14-33A |
|             |                         | 24  | 97-DSS24-32  | 97-DSS24-32A  | 97-DSS24-33  | 97-DSS24-33A |
|             |                         | 36  | 97-DSS36-32  | 97-DSS36-32A  | 97-DSS36-33  | 97-DSS36-33A |
| #4-40 Hole  | 50                      | 97-DSS50-32   | 97-DSS50-32A | 97-DSS50-33   | 97-DSS50-33A |              |
|             | 64                      | 97-DSS64-32   | 97-DSS64-32A | 97-DSS64-33   | 97-DSS64-33A |              |
|             | .125 Hole               | 14  | 97-DSS14-2   | 97-DSS14-2A   | 97-DSS14-3   | 97-DSS14-3A  |
|             |                         | 24  | 97-DSS24-2   | 97-DSS24-2A   | 97-DSS24-3   | 97-DSS24-3A  |
| 36          |                         | 97-DSS36-2  | 97-DSS36-2A  | 97-DSS36-3  | 97-DSS36-3A  |              |
| 64          |                         | 97-DSS64-2  | 97-DSS64-2A  | 97-DSS64-3  | 97-DSS64-3A  |              |
| .160 Hole   | 50                      | 97-DSS50-2  | 97-DSS50-2A  | 97-DSS50-3  | 97-DSS50-3A  |              |
|             | 14                      | 97-DSS14-12   | 97-DSS14-12A | 97-DSS14-13   | 97-DSS14-13A |              |
|             | 24                      | 97-DSS24-12   | 97-DSS24-12A | 97-DSS24-13   | 97-DSS24-13A |              |
|             | 36                      | 97-DSS36-12   | 97-DSS36-12A | 97-DSS36-13   | 97-DSS36-13A |              |
| #4-40 Hole  | 50                      | 97-DSS50-12   | 97-DSS50-12A | 97-DSS50-13   | 97-DSS50-13A |              |
|             | 64                      | 97-DSS64-12   | 97-DSS64-12A | 97-DSS64-13   | 97-DSS64-13A |              |
|             | Bail Latches, .116 Hole | 24  | 97-DSS24-42  | 97-DSS24-42A  | 97-DSS24-43  | 97-DSS24-43A |
|             |                         | 36  | 97-DSS36-42  | 97-DSS36-42A  | 97-DSS36-43  | 97-DSS36-43A |
| 50          |                         | 97-DSS50-42   | 97-DSS50-42A | 97-DSS50-43   | 97-DSS50-43A |              |

**.085 in. (2.16mm)  
Density  
Miniature Ribbon**

Vertical-Mount Compliant Pin  
All-Plastic and Metal Shell



FEATURES

- **Straight Compliant Pin for solderless termination to printed circuit board.**
- **All-plastic design reduces cost. Metal Shell also available where indicated for improved shielding.**
- **Available in plug and socket styles in 14, 24, 36, 50, and 64 position sizes.**
- **All plugs lock with InstaLatch passive latch feature for automatic latching. Sockets available with InstaLatches, with Bail Latches where indicated, or with no latches.**
- **Available with through holes or with #4-40 holes for mounting/latching.**
- **Includes Seating Cover that allows for flat-rock insertion and serves as dust cover after insertion.**
- **UL Recognized - Files E170218 (UL1977), E130965 (UL1863).**
- **CSA Approved - File LR31996-7.**

MATERIALS

**Insulator and Seating Cover:** Gray UL94V-0 rated glass-filled polyester

**Contact:** Phosphor bronze

**Contact Plating:** Select gold over 50µin. select nickel standard; 30µin. select gold over 50µin. select nickel available where indicated. Gold flash in termination area

**Shell (Metal Shell Version Only):** Steel

**Shell Plating (Metal Shell Version Only):** Tin



ENVIRONMENTAL

**Operating Temperature:** -40°C to +105°C

**Shock:** 50G Peak, per EIA Std. RS364, TP27, Condition A

**Vibration:** 3 cycles @ 10-55Hz in each of 3 axes per EIA Std. 364, TP28, Condition A

**Moisture Resistance:** Per EIA Std. RS364, TP31, Condition B, with Step 7B excluded



ELECTRICAL

**Voltage Rating:** 500 VAC @ sea level; 125 VAC @ 70,000 ft.

**Withstanding Voltage:** 1200 VAC RMS @ sea level, per EIA Std. RS364, TP20

**Contact Rating:** 5 Amps (4 Amps per CSA)

**Contact Resistance:** 6 milliohms maximum, per EIA Std. RS364, TP6

**Insulation Resistance:** 5000 Megohms minimum initial; 1000 Megohms minimum after moisture

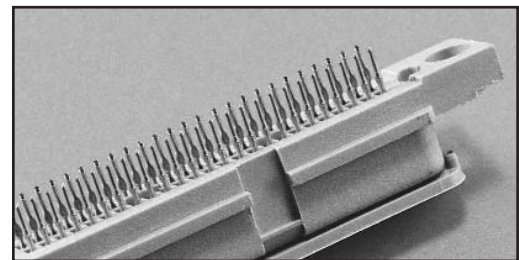

MECHANICAL

**Durability:** 200 mating/unmating cycles

**Mating / Unmating Forces:**

| Size | Mating Force (max.)<br>with InstaLatches |       | Unmating Force (min.)<br>without InstaLatches |      |
|------|--|-------|---|------|
|      | Lb.                                      | Kg    | Lb.   | Kg   |
| 14   | 12                                       | 5.44  | 2   | 0.91 |
| 24   | 17                                       | 7.71  | 4   | 1.81 |
| 36   | 23                                       | 10.43 | 6   | 2.72 |
| 50   | 32                                       | 14.52 | 7   | 3.18 |
| 64   | 37                                       | 16.78 | 8   | 3.63 |

**Connector/PCB Insertion Force (maximum):** 25 lbs (12.3Kg) per contact

**Connector/PCB Retention Force:** 5 lb. (2.44Kg) per contact (minimum, without mounting hardware)

# .085 in. (2.16mm) Density Miniature Ribbon

## Vertical-Mount Compliant Pin All-Plastic and Metal Shell



Vertical-mount Miniature Ribbon connectors provide I/O directly from printed circuit boards, where the mating face of the connector is in a plane parallel to that of the board.

Compliant-pin connectors terminate without solder to plated-through holes in printed circuit boards. The tail conforms to the hole, providing a gas-tight termination without damaging the plating in the printed circuit board.

The seating cover acts as an insertion tool fixture, and *must be left in place until the connector is installed on the PCB*. It may also be left on after insertion to serve as a dust cover to protect the connector from contamination.

See pages 6-51 through 6-53 for accessories such as bent bail latches and mounting screws that make the use of Cinch Miniature Ribbon connectors even more cost-effective in board-mount applications.

### Dimensions

| Size | A     |       | B     |       | C     |       |
|------|-------|-------|-------|-------|-------|-------|
|      | in    | mm    | in    | mm    | in    | mm    |
| 14   | 1.745 | 44.32 | 1.417 | 35.99 | .625  | 15.88 |
| 24   | 2.170 | 55.12 | 1.842 | 46.79 | 1.050 | 26.67 |
| 36   | 2.680 | 68.07 | 2.352 | 59.74 | 1.560 | 39.62 |
| 50   | 3.275 | 83.19 | 2.947 | 74.85 | 2.155 | 54.74 |
| 64   | 3.875 | 98.43 | 3.542 | 89.97 | 2.750 | 69.85 |

### Plug

### Socket with Bail Latches



### Socket with InstaLatches



### Recommended PCB Hole Layout



### Insertion Fixture Backer Plate



**.085 in. (2.16mm)  
Density  
Miniature Ribbon**

Vertical-Mount Compliant Pin  
All-Plastic and Metal Shell



**Ordering Information, Vertical-Mount Compliant Pin**

**All-Plastic Plug, InstaLatching**

| Mount      | Size | Commercial | 30Au/Ni    |
|------------|------|------------|------------|
| .125 Hole  | 14   | 97-CP-14   | 97-CP-14A  |
|            | 24   | 97-CP-24   | 97-CP-24A  |
|            | 36   | 97-CP-36   | 97-CP-36A  |
|            | 50   | 97-CP-50   | 97-CP-50A  |
|            | 64   | 97-CP-64   | 97-CP-64A  |
| #4-40 Hole | 14   | 97-CP-14T  | 97-CP-14TA |
|            | 24   | 97-CP-24T  | 97-CP-24TA |
|            | 36   | 97-CP-36T  | 97-CP-36TA |
|            | 50   | 97-CP-50T  | 97-CP-50TA |
|            | 64   | 97-CP-64T  | 97-CP-64TA |

**All-Plastic Socket**

|              | Latch Mount | Size | Commercial | 30Au/Ni     |
|--------------|-------------|------|------------|-------------|
| No latches   | .160 Hole   | 14   | 97-CS-14   | 97-CS-14A   |
|              |             | 24   | 97-CS-24   | 97-CS-24A   |
|              |             | 36   | 97-CS-36   | 97-CS-36A   |
|              |             | 50   | 97-CS-50   | 97-CS-50A   |
|              |             | 64   | 97-CS-64   | 97-CS-64A   |
|              | #4-40 Hole  | 14   | 97-CS-14T  | 97-CS-14TA  |
|              |             | 24   | 97-CS-24T  | 97-CS-24TA  |
|              |             | 36   | 97-CS-36T  | 97-CS-36TA  |
|              |             | 50   | 97-CS-50T  | 97-CS-50TA  |
|              |             | 64   | 97-CS-64T  | 97-CS-64TA  |
| InstaLatches | .160 Hole   | 14   | 97-CSI-14  | 97-CSI-14A  |
|              |             | 24   | 97-CSI-24  | 97-CSI-24A  |
|              |             | 36   | 97-CSI-36  | 97-CSI-36A  |
|              |             | 50   | 97-CSI-50  | 97-CSI-50A  |
|              |             | 64   | 97-CSI-64  | 97-CSI-64A  |
|              | #4-40 Hole  | 14   | 97-CSI-14T | 97-CSI-14TA |
|              |             | 24   | 97-CSI-24T | 97-CSI-24TA |
|              |             | 36   | 97-CSI-36T | 97-CSI-36TA |
|              |             | 50   | 97-CSI-50T | 97-CSI-50TA |
|              |             | 64   | 97-CSI-64T | 97-CSI-64TA |
| Bail latches | .116 Hole   | 14   | 97-CSB-14  | 97-CSB-14A  |
|              |             | 24   | 97-CSB-24  | 97-CSB-24A  |
|              |             | 36   | 97-CSB-36  | 97-CSB-36A  |
|              |             | 50   | 97-CSB-50  | 97-CSB-50A  |
|              |             | 64   | 97-CSB-64  | 97-CSB-64A  |

**Metal Shell Socket, with InstaLatches**

|                                    |    | Commercial | 30Au/Ni    |
|------------------------------------|----|------------|------------|
| Conductive Standoff with .120 Hole | 50 | 57-CSI-50  | 57-CSI-50A |

**.085 in. (2.16mm)  
Density  
Miniature Ribbon**

Right-Angle Solder Tail  
Metal Shell



FEATURES

- **Right-Angle Solder Tails for solder termination to printed circuit board.**
- **Metal shell provides grounding and shielding capability.**
- **Available in plug and socket styles in 14, 24, 36, and 50 position sizes.**
- **Sockets available with industry-standard bail latch feature for positive locking/unlocking without tools, for applications such as SCSI-1 and Centronics.**
- **#4-40 threaded board mounting holes provide means to secure and ground connector to board.**
- **UL Recognized - File E170218.**

MATERIALS

**Insulator:** Blue UL94V-0 rated glass-filled polyester  
**Contact:** Phosphor bronze  
**Contact Plating:** Select gold over nickel in mating area as indicated; tin-lead on solder tails  
**Shell:** Steel  
**Shell Plating:** Nickel



ENVIRONMENTAL

**Operating Temperature:** -55°C to +105°C



ELECTRICAL

**Withstanding Voltage:** 1000 VAC RMS @ sea level  
**Contact Rating:** 5 Amps  
**Contact Resistance:** 30 milliohms maximum  
**Insulation Resistance:** 1000 Megohms minimum



Right-Angle Miniature Ribbon connectors provide I/O directly from printed circuit boards, where the mating face of the connector is perpendicular to the board. It is well-suited to front-panel I/O on plug-in cards, rear-I/O from system/peripheral motherboards, etc.

See page 6-51 for accessories such as dust covers, bent bail latches and mounting screws that make the use of Cinch Miniature Ribbon connectors even more cost-effective in board-mount applications.



**.085 in. (2.16mm)  
Density  
Miniature Ribbon**

**Right-Angle Solder Tail  
Metal Shell**



**Dimensions**

| Size | A     |       | B     |       | C     |       | D     |       |
|------|-------|-------|-------|-------|-------|-------|-------|-------|
|      | in    | mm    | in    | mm    | in    | mm    | in    | mm    |
| 14   | 1.720 | 43.70 | 1.417 | 35.99 | 0.992 | 25.20 | 1.008 | 25.60 |
| 24   | 2.146 | 54.50 | 1.842 | 46.79 | 1.417 | 36.00 | 1.436 | 36.00 |
| 36   | 2.661 | 67.60 | 2.352 | 59.74 | 1.925 | 48.90 | 1.943 | 49.35 |
| 50   | 3.260 | 82.80 | 2.947 | 74.85 | 2.520 | 64.00 | 2.538 | 64.00 |

**Socket**



**Plug**



**Ordering Information, Right-Angle Solder Tail**

**Plug, 4-40 Board Mount**

| Size | Flash      | 15Au/Ni     | 30Au/Ni     |
|------|------------|-------------|-------------|
| 36   | 57-LRP36-F | 57-LRP36-15 | 57-LRP36-30 |
| 50   | 57-LRP50-F | 57-LRP50-15 | 57-LRP50-30 |

**Socket, 4-40 Board Mount**

| Latch      | Size | Flash        | 15Au/Ni       | 30Au/Ni       |
|------------|------|--------------|---------------|---------------|
| No Latches | 14   | 57-LRS14-F   | 57-LRS14-15   | 57-LRS14-30   |
|            | 24   | 57-LRS24-F   | 57-LRS24-15   | 57-LRS24-30   |
|            | 36   | 57-LRS36-F   | 57-LRS36-15   | 57-LRS36-30   |
|            | 50   | 57-LRS50-F   | 57-LRS50-15   | 57-LRS50-30   |
| Bail Latch | 14   | 57-LRS14-BF  | 57-LRS14-B15  | 57-LRS14-B30  |
|            | 24   | 57-LRS24-BF  | 57-LRS24-B15  | 57-LRS24-B30  |
|            | 36   | 57-LRS36-BF† | 57-LRS36-B15† | 57-LRS36-B30† |
|            | 50   | 57-LRS50-BF  | 57-LRS50-B15  | 57-LRS50-B30  |

† IEEE 1284-B

**.085 in. (2.16mm)  
Density  
Miniature Ribbon**

Filtered  
Vertical-Mount Solder Tail  
and Male/Female Adapter



FEATURES

- Low-pass (single-pole, capacitive) filtered contacts reduce inbound and outbound conducted EMI standard capacitance values of 50pF through 1,200pF.
- Saves space by incorporating required filter functions directly into footprint of I/O connector.
- Available as straight Solder Tail plug for solder termination to printed circuit board (nominal thickness through .093") and as plug/socket adapter, in 50-position size.
- All-plastic design reduces cost.
- All plugs lock with InstaLatch passive latch feature for automatic latching.
- Adapters available with InstaLatches, with Bail Latches, or with no latches on socket side.
- Available with through holes, #4-40 holes, #6-32 holes, or M3 holes for mounting/latching.

MATERIALS

**Insulator:** Gray UL94V-0 rated glass-filled polyester  
**Contact:** Copper alloy  
**Contact Plating:** 30µin. select gold over 50µin. select nickel standard; tin-lead on solder tails  
**Mounting Hardware Plating:** Tin-lead



ENVIRONMENTAL

**Operating Temperature:** -50°C to +105°C  
**Shock:** 50G Peak, per EIA Std. RS364, TP27, Condition A  
**Vibration:** 3 cycles @ 10-55Hz in each of 3 axes per EIA Std. 364, TP28, Condition A  
**Moisture Resistance:** Per EIA Std. RS364, TP31, Condition B, with Step 7B excluded



ELECTRICAL

**Voltage Rating:** 500VDC @ sea level  
**Contact Rating:** 3 Amps  
**RF Current Rating:** 0.3 Amps  
**Leakage Current:** 10mA maximum per contact when subjected to 1000 VAC test voltage, applied over 30 seconds and held for 60 seconds per FCC Part 68.5  
**Voltage Surge:** Withstands 1,500V peak longitudinal voltage surge with 10µsec. risetime, 160µsec. decay  
**Contact Resistance:** 6 milliohms maximum, per EIA Std. RS364, TP6  
**Insulation Resistance:** 5000 Megohms minimum  
**Dissipation Factor:** 5% maximum @ 25°C, 1kHz and 1 VAC RMS maximum

**Insertion Loss:**

| Capacitance<br>@ 25°C, 1kHz, 1 VAC RMS max. | Insertion Loss, min. (dB, @ 25°C, @ 50 ohm, no load, per MIL-STD-220) |       |       |       |        |        |      |
|---|---|-------|-------|-------|--------|--------|------|
|   | 10MHz   | 30MHz | 50MHz | 70MHz | 100MHz | 500MHz | 1GHz |
| 50pF±15%                                    | -   | -     | -     | -     | 2      | 14     | 11   |
| 100pF±15%                                   | -   | -     | -     | -     | 3      | 14     | 11   |
| 220pF±15%                                   | -   | -     | 4     | 7     | 12     | 14     | 11   |
| 470pF±15%                                   | -   | 5     | 11    | 14    | 20     | 14     | 11   |
| 820pF±15%                                   | 3   | 3     | 16    | 20    | 20     | 14     | 11   |
| 1,000pF±15%                                 | 3   | 3     | 16    | 20    | 20     | 14     | 11   |
| 1,200pF±15%                                 | 3   | 3     | 16    | 20    | 20     | 14     | 11   |

MECHANICAL

**Durability:** 200 mating/unmating cycles  
**Mating / Unmating Forces:**

| Size | Mating Force (max.)<br>with InstaLatches |       | Unmating Force (min.)<br>without InstaLatches |      |
|------|--|-------|---|------|
|      | Lb.                                      | Kg    | Lb.   | Kg   |
| 50   | 32                                       | 14.52 | 7   | 3.18 |

**.085 in. (2.16mm)  
Density  
Miniature Ribbon**

**Filtered  
Vertical-Mount Solder Tail  
and Male/Female Adapter**



**Filtered Vertical-Mount Solder Tail Plug**

Vertical-mount Filtered Miniature Ribbon plugs provide filtered I/O directly from printed circuit boards, where the mating face of the connector is in a plane parallel to that of the board. Filtering keeps conducted EMI from passing between the system board and I/O cable.

The connector's filter must be grounded to the system at the mounting holes, via either top flange or through the lower standoff to a pad on the component side of the printed circuit board.

See page 6-51 for accessories such as dust covers and mounting screws that make the use of Cinch Filtered Miniature Ribbon connectors even more cost-effective in board-mount applications.



**Ordering Information, Filtered Vertical-Mount Solder Tail Plug, 50 Position**

|                             | Capacitance | .144 Hole    | #4-40 Hole   | #6-32 Hole   | M3 -0.5 Hole |
|-----------------------------|-------------|--------------|--------------|--------------|--------------|
| Through or<br>threader hole | 50pF±15%    | CF97-50PB-TH | CF97-50PB-4T | CF97-50PB-6T | CF97-50PB-3T |
|                             | 100pF±15%   | CF97-50PC-TH | CF97-50PC-4T | CF97-50PC-6T | CF97-50PC-3T |
|                             | 220pF±15%   | CF97-50PD-TH | CF97-50PD-4T | CF97-50PD-6T | CF97-50PD-3T |
|                             | 470pF±15%   | CF97-50PE-TH | CF97-50PE-4T | CF97-50PE-6T | CF97-50PE-3T |
|                             | 820pF±15%   | CF97-50PF-TH | CF97-50PF-4T | CF97-50PF-6T | CF97-50PF-3T |
|                             | 1,000pF±15% | CF97-50PH-TH | CF97-50PH-4T | CF97-50PH-6T | CF97-50PH-3T |
|                             | 1,200pF±15% | CF97-50PJ-TH | CF97-50PJ-4T | CF97-50PJ-6T | CF97-50PJ-3T |
| Threaded<br>Boardlock       | 50pF±15%    | -            | CF97-50PB-4B | CF97-50PB-6B | CF97-50PB-3B |
|                             | 100pF±15%   | -            | CF97-50PC-4B | CF97-50PC-6B | CF97-50PC-3B |
|                             | 220pF±15%   | -            | CF97-50PD-4B | CF97-50PD-6B | CF97-50PD-3B |
|                             | 470pF±15%   | -            | CF97-50PE-4B | CF97-50PE-6B | CF97-50PE-3B |
|                             | 820pF±15%   | -            | CF97-50PF-4B | CF97-50PF-6B | CF97-50PF-3B |
|                             | 1,000pF±15% | -            | CF97-50PH-4B | CF97-50PH-6B | CF97-50PH-3B |
|                             | 1,200pF±15% | -            | CF97-50PJ-4B | CF97-50PJ-6B | CF97-50PJ-3B |

**.085 in. (2.16mm)  
Density  
Miniature Ribbon**

**Filtered  
Vertical-Mount Solder Tail  
and Male/Female Adapter**



**Filtered Panel Mount Feedthrough Adapter**

Filtered Ribbon Panel Mount Adapters provide filtered I/O in systems where internal cabling carries signals to the system panel.

By filtering right at the panel, EMI that could otherwise be generated over the length of the internal cable is prevented. The use of a plug/socket adapter also yields a benefit in serviceability. Should it ever be necessary to replace the filter, an adapter can be readily replaced without replacing a bulky, more expensive cable assembly.

The adapter must be grounded to the system panel through the mounting hardware, which extends to both plug and socket flanges; thus, the adapter may be mounted with either side to the panel.

Adapters are also available without filter capacitors. Often referred to as “connector savers”, these devices are most useful as “throw away” intermediate interconnects in applications where numerous mating/unmating cycles are required.

See page 6-51 for accessories such as bent bail latches, dust covers, and mounting screws that make the use of Cinch Miniature Ribbon Filtered Adapters even more cost-effective in panel mount-applications.



**Ordering Information, Filtered Adapter, 50 position**

|                          | Capacitance            | #4-40 Hole    | #6-32 Hole    | M3 -0.5 Hole  |
|--------------------------|------------------------|---------------|---------------|---------------|
| Socket without latches   | None (Connector Saver) | CF97-50AA-4T  | CF97-50AA-6T  | CF97-50AA-3T  |
|                          | 50pF±15%               | CF97-50AB-4T  | CF97-50AB-6T  | CF97-50AB-3T  |
|                          | 100pF±15%              | CF97-50AC-4T  | CF97-50AC-6T  | CF97-50AC-3T  |
|                          | 220pF±15%              | CF97-50AD-4T  | CF97-50AD-6T  | CF97-50AD-3T  |
|                          | 470pF±15%              | CF97-50AE-4T  | CF97-50AE-6T  | CF97-50AE-3T  |
|                          | 820pF±15%              | CF97-50AF-4T  | CF97-50AF-6T  | CF97-50AF-3T  |
|                          | 1,000pF±15%            | CF97-50AH-4T  | CF97-50AH-6T  | CF97-50AH-3T  |
|                          | 1,200pF±15%            | CF97-50AJ-4T  | CF97-50AJ-6T  | CF97-50AJ-3T  |
| Socket with InstaLatches | None (Connector Saver) | CF97-50AA-4TI | CF97-50AA-6TI | CF97-50AA-3TI |
|                          | 50pF±15%               | CF97-50AB-4TI | CF97-50AB-6TI | CF97-50AB-3TI |
|                          | 100pF±15%              | CF97-50AC-4TI | CF97-50AC-6TI | CF97-50AC-3TI |
|                          | 220pF±15%              | CF97-50AD-4TI | CF97-50AD-6TI | CF97-50AD-3TI |
|                          | 470pF±15%              | CF97-50AE-4TI | CF97-50AE-6TI | CF97-50AE-3TI |
|                          | 820pF±15%              | CF97-50AF-4TI | CF97-50AF-6TI | CF97-50AF-3TI |
|                          | 1,000pF±15%            | CF97-50AH-4TI | CF97-50AH-6TI | CF97-50AH-3TI |
|                          | 1,200pF±15%            | CF97-50AJ-4TI | CF97-50AJ-6TI | CF97-50AJ-3TI |
| Socket with Bail latches | None (Connector Saver) | CF97-50AA-4TB | CF97-50AA-6TB | CF97-50AA-3TB |
|                          | 50pF±15%               | CF97-50AB-4TB | CF97-50AB-6TB | CF97-50AB-3TB |
|                          | 100pF±15%              | CF97-50AC-4TB | CF97-50AC-6TB | CF97-50AC-3TB |
|                          | 220pF±15%              | CF97-50AD-4TB | CF97-50AD-6TB | CF97-50AD-3TB |
|                          | 470pF±15%              | CF97-50AE-4TB | CF97-50AE-6TB | CF97-50AE-3TB |
|                          | 820pF±15%              | CF97-50AF-4TB | CF97-50AF-6TB | CF97-50AF-3TB |
|                          | 1,000pF±15%            | CF97-50AH-4TB | CF97-50AH-6TB | CF97-50AH-3TB |
|                          | 1,200pF±15%            | CF97-50AJ-4TB | CF97-50AJ-6TB | CF97-50AJ-3TB |

# .085 in. (2.16mm) Density Miniature Ribbon

## Accessories



The following accessories are available to make your application using Cinch Miniature Ribbon and SUPERIBBON products as complete and cost-effective as possible.

### Dust Covers for all Metal Shell and All-Plastic Miniature Ribbon Connectors

Dust covers may be added to Miniature Ribbon or SUPERIBBON assemblies to protect the mating area from damage or contamination when the connector is left unmated. They can be useful for protection from handling damage during assembly, or can be left on the connector for protection of unused system I/O ports.

Compliant-pin Miniature Ribbon products come with special seating fixtures that must be used to install the connectors onto the printed circuit board. These may be replaced after insertion; however, with standard dust covers to maintain the standard color code, if so desired. Material: UL94V-0 rated polyethelene (blue for plug covers; red for socket covers)



### Ordering Information, Dust Covers

| Size | Plug Cover | Socket Cover |
|------|------------|--------------|
| 14   | 57-1001    | 57-1002      |
| 24   | 57-1003    | 57-1004      |
| 36   | 57-1005    | 57-1006      |
| 50   | 57-1008    | 57-1022      |
| 64   | 57-1009    | 57-1010      |

### Bent Bail Latch for End-Entry Applications

Standard Bail Latches will not lock under a plug cable in a typical end-entry application. This latch, which is bent at a 90° angle, may be used to replace a standard latch in this situation.

Material: Stainless Steel

### Ordering Information, Bent Bail Latch

Part No. 57-BL-90



### Mounting Screws and Related Hardware

Many Cinch Miniature Ribbon and SUPERIBBON products include all the hardware required for the most common application for the product; however, these alternatives may be desirable to better fit product to a specific use.

| Part No.        | Description                              | Typical Applications  |
|-----------------|--|---|
| 4-40UNC2AX11/32 | #4-40 x .343 Pan Head Screw              | <ul style="list-style-type: none"> <li>SUPERIBBON to mate with female screwlock</li> <li>PC Mount connector to PCB (secured from rear)</li> </ul>   |
| 4-40UNC2AX17/32 | #4-40 x .525 Pan Head Screw              | <ul style="list-style-type: none"> <li>SUPERIBBON to threaded panel</li> </ul>  |
| 4-40UNC2AX5/8   | #4-40 x .625 Fillister Head Screw        | <ul style="list-style-type: none"> <li>Metal Shell Running Cable (included on standard end-entry metal shell products)</li> </ul>   |
| 4-40UNC2AX3/4   | #4-40 x .750 Pan Head Screw              | <ul style="list-style-type: none"> <li>SUPERIBBON Running Cable (included on standard end-entry SUPERIBBON products)</li> <li>SUPERIBBON to front-panel mounted SUPERIBBON held by panel clips</li> </ul> |
| 4-40UNC2AX7/8   | #4-40 x .875                             | <ul style="list-style-type: none"> <li>Miscellaneous</li> </ul>   |
| 4-40X1/4SPCR    | Hex Spacer, #4-40 Internal Thread x .250 | <ul style="list-style-type: none"> <li>Female Screwlock</li> </ul>  |



**.085 in. (2.16mm)  
Density  
Miniature Ribbon**

Accessories



**Wire Restraints for Panel-Mount SUPERIBBON™ All-Plastic Connectors**

Wire restraints provide added security to terminated wires, preventing radial pullout. They are intended for use on panel mounted connectors where hoods are not required (wire restraints cannot be applied simultaneously with hoods), and snap on after connector termination.

Material: Gray UL94V-0 rated polyester.



**Ordering Information, SUPERIBBON Wire Restraints**

(Two restraints required per connector)

| Size | Plug      | Socket    |
|------|-----------|-----------|
| 14   | 97-WR-P14 | 97-WR-S14 |
| 24   | 97-WR-P24 | 97-WR-S24 |
| 36   | 97-WR-P36 | 97-WR-S36 |
| 50   | 97-WR-P50 | 97-WR-S50 |
| 64   | 97-WR-P64 | 97-WR-S64 |

**Wire Restraints for Panel-Mount Miniature Ribbon Metal Shell Connectors**

Metal Shell Wire Restraints serve the same purpose as their SUPERIBBON counterparts, but are for IDC terminated metal shell connectors. These one-piece restraints snap in place around the termination area after assembly.

Material: Blue UL94V-0 rated polyester.



**Ordering Information, Miniature Ribbon Wire Restraints**

(One restraint required per connector)

| Size | Plug or Socket |
|------|----------------|
| 36   | 77-WR-36       |
| 50   | 77-WR-50       |

**Panel Mounting Clips for All-Plastic Miniature Ribbon Connectors**

These clips slip into each end of a modified panel cutout, and allow all-plastic Miniature Ribbon connectors to be snapped into place and securely front-mounted to the panel with no additional hardware. Threaded holes are not required in the panel, and connectors can be loaded without needing access to the rear of the panel.

Material: Steel

Finish: Tin-cadmium/clear chromate



**Ordering Information, Panel Mounting Clips**

(Two clips required per connector)

| Chassis Thickness | Panel Clip Part Number |
|-------------------|------------------------|
| .062" (1.57mm)    | 97-MC-062              |
| .093" (2.36mm)    | 97-MC-093              |
| .125" (3.18mm)    | 97-MC-125              |

**Dimensions**

| Size | B     |       | K     |       |
|------|-------|-------|-------|-------|
|      | in    | mm    | in    | mm    |
| 14   | 1.417 | 35.99 | 1.060 | 26.92 |
| 24   | 1.842 | 46.79 | 1.485 | 37.72 |
| 36   | 2.352 | 59.74 | 1.995 | 50.67 |
| 50   | 2.947 | 74.85 | 2.590 | 65.79 |
| 64   | 3.542 | 89.97 | 3.185 | 80.90 |



**.085 in. (2.16mm)  
Density  
Miniature Ribbon**

Accessories



**Wire Restraint with Integral Panel Clip**

This accessory for All-Plastic Miniature Ribbon products combines the Wire Restraint and Panel Mounting Clip into one molded device. Available only for 50 position size connectors, it provides a significant material and labor cost savings compared to alternate mounting methods.

Material: Gray UL94V-0 rated polyester.



**Ordering Information, Wire Restraint with Integral Panel Clip  
(Two required per connector)**

| Chassis Thickness | Panel Clip Part Number |
|-------------------|------------------------|
| .062" (1.57mm)    | 97-WRC-062             |
| .093" (2.36mm)    | 97-WRC-093             |

**Hoods for SUPERIBBON Connectors**

180° (Top-Entry) Hoods can be used with panel-mount All-Plastic SUPERIBBON connectors to provide strain relief and protection of the wire terminations. The two-piece snap-on assembly has adjustable tabs that allow effective strain relief on a wide range of cable sizes.

90°/270° (End-Entry) Hoods are for replacement on End-Entry SUPERIBBON connectors. They are available for all sizes, as well as for the pointed-nose 50 position size. *Note: End-Entry Hoods cannot be added to panel-mount connectors because the finished assembly would not have the end-entry cable grip. See pages 6-10 thru 6-13 for complete end-entry connectors.*

Material: Gray UL94V-0 rated polyester.



**Ordering Information, Hoods for All-Plastic Miniature Ribbon**

|              | Size | 180° (Top-Entry) | 90°/270° (End-Entry) |
|--------------|------|------------------|----------------------|
|              | 14   | 97-14-180        | 97-14-90             |
| Square       | 24   | 97-24-180        | 97-24-90             |
| Nose         | 36   | 97-36-180        | 97-36-90             |
|              | 50   | 97-50-180        | 97-50-90             |
|              | 64   | 97-64-180        | 97-64-90             |
| Pointed Nose | 50   | -                | 97-50-90P            |



**.085 in. (2.16mm)  
Density  
Miniature Ribbon**

Application Tools



A full range of tooling is available to make the use of Cinch Miniature Ribbon and SUPERIBBON™ products as cost-effective as possible. From hand repair tools to the high production rate Auto-Clinch™ termination tool, Cinch has the tool to fit your needs.

**Auto-Clinch Model 200S Termination Tool**

Auto-Clinch is a semi-automatic Connector Termination Machine that terminates IDC connectors pair-by-pair. The basic machine comes equipped ready to terminate 50-position end-entry Miniature Ribbon or SUPERIBBON connectors, which it can do in approximately 1.5 minutes.



The Auto-Clinch is pneumatically powered and requires a min. 60psi air supply. It is electrically controlled, and requires a 117V, 60Hz Single Phase electrical circuit (5 Amps). Weight: 120 lbs. (54.48kg.), Dimensions: 25.5" (64.77cm.) wide; 20" (50.8cm) deep; 9" (22.86cm) high. *Note: These specifications may change with the addition of certain options.*

**Order Part No. AC-371**

Several options are available that make the Auto-Clinch a versatile application tool:

- Remote Visual Color Display shows wire color codes. It can be used to train new operators or to assist the operator in terminating non-standard wire sequences. **Part No. ACO-482**
- The Selective Programmer allows the operator to set the machine to skip over positions that are not to be terminated, thus speeding up the termination process. **Part No. ACO-495**
- The End-Entry Cable Clamp closer automatically closes the cable clamp on end-entry SUPERIBBON or SuperShield connectors as they are terminated. **Part No. ACO-374**  
A power assist for this device is also available. **Part No. ACO-405**
- The Top-Entry Adapter dresses the wires during termination such that they are properly aligned for exit through a Top-Entry hood. **Part No. ACO-218**  
*NOTE: Auto-Clinch™ cannot be equipped with both Cable Clamp Closer and Top-Entry Adapter simultaneously.*
- Insertion Blades are included for terminating solid wire. For replacement, order **Part No. ACB-443**  
To terminate stranded wire, order stranded-wire blades, **Part No. ACB-872**
- Nests for Panel Mount and Top-Entry Ribbon Connectors, and All Plastic SUPERIBBON connectors allow the use of Auto-Clinch to terminate other IDC Ribbon Connectors:

| Connector Size | For All-Plastic IDC Connectors |           |           | For Metal-Shell IDC Connectors |                 |                           |
|----------------|--------------------------------|-----------|-----------|--------------------------------|-----------------|---------------------------|
|                | End-Entry                      | Top-Entry | End-Entry | Panel Mount/Top-Entry Sockets  | Top-Entry Plugs | Top-Entry Plug With Hood* |
| 14             | ACEN-850                       | ACTN-568  | -         | ACMN-231                       | -               | ACMN-232                  |
| 24             | ACEN-851                       | ACTN-569  | -         | ACMN-229                       | -               | ACMN-230                  |
| 36             | ACEN-852                       | ACTN-797  | -         | ACMN-228                       | ACMN-203        | ACMN-227                  |
| 50             | ACEN-853                       | ACTN-798  | ACMN-484  | ACMN-527                       | ACMN-858        | ACMN-526                  |
| 64             | ACEN-570                       | ACTN-799  | -         | -                              | -               | -                         |

\* For Bail-Latch plugs with hood where hood forms rear of connector body, i.e., 77-32500.  
For overmold kits, use panel mount/top-entry plug nests.

AutoClinch is a trademark of Cinch Connector Division of Labinal Components & Systems, Inc.



# .085 in. (2.16mm) Density Miniature Ribbon

## Application Tools



### Certi-Clinch™ Portable Termination Tool

Certi-Clinch is a portable, manually operated tool that terminates Cinch all-plastic and metal shell Miniature Ribbon connectors with discrete-wire IDC contacts. It is designed for field use assembling cables on-site, yet is efficient enough to fit well into lower-volume factory assembly operations.

Its 10.5 lb. (4.77Kg) weight and versatile configuration make it readily portable for field use, and allow temporary use with virtually no setup time to handle peak demands in factory environments. A leather case is available for carrying Certi-Clinch onto a job site or for storing Certi-Clinch in the factory when not being used.

Certi-Clinch measures 6" (15.24cm) wide x 13" (33.02cm) long x 6.5" (16.5cm) high.



### Ordering Information, Certi-Clinch

| <u>Model</u> | <u>Description</u>  |
|--------------|---|
| SCT-330      | Certi-Clinch Tool with 25-pair nest, for Solid Wire       |
| SCT-335      | Certi-Clinch Tool with 32-pair nest, for Solid Wire       |
| SCT-360      | Certi-Clinch Tool with 25-pair nest, for Stranded Wire    |
| SCT-342      | Kit to convert 25-pair tool to 32-pair operation          |
| SCT-343      | Kit to convert 32-pair tool to 25-pair operation          |
| SCT-645      | Insertion Blades to convert 25-pair tool to Stranded Wire |
| SCT-038      | Insertion Blades to convert 32-pair tool to Stranded Wire |
| SCT-649      | Carrying Case for all Certi-Clinch Tools                  |

### Handi-Clinch™ Hand Termination Tool

This hand-operated tool terminates wires individually to Cinch SUPERIBBON™ and metal shell Miniature Ribbon IDC connectors. Its integral nest holds the connector in place during use. **Part No. HCTT-539**



### Versa-Clinch™ Multi-Function Hand Tool

This versatile tool performs four basic functions in applying Cinch SUPERIBBON and metal shell Miniature Ribbon products:

- Terminate individual wires to the IDC contact
- Unlatch the hood for removal on end-entry SUPERIBBON products
- Open and close the cable clamp on SUPERIBBON and SuperShield
- Unlock InstaLatches to unmate connectors

**Part No. VCTT-361**



**.085 in. (2.16mm)  
Density  
Miniature Ribbon**

Application Tools



**Termination Repair Pliers**

These plier type tools allow you to rework misterminated cable assemblies and/or perform specialized termination operations. They terminate wires individually into Cinch IDC contacts. Repair Pliers for Standard Termination: **Part No. SRT-345**

Repair Pliers for Half-Tap (Daisy-Chaining) allows you to terminate one wire to multiple contacts to short contacts together, or even to two separate connectors to make back/back connections, etc. **Part No. HT-560**



**InstaLatch™ Unlatching Tool**

While InstaLatches may be unlocked with something as simple as a center punch or ballpoint pen, this tool provides a “hooked” end that allows you to unlock InstaLatches even in tight areas. **Part No. UT-304**



**Crimping Tools for Overmold Kit Ferrules**

Two model tools are available to crimp ferrules onto overmold kits:

- Pneumatically powered bench-top press, which is portable so it can be placed in storage when not required. **Part No. FCT-551**
- Hand-operated crimping tool, satisfactory for lower-volume applications. **Part No. FCT-552**

Both tools use the same crimp dies. Select the crimp die(s) below for the particular ferrule being used (ferrules shown on page 6-22).



| Crimp Die<br>Part No. | Crimp Ferrule<br>Part No. |
|-----------------------|---------------------------|
| CD08                  | CF57                      |
| CD09                  | CF60                      |
| CD10                  | CF64                      |

